



**UNIVERSITY OF NOVI SAD**  
**Technical faculty "Mihajlo Pupin"**  
**Zrenjanin, Republic of Serbia**

**In cooperation with partners**

*Industrial Engineering  
and  
Environmental Protection*

**I I Z S**

*conference*

**2013**

**PROCEEDINGS**

**III International Conference –  
Industrial Engineering and Environmental  
Protection (IIZS 2013)**

Zrenjanin Town Hall  
Zrenjanin, 30<sup>th</sup> October 2013.



University of Novi Sad  
Technical faculty “Mihajlo Pupin”  
Zrenjanin, Republic of Serbia



# **III International Conference Industrial Engineering and Environmental Protection (IIZS 2013)**

Proceedings

Zrenjanin, 30<sup>th</sup> October 2013.

**IN COOPERATION WITH PARTNERS:**

**UNIVERSITY OF AGRICULTURE, FACULTY OF AGRICULTURAL  
ENGINEERING , KRAKOW, POLAND**



**TECHNICAL UNIVERSITY-SOFIA, PLOVDIV BRANCH, THE FACULTY OF  
MECHANICAL ENGINEERING, PLOVDIV, BULGARIA**



**„AUREL VLAICU” UNIVERSITY OF ARAD, FACULTY OF ENGINEERING,  
ARAD, ROMANIA**



**UNIVERSITY OF NIŠ, FACULTY OF MECHANICAL ENGINEERING, NIŠ,  
SERBIA**



**UNIVERSITY OF EAST SARAJEVO, FACULTY OF MECHANICAL  
ENGINEERING EAST SARAJEVO, B&H, REPUBLIC OF SRPSKA**



**UNIVERSITY «St. KLIMENT OHRIDSKI», TECHNICAL FACULTY, BITOLA,  
MACEDONIA**



## **III International Conference - Industrial Engineering and Environmental Protection (IIZS 2013)**

**Organizer of the Conference:**

Technical faculty "Mihajlo Pupin", Zrenjanin, University of Novi Sad, Republic of Serbia

**Reviewers:**

Ph.D James G. Speight, CD&W Inc., Laramie, Wyoming, USA

Ph.D Slawomir Kurpaska, Professor, University of Agriculture in Krakow Institute of Agricultural, Engineering and Informatics

Ph.D Dragiša Tolmač, Professor, Technical faculty "Mihajlo Pupin", Zrenjanin, Republic of Serbia

Ph.D Miroslav Lambić, Professor, Technical faculty "Mihajlo Pupin", Zrenjanin, Republic of Serbia

**Publisher:**

Technical faculty "Mihajlo Pupin", Zrenjanin, University of Novi Sad

**For publisher:**

Ph.D Milan Pavlović, Dean of Technical faculty "Mihajlo Pupin", Zrenjanin

**Technical treatment:**

Ph.D Eleonora Desnica, Technical faculty "Mihajlo Pupin", Zrenjanin, Republic of Serbia

Ph.D Ljiljana Radovanović, Technical faculty "Mihajlo Pupin", Zrenjanin, Republic of Serbia

MSc. Jasmina Pekez, Technical faculty "Mihajlo Pupin", Zrenjanin, Republic of Serbia

**Design:**

MSc. Stanislava Sindelić, Technical faculty "Mihajlo Pupin", Zrenjanin, Republic of Serbia

**Lecturer:**

MSc. Dragica Ivin, Technical faculty "Mihajlo Pupin", Zrenjanin, Republic of Serbia

**Printed by:** Printig office »Diginet«, Zrenjanin

Circulation: 100

ISBN: 978-86-7672-208-2

CIP – Каталогизacija u publikaciji  
Библиотека Матице српске, Нови Сад

62:005.3 (082)

502/504 (082)

INTERNATIONAL Conference Industrial Engineering and Environmental Protection (3; 2013; Zrenjanin)  
Proceedings / III International Conference Industrial Engineering and Environmental Protection (IIZS 2013), Zrenjanin, 30<sup>th</sup> October 2013; [organizer] Technical faculty "Mihajlo Pupin", Zrenjanin . – Zrenjanin: Technical faculty "Mihajlo Pupin", 2013 (Zrenjanin: Diginet) – 463 str. : ilustr.; 30 cm.

Tiraž 100. – Str. 6: Introduction/ Dragiša Tolmač. - Bibliografija.

ISBN 978-86-7672-208-2

а) Индустрijско инжењерство – Зборници б) Животна средина – Заштита – Зборници

COBISS. SR-ID 281195527

### **Scientific Committee:**

**Ph.D Dragiša Tolmač, President, Technical Faculty "Mihajlo Pupin", Zrenjanin, Serbia**

Ph.D James G. Speight, CD&W Inc., Laramie, Wyoming, USA

Ph.D Slawomir Kurpaska, Faculty of Agriculture Engineering, University of Agriculture, Krakow, Poland

Ph.D Miroslav Lambić, Technical Faculty "Mihajlo Pupin", Zrenjanin, Serbia

Ph.D Uroš Karadžić, Faculty of Mechanical Engineering, Podgorica, Montenegro

Ph.D Dimitar G. Petrov, Technical University Sofia, branch Plovdiv, Bulgaria

Ph.D Živoslav Adamović, Technical Faculty "Mihajlo Pupin", Zrenjanin, Serbia

Ph. D Yoncho Pelovsky, University of chemical Technology and Metalurgy, Educational centers, Center of ecology, Sofia, Bulgaria

Ph.D Valentina Emilia Balas, „Aurel Vlaicu” University of Arad, Faculty of Engineering, Arad, Romania

Ph.D Mirko Soković, Faculty of Mechanical Engineering, Ljubljana, Slovenia

Ph.D Mitko Mitkovski, Technical University Sofia, branch Plovdiv, Bulgaria

Ph.D Slavica Prvulović, Technical Faculty "Mihajlo Pupin", Zrenjanin, Serbia

Ph.D Vincenc Butala, University of Ljubljana, Slovenia

Ph.D Slobodan Stojadinović, Technical Faculty "Mihajlo Pupin", Zrenjanin, Serbia

Ph.D Zoran Markov, Faculty of Mechanical Engineering, Skopje, Macedonia

Ph.D Nicolae Farbas, National R & D Institute of Welding and Material Testing, Romania

Ph.D Bojan Podgornik, Faculty of Mechanical Engineering, University of Ljubljana, Slovenia

Ph.D Ljubica Diković, High business technical school of Užice, Serbia

Ph.D Zlatko Lacković, Faculty of Civil Engineering, Osijek, Croatia

Ph.D Eleonora Desnica, Technical Faculty "Mihajlo Pupin", Zrenjanin, Serbia

Ph. D Ljiljana Radovanović, Technical Faculty "Mihajlo Pupin", Zrenjanin, Serbia

Ph.D Miroslav Stanojević, Faculty of Mechanical Engineering, Belgrade, Serbia

Ph.D Jasmina Radosavljević, Faculty of Occupational Safety, Niš, Serbia

Ph.D Ivo Čala, Polytechnic of Zagreb, Croatia

Ph.D Mladen Stojiljković, Faculty of Mechanical Engineering, Niš, Serbia

Ph.D Miodrag Stojiljković, Faculty of Mechanical Engineering, Niš, Serbia

Ph.D Radmila Stikić, Faculty of Agriculture, Zemun, Serbia

Ph.D Snežana Dragičević, Technical Faculty, Čačak, Serbia

Ph. D Ivona Radović, Faculty of Technology and Metallurgy, Belgrade, Serbia

Ph.D Aleksandar Petrović, Faculty of Mechanical Engineering, Belgrade, Serbia

Ph.D Radivoj Topić, Faculty of Mechanical Engineering, Belgrade, Serbia

Ph.D Vlastimir Nikolić, Faculty of Mechanical Engineering, Niš, Serbia

Ph.D Dragoljub Živković, Faculty of Mechanical Engineering, Niš, Serbia

Ph.D Peđa Milosavljević, Faculty of Mechanical Engineering, Niš, Serbia

MSc. Jasmina Pekez, Technical Faculty "Mihajlo Pupin", Zrenjanin, Serbia

MSc. Eleonora Brtko, Technical Faculty "Mihajlo Pupin", Zrenjanin, Serbia

MSc. Višnja Ognjenović, Technical Faculty "Mihajlo Pupin", Zrenjanin, Serbia

### **Organizing Committee:**

**Ph.D Dragiša Tolmač, Technical faculty "Mihajlo Pupin", Zrenjanin, President**

Ph.D Živoslav Adamović, Technical faculty "Mihajlo Pupin", Zrenjanin

Ph.D Miroslav Lambić, Technical faculty "Mihajlo Pupin", Zrenjanin

Ph.D Slobodan Stojadinović, Technical faculty "Mihajlo Pupin", Zrenjanin

Ph.D Slavica Prvulović, Technical faculty "Mihajlo Pupin", Zrenjanin

Ph.D Eleonora Desnica, Technical faculty "Mihajlo Pupin", Zrenjanin

Ph.D Ljiljana Radovanović, Technical faculty "Mihajlo Pupin", Zrenjanin

MSc. Jasmina Pekez, Technical faculty "Mihajlo Pupin", Zrenjanin

MSc. Eleonora Brtko, Technical Faculty "Mihajlo Pupin", Zrenjanin

MSc. Višnja Ognjenović, Technical Faculty "Mihajlo Pupin", Zrenjanin

## **Word of Thanks**

We wish to thank Ministry of Education, Science and Technological Development, Republic of Serbia, for donated financial means which supported printing the Conference Proceedings and organization of III International Conference - Industrial Engineering and Environmental Protection (IIZS 2013).

# INTRODUCTION

---

Departments of Mechanical engineering and General Technical Sciences, at Technical Faculty "Mihajlo Pupin", Zrenjanin, organized three international conferences:

1. »PTEP 2011 - Process Technology and Environmental Protection»,
2. «IIZS 2012 - Industrial Engineering and Environmental Protection»,
3. «IIZS 2013 - Industrial Engineering and Environmental Protection».

Industrial engineering is a field of technique, which includes the processes and procedures, plants, machinery and equipment used in manufacturing final products in different industries. The task of industrial engineers is that on the basis of theoretical and practical knowledge, solve specific problems in engineering practice, and the development of technology in the field of industrial production process.

The theme of scientific conference «IIZS 2013», covers the fields of industrial engineering, which are defined in the program of the conference, such as: Process technology, Engineering, Environmental protection, Health and safety, Manufacturing technology and materials, Machinery maintenance, Design and maintenance of process plants, Basic operations, Machines and processes, Information technology and engineering education, Biotechnology, Reengineering and project management.

The main goals of the conference can be indentified here: innovation and expansion of knowledge engineers in industry and environmental protection; support to researchers in presenting the actual results of research projects, establishing new contacts with leading national and international institutions and universities; popularization of the faculty and its leading role in our society and the immediate environment, in order to attract quality young population for studing at our faculty, cooperation with other organizations, public companies and industry; initiative for collecting ideas in solving specific practical problems; interconnection and business contacts; introducing professional and business organizations with results of scientific and technical research; presentation of scientific knowledge and exchange of experiences in the field of industrial engineering.

We express gratitude to:

- The pratners of the conference – University of agriculture, Faculty of agricultural engineering, Krakow, Poland; Technical university-Sofia, Plovdiv branch, Faculty of mechanical engineering, Plovdiv, Bulgaria; „Aurel Vlaicu” University of Arad, Faculty of engineering, Arad, Romania; University of Niš, Faculty of mechanical engineering, Niš, Serbia; University of East Sarajevo, Faculty of mechanical engineering East Sarajevo, B&H, Republic of Srpska; University «St. Kliment Ohridski», Technical faculty, Bitola, Macedonia,
- Ministry of Education, Science and Technological Development of the Republic of Serbia,
- Zrenjanin Town Hall,
- Regional Chamber of Commerce,
- The management of Technical Faculty «Mihajlo Pupin», University of Novi Sad,

for supporting the organization of the conference «IIZS 2013». We are also grateful to all the authors who have contributed with their works to the organization of the scientific meeting «IIZS 2013».

We would like our Conference to become a traditional meeting of researchers, every year. We are open and thankful for all useful suggestions which could contribute that the next, International Conference - Industrial Engineering and Environmental Protection (IIZS 2014), become better in organizational and program sense.

President of the Organizing Committee  
Prof. Ph.D Dragiša Tolmač

Zrenjanin, 30<sup>th</sup> October 2013.

**Conference participants are from the following countries:**



Serbia



Canada



Slovakia



Thailand



United States of America



Bulgaria



France



Libya



Iran



Poland



Romania



Bosnia and Herzegovina



Italy



FYR Macedonia



Croatia



Montenegro



## CONTENTS

<b>SESSION 1: Process Technology.....</b>	<b>13</b>
HEAT PROBLEMS WITH THE COOPERATION OF HEAT PUMP WITH HEAT VERTICAL EXCHANGER (Sławomir Kurpaska).....	14
ESTIMATION OF PARAMETERS IN A BIOTECHNOLOGY PROCESS MODEL THROUGH THE EXTENDED KALMAN FILTER (Jordan Badev, Jeko Stoitchev, Ivan Maslinkov).....	19
ANALYSIS OF THE POSSIBILITY OF HEATING TOWN OF ZRENJANIN BIOMASS ENERGY (Dragiša Tolmač, Zlatko Košut, Jasna Tolmač, Slavica Prvulović).....	25
EFFECTS OF SUPERPLASTICIZING AND RETARDING ADMIXTURES ON PROPERTIES OF CONCRETE (Salahaldein Alsadey).....	31
SUSTAINABLE DEVELOPMENT HEAT PUMP (Dragan Škobalj, M. Opsenica).....	37
SUMMARY OF THE USING SOLAR ENERGY ON THE GLOBAL LEVEL AND IN THE REPUBLIC OF SERBIA (Bojana Opačić, Dragan Čočkaló, Jasmina Pekez).....	46
SUSTAINABILITY ANALYSIS OF RECYCLING OF MOTOR VEHICLES IN SERBIA AND OPTIMUM TECHNOLOGY REVIEW (Dragiša Tolmač, Jasna Tolmač, Slavica Prvulović, Milan Pavlović).....	53
ENERGY AND EXERGY METHOD APPLIED ON SYSTEM OF HOT WATER BOILER (Milena Todorović, Dragoljub Živković, Marko Mančić, Pedja Milosavljević, Dragan Pavlović).....	58
TREND GROWTH OF SOLAR THERMAL SYSTEMS - FOR THE PERIOD SINCE 2009. by 2012. YEAR (Miroslav Lambić, Novica Pavlović).....	64
<b>SESSION 2: Engineering Environmental Protection and Safety at Work.....</b>	<b>69</b>
RISK ANALYSIS IN THE REFINING INDUSTRY (James G. Speight, Ljiljana Radovanović).....	70
RISK ASSESSMENT FOR CONSTRUCTION OF BRIDGE ON MOTORWAY (Vangelce Mitrevski, Tale Geramitcioski, Vladimir Mijakovski, Monika Lutovska).....	75
RISK ASSESSMENT AT MOTORWAY TUNNEL CONSTRUCTION (Vladimir Mijakovski, Tale Geramitcioski, Vangelce Mitrevski).....	82
TUNNELS AS AN AIR POLLUTANT ON DEMIR KAPIJA – SMOKVICA MOTORWAY CONSTRUCTION (Tale Geramitchioski, Vangelche Mitrevski, Vladimir Mijakovski).....	88
CALCULATION OF THE SHAFT SAFETY FACTOR USING STANDARD DIN 743 AND KISSsoft SOFTWARE (Aleksija Đurić, Biljana Maraković).....	94
<b>SESSION 3: Manufacturing Technologies and Materials.....</b>	<b>101</b>
REFLECTOR WITH MULTILAYER STRUCTURE (Petar Shindov, Dimitar Petrov, Atanas Rusev).....	102
THE ANALYSIS OF THE RESULTS OF DEVELOPMENT AND PRODUCTION OF COATED ELECTRODES WITH A CORE OF FLUX-CORED WIRES (Nikola Bajić, Mihajlo Mrdak, Slobodan Stojadinović, Jasmina Pekez, Karastojković Zoran, Marko Rakin, Darko Veljić).....	106
PROPERTIES OF A SLIDING BEARING MADE OF MULTI-LAYER MATERIALS PRODUCED USING EXPLOSION ENERGY (Rade Katana, Nikola Bajić, Slobodan Stojadinović, Jasmina Pekez).....	109
INVESTIGATION OF THE INFLUENCE OF THE LEVEL OF CARBON AND NITROGEN POTENTIAL AT HIGH TEMPERATURE CARBONITRIDING OF Mn-Cr STEEL (Željko Rosandić, Dejan Anđelković, Ivan Opačak, Vlatko Marušić).....	115

INTEGRITY ASSESSMENT OF WELDED CASING PIPES IN OIL WELL MADE OF API J55 STEEL BY HIGH FREQUENCY WELDING (Ljubica Lazić Vulićević, Živče Šarkoćević, Miodrag Arsić, Aleksandar Sedmak, Marko Rakin, Zijah Burzić, Bojan Medjo).....	121
MASTERING PRODUCTION OF CORED WIRES FOR REPAIRING OF MACHINE PARTS (Nikola Bajić, Darko Veljić, Marko Rakin, Slobodan Stojadinović, Jasmina Pekez, Mihajlo Mrdak).....	129
EXPLOSIVE METAL HARDENING (Rade Katana, Nikola Bajić, Slobodan Stojadinović, Jasmina Pekez).....	133
<b>SESSION 4: Maintenance.....</b>	<b>139</b>
STRESS ANALYSES OF CONNECTION OF TURNTABLE WITH CHASSIS OF ARTICULATED BUS USING SOFTWARE PACKAGE CATIA AND COMPARATIVE METHODS (Ivana Vasović, Marko Ristić, Mirjana Opačić, Mirko Maksimović).....	140
SOFTWARE SUPPORT FOR THE MANAGEMENT OF LUBRICATION (Vlado Krunić, Aleksandar Ašonja, Momčilo Krunić).....	146
MAINTENANCE SYSTEMS OF ALTERNATIVE ENERGY SOURCES (Miodrag Bulatović).....	152
APPLICATION OF THERMOGRAPHY IN MAINTENANCE SYSTEM (Slavica Prvulović, Ljubiša Josimović, Dragiša Tolmač, Rade Hrnjak).....	158
PYROLYSIS FURNACE TUBE DAMAGING AND INSPECTION (Ištvan Kucora, Ljiljana Radovanović).....	162
EXPERT SYSTEMS FOR TECHNICAL DIAGNOSTIC (Rob Decaban, Zoltan Kazi, Ljubica Kazi).....	169
<b>SESSION 5: Design and Maintenance of Process Plants.....</b>	<b>175</b>
DESIGN OF NEW PORTABLE VERTICAL CONE PENETROMETER (Jozef Bajla, Dušan Hrubý).....	176
SUSTAINABLE PROJECTS AS INSTRUMENTS OF SUSTAINABLE DEVELOPMENT (Armin Kovači).....	181
KINEMATICS OF PISTON MECHANISM WITH THE USE ROTATING TRANSFORMATION MATRIX (Danilo Mikić, Eleonora Desnica, Aleksandar Ašonja, Živoslav Adamović).....	187
DYNAMIC UPS SYSTEM (Branislav Todorović, John Olukoyi).....	194
VARIABLE FREQUENCY DRIVE MOTOR CONTROL VIA CANOPEN PROTOCOL IN LABORATORY ENVIRONMENT (Miloš Božić, Srećko Ćurčić, Miloš Trifunović).....	200
PARALLEL FLYING SHEAR (Miloš Božić, Srećko Ćurčić, Vladimir Vitezović).....	206
ELECTRIC CAR (Nikola Nikolić, Nenad Dajić).....	212
<b>SESSION 6: Basic operations, Machinery and Processes.....</b>	<b>219</b>
TRAINING ARTIFICIAL NEURAL NETWORKS FOR DYNAMIC PROCESS MODELLING (Jordan Bađev, Ivan Maslinkov, Jeko Stoitchev, Plamena Madjarova).....	220
MATHEMATICAL MODEL OF A ROLLING STAND (Novica Jevtić, Ljubiša Josimović, Momčilo Bjelica).....	225
NONLINEAR MATHEMATICAL MODEL OF A FLAPER TYPE OF SERVOVALVE (Novica Jevtić, Nebojša Joković, Jelena Danikov).....	230
MATHEMATICAL MODEL OF SERVO-VALVE (Novica Jevtić, Nebojša Joković, Momčilo Bjelica).....	235
NEW TECHNOLOGY DUAL FUEL FOR USE OF LNG AS TRANSPORT FUEL FOR SHIPPING Liquid Natural Gas potential for future transport fuel (Renio Čaleta, Slavica Prvulović, Eleonora Brtko).....	242

ADAPTIVE CONTROL SYSTEM WITH MODEL REFERENCE SYSTEM (AMFC) (Nebojša Joković, Novica Jevtić, Vojin Kerleta, Ljubiša Josimović).....	251
WATER METERS (Nikola Nikolić, Nenad Dajić).....	256
<b>SESSION 7: Computer Technologies and Engineering Education.....</b>	<b>263</b>
CAD 3D MODELING OF SPUR GEAR WHEELS WITH LINEAR CHANGE OF THEIR PROFILE SHIFT COEFFICIENT ALONG THE TOOTH'S LENGTH (Dimitar Petrov, Dimitar Dimitrov).....	264
APPLICATIONS OF THE ADDITIVE MANUFACTURING TECHNOLOGY TO MANUFACTURE THE HIP IMPLANTS (Aleksandar Rajić, Slobodan Stojadinović, Dorian Nedelcu, Eleonora Desnica, Ljubica Lazić Vuličević).....	270
PROJECT OF MECHANICAL SYSTEMS DESIGN (Thibault LE GALL).....	279
USE OF CAD APPLICATION IN THE EDUCATION OF COMPUTER ERGONOMICS (Biljana Gemović, Nataša Subić, Tanja Krunić).....	284
E-LEARNING STANDARDS AN OVERVIEW (Eleonora Brtka, Višnja Ognjenović).....	290
SEARCH ALGORITHMS IN TRAVEL ROUTE PLANNING (Višnja Ognjenović, Eleonora Brtka).....	295
APPLICATION OF WIRELESS SENSOR NETWORKS IN INDUSTRIAL SYSTEMS (Dalibor Dobrilović, Vladimir Šinik).....	300
<b>SESSION 8: Biotechnology.....</b>	<b>307</b>
USE OF BIOMASS AS A RENEWABLE ENERGY SOURCE IN SERBIA (Emina Mihajlović, Jasmina Radosavljević, Miomir Raos, Ljiljana Živković, Nenad Živković).....	308
ANALYSIS OF CHEMICAL AND THERMAL QUALITY INDICATORS OF BIOMASS ENERGY PELLETS (Zorica Gluvakov, Miladin Brkić).....	314
BIOMASS AND SUSTAINABLE DEVELOPMENT (Srđan Vasković, Vlado Medaković, Davorin Đurović).....	321
<b>SESSION 9: Reengineering and Project Management.....</b>	<b>327</b>
LINGUISTIC PROJECT MANAGER SELECTION (Ali Reza Afshari, Ahmad Baghi).....	328
THE USE OF STATISTICAL METHODS TO ANALYSIS EXPORTS OF LIBYAN IRON AND STEEL COMPANY (Ramadan Ahmed Abuggeddida).....	334
VIRTUAL ENVIRONMENT IN POLISH TOURISM ENTERPRISES: NOW AND IN THE FUTURE (Ewa Forystek-Zabojszcz, Jolanta Staszewska).....	340
REGIONAL DEVELOPMENT AGENCY FOR SMEs AS A FACTOR OF ECONOMIC DEVELOPMENT OF LOCAL COMMUNITIES (Vlado Medaković, Slaviša Moljević, Srđan Vasković).....	347
KNOWLEDGE MANAGEMENT AND DEVELOPMENT PERSPECTIVES OF COMPETITIVENESS OF SERBIAN COMPANIES (Đuro Kovačević, Cariša Bešić, Radomir Stanišić, Snežana Bešić).....	353
IMPROVEMENT FACTORS OF COMPETITIVENESS OF DOMESTIC COMPANIES (Snežana Bešić, Đuro Kovačević, Cariša Bešić).....	358
<b>SESSION 10: Process Management and Energy Efficiency.....</b>	<b>363</b>
APPLICATION OF SENSITIVITY ANALYSIS IN PRE-MEASUREMENT PHASE OF BUILDING ENERGY MODEL CALIBRATION (Marko Ignjatović, Bratislav Blagojević, Branislav Stojanović).....	364
ENERGY INTEGRATION OF NITRIC ACID SYNTHESIS PROCESS USING HINT (Sofija Miškov, Gorica Ivaniš, Marija Lazarević, Ivona Radović, Mirjana Kijevčanin).....	370

PROJECT PREPARATION ISSUES FOR ERP IMPLEMENTATION IN VERTICALLY INTEGRATED OIL COMPANIES (Aleksandar Stojkov, Eleonora Brtko).....	376
MANAGEMENT FOR CONTROL OF PROTECTION IN WORKING UNIT MINE BOGUTOVO SELO-UGLJEVIK (Bojan Tešić, Miodir Stanković).....	383
COMPARISON OF PERFORMANCES OF MICRO HYBRID TRIGENERATION SYSTEMS FOR ENERGY DEMANDS OF A SMALL RESIDENTIAL BUILDING (Marko Mančić, Dragoljub Živković, Milan Đorđević, Milena Todorović, Saša Pavlović).....	388
THE IMPACT OF CLOUD COMPUTING IMPLEMENTATION ON A COMPANY'S ECO POLICY (Vladimir Čolić, Savina Čolić, Višnja Ognjenović).....	394
SOURCES OF FUNDING FOR PROJECTS IN THE FIELD OF ENERGY EFFICIENCY AND RENEWABLE ENERGY SOURCES (Dragan Pavlović, Milena Todorović, Peđa Milosavljević).....	399
TEMPERATURE CHARACTERISTICS OF MASSIVE SOLAR WALLS (Miroslav Lambić, Novica Pavlović).....	404
IMPROVING PERFORMANCE IN THE POWER OF DRIVE WITH ELECTROMAGNETIC VIBRATORY FEEDER (Željko Despotović, Vladimir Šinik).....	407
<b>SESSION 11: Student papers.....</b>	<b>415</b>
THE IMPORTANCE OF INTELLIGENT TRANSPORTATION SYSTEMS IN TRAFFIC (Svetlana Dobrosavljev, Slavica Prvulović).....	416
CONTRIBUTION TO THE DEVELOPMENT OF PLANTS FOR BRIQUETTE BIOMASS (Jasna Tolmač, Dragiša Tolmač).....	420
IMPROVED ACTIVE SOLAR COLLECTOR (Jonaš Darjan, Đurđev Mića).....	424
APPLICATION OF POLYMER PACKAGING IN INDUSTRIAL DESIGN (Viktorija Verebeš, Eleonora Desnica).....	430
CITIZENS' AWARENESS ON GEOTHERMAL ENERGY IN THE TOWN OF ZRENJANIN (Mila Zakin, Ljiljana Radovanović).....	435
PRODUCTION OF A PIG IRON IN A BLAST FURNACE, STEEL IN THE CONVERTER AND THEIR FURTHER PROCESSING BASED ON THE Fe-Fe <sub>3</sub> C DIAGRAM (Branka Simić, Slobodan Stojadinović).....	442
PNEUMATICS PRODUCTION AND RECYCLING (Dušan Kojčić, Eleonora Desnica).....	449
RESEARCH SATISFACTION POPULATION SUSTAINABLE CITIES ZRENJANIN (Ivana Petkanić, Ljiljana Litričin, Mila Zakin, Živoslav Adamović).....	454
PROBABILITY OF OCCURRENCE OF MALFUNCTION (Ivan Palinkaš, Danijela Vojnović, Biljana Goševski).....	462
AUTOMATIC DIAGNOSTIC CONTROL OF THE CONDITION OF THE SYSTEM (Ivan Palinkaš, Vojin Kerleta).....	467

## **SESSION 1: Process Technology**

## HEAT PROBLEMS WITH THE COOPERATION OF HEAT PUMP WITH HEAT VERTICAL EXCHANGER

**Slawomir Kurpaska**

Faculty of Power Engineering and Energetic at University of Agriculture in Cracow, Poland

e-mail: [rtkurpas@cyf-kr.edu.pl](mailto:rtkurpas@cyf-kr.edu.pl)

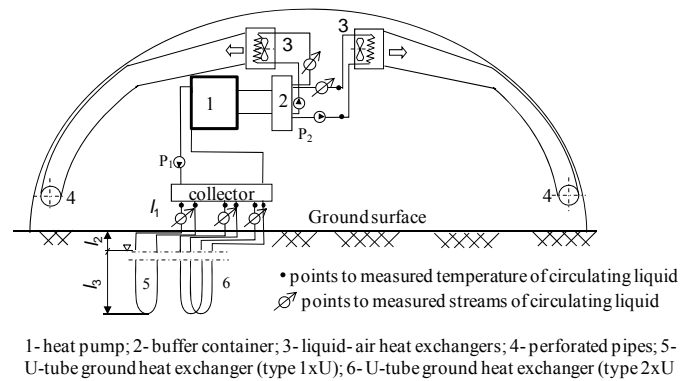
**Abstract:** Legal regulations, development of technology of producing devices for obtaining energy from renewable sources, increase of their efficiency, duration, resistance to climatic conditions causes that traditional devices for obtaining energy may be substituted to a higher extent by other devices, including a heat pump. It is known that efficiency to transfer heat from the so-called lower source (ground, water, air), besides investment costs, electric energy costs, decides on the profitability of its use. The issue concerning the analysis of heat exchange in this system element was the subject of the research which was carried out in many scientific centres.  
**Key words:** heat pump, heat vertical exchanger

### INTRODUCTION

Hua et al. [2013] presented a mathematical model of the heat transfer in the ground (exchangers located at the maximum depth of 100 m were considered), where the following were accepted as decisive variables: thermal and physical properties of the ground and a conduit of which plumbs were made, distances between exchangers and their depths, flow speeds of the circulation factor. Schiffmann and Favrat [2010] developed a programme for optimization of the compressor heat pump operation along with the factor flow analysis. The results obtained by theoretical research were verified by them on a measurement stand with a multi-stage compressor, where throttling and compressing processes occur. It was concluded that the applied method may be used in the procedure of parameters optimization of the compressor pump impeller, minimization of losses related to the transformation of the thermodynamic factor and at rational control of its operation. Omer [2008] presented constructive solutions of the ground exchangers cooperating with compressor heat pumps. Benli [2013] analysed the use of the heat pump for heating an experimental greenhouse. Ground exchangers (both horizontal as well as vertical) constituted a lower source. Sanaye and Niroomand [2011] analysed energy effects and carried out the procedure of optimization of economic indexes for stream heat pump cooperating with ground exchangers. Hwang et al. [2009] investigated the effects of using the heat pump cooperating with vertical heat exchangers used for heating a school determining the efficiency of work in the cooling cycle. The authors also compared the obtained effects with a heat pump, where air was used as a lower heat source. Tong et al. [2010] analysed energy effects of a heat pump with a lower source in the form of an exchanger of liquid-air type used for heating an experimental greenhouse. Leong et al. [1998] carried out simulation experiments in which they analysed operation efficiency of a heat pump cooperating with horizontal ground heat exchangers. Three different soils (sand, sandy clay and loamy clay) of varied humidity were assumed as input variables. It was found that the highest energy efficiency was obtained for sandy soil, moreover for all types of ground, relation of the researched parameter to its moisture was reported. Kurpaska [2008] developed a nomogram for determination of structural and exploitation parameters of mono systems (the pump cooperated with ground exchangers) and bivalent (cooperation of the heat pump with the system of conversion of radiation into hot water) where the heat pump was used for heating a plastic tunnel. Significance of the research issue explicitly appears from the quoted literature review, as a consequence of which, the obtained results serve for improving the work efficiency of the heat pump.

### MATERIAL AND METHODS

The system presented schematically in fig.1 is the subject of analysis.



**Figure 1.** Scheme of laboratory stand

As it appears from the above, a part of the heat exchanger constitutes a horizontal segment (with length of  $l_1$ ), whereas the part is located in the ground with or without the contact with the ground water (respectively length of the the segment  $l_2$  i  $l_3$ ). Total depth of the vertical borehole is 100 m.

The heat transport in the closest surrounding of the ground heat exchanger that is in the ground is an issue which is described as a function of space and time coordinates. It is also a problem linked to the liquid flow. The linking consists in the heat transport by means of convection from liquid to the wall of U-pipe and then by means of conduct through its wall to the ground. A three-dimensional model of heat exchange in ground (along with initial-border conditions) completed with equations describing the issue of movement and continuity of liquid flow and the heat exchange for the flow of circuit liquid should be applied for full theoretical description of thermal issues.

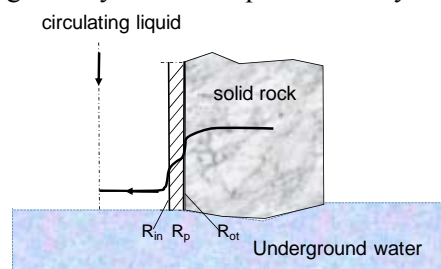
One of approach allowing determination of exchanger efficiency ( $q_t'$ ) is determination of thermal resistance and then using the relation in the following form [Zalewski, 2001]:

$$q_t' = \frac{T_{gr} - T_l}{R_t} \quad (1)$$

where:  $T_{gr}$ - ground temperature in the profile undisturbed with pump activity, °C,  $T_l$ - circulation factor temperature, °C;  $R_t$ - total linear thermal resistance, mK/W.

A calculated final of thermal efficiency of the exchanger was determined as a weighted average from particular segments featuring variable efficiency.

In fig. 2 Scheme of conduit along with symbols accepted for analysis.



**Figure 2.** Scheme of the considered element along with the accepted symbols

Determination of the resistance of heat movement on the way: liquid-surrounding environment is an indispensable parameter occurring in the considered issue. Therefore, it may be written down as follows:

$$R_t = R_{in} + R_p + R_{ot} \quad (2)$$

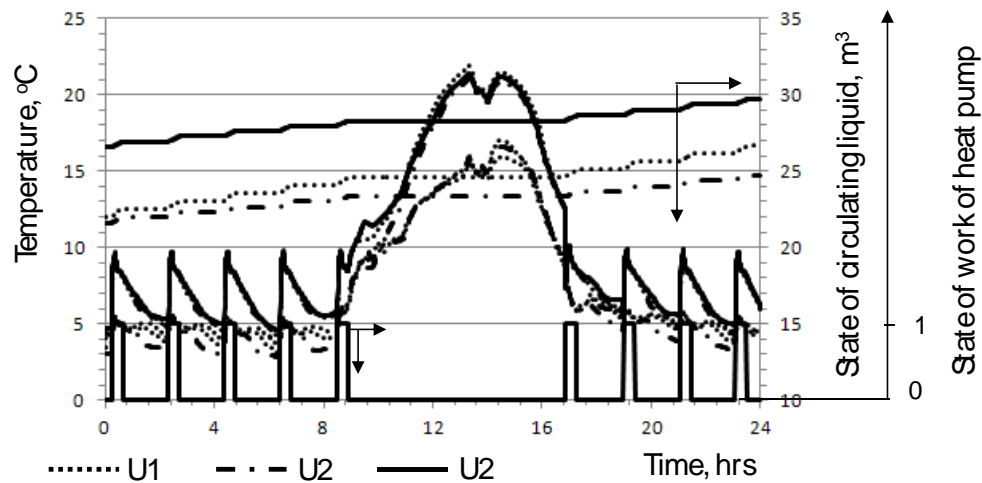
Verification research was carried out on the stand (fig.1) and based on the measured sizes (stream, temperature difference) linear thermal efficiency of the plumb was measured as:

$$q_m' = \frac{m_{PC} c_l \Delta T}{l_p} \quad (3)$$

where:  $m_{PC}$ - stream of the flowing factor in a given cycle, kg/s;  $c_l$ - specific heat of the circulation factor, J/kgK,  $l_p$ -total length of the exchanger, m.

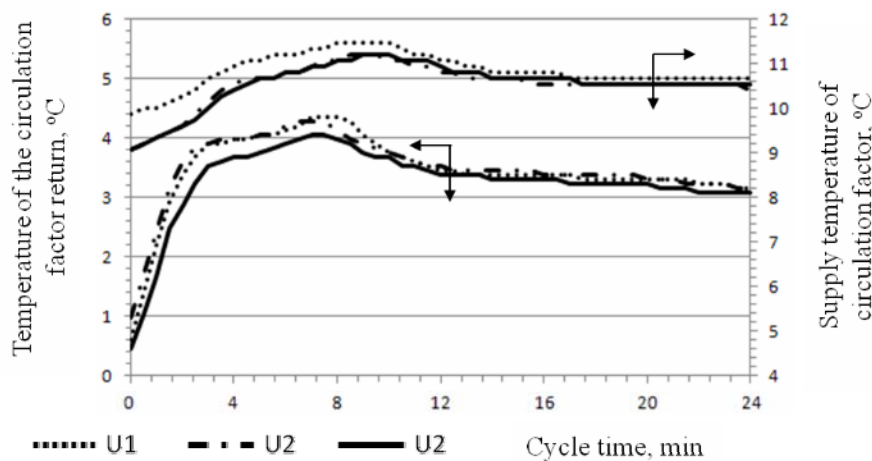
## RESULTS AND DISCUSSION

The tests were carried out in March (2013) when acc. to long-standing average temperature at the depth of 0.5 was 3°C. Fig. 3 presents the course of measured parameters for one of the daily performance cycle of the heat pump.



**Figure 3.** Daily course of the measured parameters during the heat pump performance

One may notice that during the considered operation time there were 9 cycles of the heating pump operation. The length of the cycle was within the range of 22.5 to 24 minutes. During this time, average volume of the factor, which was pressed through vertical exchangers in particular cycles of the pump operation was: type U1 0.34 whereas for the exchanger type U2 it was 0.51 and 0.34m<sup>3</sup>. While, during the heating pump performance, average difference between the supply temperature and the return of the circulation factor in particular cycles was for the exchanger: U1 from 2.3 to 3.5 whereas for exchanger type U2 for particular U-pipes from 2.38 to 3.8 K and from 2.1. to 3.5K. Fig. 4 presents the course of temperatures for one of 9 performance cycles of the heat pump.



**Figure 4.** Course of supply temperature changes and return of the circulation factor of the selected operation cycle of the heat pump

As one may notice, only after approx. 20 minutes of the heat pump operation stabilization of temperature changes occurred in the analysed ground exchangers. Similar regularities were reported for the remaining operation cycles of the heat pump. Therefore, it may be assumed that during this time, a determined process of heat exchange between liquid in the exchanger and the surrounding ground occurred. Thus, a detailed analysis related to heat capacity of vertical ground heat exchangers was carried out for the established process.



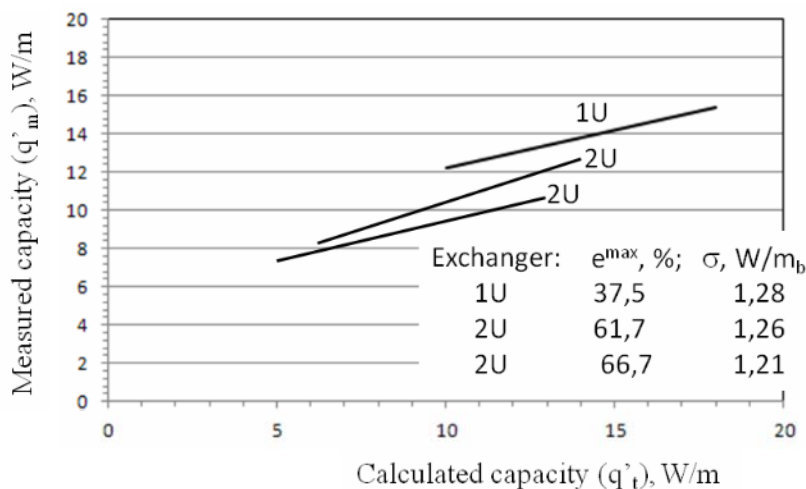
Table 1 presents enumerated values of unitary resistance and temperature of the wall for one exemplary cycle, in which temperature of pressing the circulation factor for the established process was 5 and the return was 8°C. Temperature of the wall was calculated by means of standard relations describing the heat movement by a ring partition.

**Table 1.** Enumerated values of unitary resistance

Specification	Thermal resistance, mK/W		
	R <sub>in</sub>	R <sub>p</sub>	R <sub>ot</sub>
Vertical exchanger (to the level of ground waters)	0.29	0.059	0.33
Ground exchanger (in ground water)	0.29	0.059	0.16

Linear capacity of the ground exchanger was carried out based on 50 performance cycles of the heat pump. From the analysis which was carried out, it appears that unit thermal efficiency of the considered exchangers is, for the exchanger type 1U -14.1 whereas for total efficiency for the exchanger type 2U 19.2 1W/running m<sub>of the conduit</sub>. When comparing the unit capacity of the analysed exchangers one may say that total thermal efficiency of the exchanger type 2U is approx. 36% higher than exchanger type 1U in the researched operation cycles.

Fig. 5 presents results of the comparison of efficiency determined from the presented relation ( $q'_t$ ) and measurements ( $q'_m$ ) for the analysed ground exchangers.



**Figure 5.** Comparison between calculated and measured unit efficiency of ground exchangers

Additionally, a calculated value of the relative error-  $e^{\max}$  (calculated towards the measured value) and the value of the mean square error ( $\sigma$ ) was marked.

As can be seen, the comparison is characterised by satisfying conformity whereas correlation coefficient ( $r$ ) is within 0.78 to 0.81.

If one assumes that the ground exchanger was located directly at the place of locating the heat pump, then thermal capacity of the boreholes will be from 41.5 (exchanger type 1U) to 56.6W/running m<sub>of borehole</sub> for the exchanger type 2U.

## CONCLUSIONS

1. Total thermal resistance of the analysed ground plumbs, depending on their geometrical location is within 0.51 to 1.02 mK/W.
2. Comparison between the measured and calculated unit efficiency of the exchanger conduit is characterized by conformity at the level: correlation coefficient (0.78 to 0.81), a range of the maximum relative error is within 37.5 to 66.7% whereas the range of mean square error is changing from 1.21 to 1.28 W/running  $m_{\text{of the conduit}}$ .
3. Mean unit thermal efficiency of the considered exchangers is, for the exchanger type 1U - 14.1 whereas for total efficiency for the exchanger type 2U 19.2 1W/running  $m_{\text{of the conduit}}$ .
4. In case of locating the heat pump directly next to the boreholes, then average thermal efficiency of the borehole where the exchanger type 1U is located is 41.5W whereas a borehole with the installed exchanger type 2U equals 56.6 W/running  $m_{\text{of borehole}}$ .

## REFERENCES

- [1] Benli H. (2013). A performance comparison between a horizontal source and a vertical source heat pump systems for a greenhouse heating in the mild climate Elazig, Turkey. *Applied Thermal Engineering* 50, 197 -206
- [2] Hua P. Yub Z., Zhua N., Leia F., Yuan X. Performance study of a ground heat exchanger based on the multipole theory heat transfer model. *Energy and Buildings* 65 (2013) 231–241
- [3] Hwang Y., Lee J.K, Jeong Y.M., Koo K.M., Lee D.H, Kim I.K., Jin S.W. Kim S.H. (2009). Cooling performance of a vertical ground-coupled heat pump system installed in a school building, *Renewable Energy* 34 (3), 578- 582.
- [4] Kurpaska S. (2008). Wytyczne konstrukcyjno-eksploatacyjne dla systemów wykorzystujących pompę ciepła do ogrzewania obiektów ogrodnich. *Inżynieria Rolnicza*. Nr 2 (100). s. 155-162
- [5] Li Z., Zheng M. (2009). Development of a numerical model for the simulation of vertical U-tube ground heat exchangers. *Applied Thermal Engineering*, 29, 920–924.
- [6] Leong W. H., Tarnawski V. R. Aittomaki A. (1998). Effect of soil type and moisture content on ground heat pump performance. *International Journal Refrigeration*, 21(8),595- 606
- [7] Omer M.A. (2008). Ground-source heat pumps systems and applications. *Renewable and Sustainable Energy Reviews* 12 (2008) 344–371
- [8] Sanaye S., Niroomand B. (2011). Vertical ground coupled steam ejector heat pump; thermal-economic modeling and optimization. *International Journal of refrigeration* 34, 1562- 1576
- [9] Schiffmann J., Favrat D. (2010). Design, experimental investigation and multi-objective optimization of a small-scale radial compressor for heat pump applications *Energy* 35, 436–450
- [10] Tong Y., Kozai T., Nishioka N., Ohya K. (2010). Greenhouse heating using heat pumps with a high coefficient of performance (COP), *Biosystem Engineering* 106, 405- 411.
- [11] Zalewski W. *Pompy ciepła: sprężarkowe, sorpcyjne i termoelektryczne* (in Polish). Wydawnictwo IPPU Masta, Gdańsk, 2001.

## ESTIMATION OF PARAMETERS IN A BIOTECHNOLOGY PROCESS MODEL THROUGH THE EXTENDED KALMAN FILTER

**Jordan Badev, Jeko Stoitchev, Ivan Maslinkov**

University of Food Technologies, Technical Faculty, Plovdiv, Bulgaria

e-mail: [j\\_badev@abv.bg](mailto:j_badev@abv.bg)

**Abstract:** In this writing we suggest the application of the Kalman filter for identification of a periodic biotechnology process with processing values hard to measure. As an example for the appropriateness of the obtained results and suggested solutions a periodic process of the acetic acid fermentation has been employed.

**Keywords:** Extended Kalman filter, modelling, control, optimization, biotechnology process, kinetics, acetic acid fermentation

### INTRODUCTION

In the last half century at home and abroad, the various aspects of biotechnology processes (BTP) have been intensively explored. In general, it is worth noting the spheres of: improvement and intensification of BTP and the pertaining preparatory and closing operations; expansion of the BTP applications connected to human health, living standard and ecology; selection of highly productive producers; perfection of the processing equipment; control, optimization and intensification of BTP.

Any biotechnology production requires good and often high level of automation of the production processes. To generate an efficient and requirements fitting automated control system it is necessary to have precise knowledge of the particular BTP in terms of its control, i.e. as an object of automation.

It is a fact [7] that BTP are complex, non-linear, non-stationary objects of incomplete data whose static and dynamic characteristics vary in a wide range. They are based on the life cycle of numerous micro-organisms and differ in quality terms from the non-living nature processes.

### MATERIAL AND METHODS

#### Models describing the BTP kinetics

The task of effective control, and as a following stage relating to the BTP optimisation, requires comparison between a significant number of realisation options. Their approbation in industrial, pilot or laboratory installations imposes many predicaments, and quite often turns impossible. That is why the actual process is sought to be substituted by an analogy in the form of a mathematical model [8]. Therefore, a major stage in researching BTP as a control object is the drafting of a mathematical model describing the process kinematics.

In modelling the kinematics of the fermenting processes there are two approaches leading to two types of description – structural and non-structural models. The latter, due their formal nature, describing of process on the macro levels using values directly measurable, are most often applied for the control and optimisation of the various microbiological processes.

The principal approach in this structuring is based on the material balance of variables characterising BTP: concentration of biomass  $X$ , substrate  $S$ , and product  $P$  and other, affecting the speed rate of macro reactions. For a periodical process in the frequent case of single substrate and single product, the differential equations system is of the type:

$$\left\{ \begin{array}{l} \frac{dX}{dt} = \dot{X} = \mu X; \\ \frac{dS}{dt} = \dot{S} = -\frac{\mu}{Y} X; \\ \frac{dP}{dt} = \dot{P} = \frac{\alpha\mu}{Y} X; \\ \mu = \mu_m \frac{S}{K_S + S}, \end{array} \right. \quad (1)$$

where:  $\mu_m$  is the maximum growth rate of micro organisms with no limitation (insufficiency) of substrate;  $K_S$  - limitation constant by  $S$ , equal to the substrate concentration at a specific growth rate

$$\mu = \frac{1}{2} \mu_m.$$

### Estimation of the parameters of model

The solving of (1), i.e. the mathematical description of a periodical fermenting process kinetics is concerned with measuring the concentrations of biomass  $X$ , the substrate  $S$  and the product  $P$  during the process. This is rarely possible to be done, even with one of the three, with automatic devices on line. Often various laboratory methods are applied, presented with a number of obstacles and inaccuracies, objective and subjective errors, etc. That is why the output data is rather “noisy”. A frequent case, not only in industry but also in laboratory conditions is to follow the permutation of one or two variables ( $X$  and  $P$  or  $X$  and  $S$ ) with the required precision, and for the rest – data is collected at the beginning and the end of the process. Since in the entire duration of process physical, chemical and biological permutations occur in the cultural medium the process is considered non-stationary. Such processes are characterised by values, not all of which are easy and precisely measurable, and some of them are of stochastic nature. These, and some other reasons complicate the modelling and efficient (optimal) control. As a basic hypothesis of analytical model of these processes often known models are applied, e.g. (1). Its adapting to the particular process is in specifying the structure and calculating the coefficients in the equations. Under these conditions it is important that the identification method be defined in a stochastic media, be recursive and applicable “on line”, be operational with incomplete set of data on the hard to measure values, i.e. predictability, be described by a discrete models, because of the discrete nature of the experimental data, etc. Therefore, to find a relevant mathematical model of a given BTP it is necessary to use methods for defining the coefficients and solving (1), accounting for the said peculiarities. One of the options is the Kalman filter [1], [9].

**AIM.** Identification of a periodic BTP trough the extended Kalman filter (EKF) applying it for optimal control with hard to measure processing values.

### Estimation of parameters of a periodic BTP model trough the extended Kalman filter.

If we designate:

$$X(t) = x_1(t); S(t) = x_2(t); P(t) = x_3(t) \text{ and } \mu_m = k_1; K_S = k_2; \frac{\mu_m}{Y} = k_3; \frac{\alpha}{Y} \mu_m = k_4$$

substituting in the system (1), it becomes:

$$\left\{ \begin{array}{l} \dot{x}_1(t) = \frac{k_1 x_1(t) x_2(t)}{k_2 + x_2(t)} \\ \dot{x}_2(t) = -\frac{k_3 x_1(t) x_2(t)}{k_2 + x_2(t)}; \\ \dot{x}_3(t) = \frac{k_4 x_1(t) x_2(t)}{k_2 + x_2(t)} \end{array} \right. \quad (2)$$

Obviously the model is non-linear against the state variables  $x_1, x_2, x_3$  and the coefficients  $k_1, k_2, k_3, k_4$  and the Kalman formulations, defined for linear models, are not possible to be applied directly. In order to use Kalman recursion for estimation of the coefficients  $k_1, k_2, k_3, k_4$  in the non-

linear model, the state vector must be first extended by the coefficients and the model be linearised. In this case the obtained estimations are quazi-optimal.

For the extension it is assumed that the coefficients do not vary within the period between two measurement, i.e. for  $k \leq t \leq k+1$ ,  $k_1(t) = const$ ,  $k_2(t) = const$ ,  $k_3(t) = const$ ,  $k_4(t) = const$ .

The state variables in the extended model are introduced by the following pattern:

$$z_1 = x_1; z_2 = x_2; z_3 = x_3; z_4 = k_1; z_5 = k_2; z_6 = k_3; z_7 = k_4,$$

i.e. the expanded state vector is  $z = [x_1, x_2, x_3, k_1, k_2, k_3, k_4] = [z_1, z_2, z_3, z_4, z_5, z_6, z_7]$ .

The expanded uninterrupted state model is given as a system of differential equations of the type:

$$\begin{cases} \dot{z}_1(t) = \frac{z_4(t)z_1(t)z_2(t)}{z_5(t) + z_2(t)} + w_1(t) \\ \dot{z}_2(t) = -\frac{z_6(t)z_1(t)z_2(t)}{z_5(t) + z_2(t)} + w_2(t); \\ \dot{z}_3(t) = \frac{z_7z_1(t)z_2(t)}{z_5 + z_2(t)} + w_3(t); \\ \dot{z}_4(t) = 0 + w_4(t) \\ \dot{z}_5(t) = 0 + w_5(t) \\ \dot{z}_6(t) = 0 + w_6(t) \\ \dot{z}_7(t) = 0 + w_7(t) \end{cases} \quad (3)$$

The discretised variant of the model may be given as:

$$\begin{aligned} z_1(k+1) &= f_1(z(k), w_1(k)) = z_1(k) + \Delta t \left( \frac{z_4(k)z_1(k)z_2(k)}{z_5(k) + z_2(k)} + w_1(k) \right); \\ z_2(k+1) &= f_2(z(k), w_2(k)) = z_2(k) + \Delta t \left( -\frac{z_6(k)z_1(k)z_2(k)}{z_5(k) + z_2(k)} + w_2(k) \right); \\ z_3(k+1) &= f_3(z(k), w_3(k)) = z_3(k) + \Delta t \left( \frac{z_7(k)z_1(k)z_2(k)}{z_5(k) + z_2(k)} + w_3(k) \right); \\ z_4(k+1) &= f_4(z(k), w_4(k)) = z_4(k) + w_4(k); \\ z_5(k+1) &= f_5(z(k), w_5(k)) = z_5(k) + w_5(k); \\ z_6(k+1) &= f_6(z(k), w_6(k)) = z_6(k) + w_6(k); \\ z_7(k+1) &= f_7(z(k), w_7(k)) = z_7(k) + w_7(k); \end{aligned} \quad (4)$$

$$y_1(k) = h_1(z(k), v_1(k)) = z_1(k) + v_1(k);$$

$$y_2(k) = h_2(z(k), v_2(k)) = z_2(k) + v_2(k);$$

$$y_3(k) = h_3(z(k), v_3(k)) = z_3(k) + v_3(k).$$

With  $w_i(k), v_j(k)$  the noise in the object is designated, and they may be viewed as a model error.

Where  $\Delta t$  is discretisation period.

It is obvious that the model is non-linear toward the coordinates of the  $z(k)$  vector and is of the seventh order. If we express this non-linear model through Taylor's series toward the vector's coordinates  $\hat{z}(k) = [\hat{z}_1(k), \hat{z}_2(k), \hat{z}_3(k), \hat{z}_4(k), \hat{z}_5(k), \hat{z}_6(k), \hat{z}_7(k)]$ , and the zero noise sequences ( $w_i(k) = v_j(k) = 0$ , for  $i = 1, 2, \dots, 7; j = 1, 2, 3$ ), and after omitting the higher members [4], [5], we shall obtain the following matrix model:

$$\begin{aligned} z(k+1) &= F(k)z(k) - F(k)\hat{z}(k) + f(k) \\ y(k) &= H(k)z(k) \end{aligned} \quad (5)$$

It is evident that, in model (5) the state vector  $z(k)$  participates in a linear way and the Kalman recursion is applicable.

The vectors and matrices in the model (5) are respectively:

$$z(k+1) = \begin{pmatrix} z_1(k+1) \\ z_2(k+1) \\ \dots \\ z_7(k+1) \end{pmatrix} \quad F(k) = \begin{pmatrix} \left. \frac{\partial f_1}{\partial z_1} \right|_{\#} & \left. \frac{\partial f_1}{\partial z_2} \right|_{\#} & \dots & \left. \frac{\partial f_1}{\partial z_7} \right|_{\#} \\ \left. \frac{\partial f_2}{\partial z_1} \right|_{\#} & \left. \frac{\partial f_2}{\partial z_2} \right|_{\#} & \dots & \left. \frac{\partial f_2}{\partial z_7} \right|_{\#} \\ \dots & \dots & \dots & \dots \\ \left. \frac{\partial f_7}{\partial z_1} \right|_{\#} & \left. \frac{\partial f_7}{\partial z_2} \right|_{\#} & \dots & \left. \frac{\partial f_7}{\partial z_7} \right|_{\#} \end{pmatrix} \quad (6)$$

where with # designated is  $\# = \{ z_i(k) = \hat{z}_i(k), w_i(k) = v_i(k) = 0 \}$ , for  $i = 1, 2, \dots, 7$ .

The particular form of the matrix  $F(k)$  (differential quotient matrix) is:

$$F(k) = \begin{pmatrix} 1 + \Delta t \frac{z_2 z_4}{(z_2 + z_5)} & \Delta t \frac{z_1 z_4 z_5}{(z_2 + z_5)^2} & 0 & \Delta t \frac{z_2 z_4}{z_2 + z_5} & \Delta t \frac{-z_1 z_2 z_4}{(z_2 + z_5)^2} & 0 & 0 \\ -\Delta t \frac{z_2 z_6}{z_2 + z_5} & 1 - \Delta t \frac{z_1 z_5 z_6}{(z_2 + z_5)^2} & 0 & 0 & \Delta t \frac{z_1 z_2 z_6}{(z_2 + z_5)^2} & -\Delta t \frac{z_1 z_2}{z_2 + z_5} & 0 \\ \Delta t \frac{z_2 z_7}{z_2 + z_5} & \Delta t \frac{z_1 z_5 z_7}{(z_2 + z_5)^2} & 1 & 0 & -\Delta t \frac{z_1 z_2 z_7}{(z_2 + z_5)^2} & 0 & \Delta t \frac{z_1 z_2}{z_2 + z_5} \\ 0 & 0 & 0 & 1 & 0 & 0 & 0 \\ 0 & 0 & 0 & 0 & 1 & 0 & 0 \\ 0 & 0 & 0 & 0 & 0 & 1 & 0 \\ 0 & 0 & 0 & 0 & 0 & 0 & 1 \end{pmatrix} \quad (7)$$

The particular form of the non-linear functions  $f(k)$  is:

$$f(k) = \begin{pmatrix} \left. f_1(z) \right|_{\#} \\ \left. f_2(z) \right|_{\#} \\ \dots \\ \left. f_7(z) \right|_{\#} \end{pmatrix} = \begin{pmatrix} z_1(k) + \Delta t \left( \frac{z_4(k) z_1(k) z_2(k)}{z_5(k) + z_2(k)} \right) \\ z_2(k) + \Delta t \left( -\frac{z_6(k) z_1(k) z_2(k)}{z_5(k) + z_2(k)} \right) \\ z_3(k) + \Delta t \left( \frac{z_7(k) z_1(k) z_2(k)}{z_5(k) + z_2(k)} \right) \\ z_4(k) \\ z_5(k) \\ z_6(k) \\ z_7(k) \end{pmatrix}_{\#} \quad (8)$$

The basic members in (5) are the vector of the functions  $f(k)$  and the differential quotient matrix  $F(k)$ , calculated for each  $k$  (each tact) by the already obtained estimations  $\hat{z}(k)$  and zero noises, thus the obtained values are the predicted  $z(k+1/k)$  for the next  $k+1$  tact.

In [5] it is proven that the so linearised models are subject to identifying, which renders certainty in the application of the method.

## RESULTS AND DISCUSSION

For the so linearised discrete model, the Kalman equations (recursion) [5] are applied, for  $k = 1, 2, 3, \dots$

$K(k) = P(k/k-1)H'[H*P(k/k-1)H'+R(k)]^{-1}$	- ESTIMATION of the filter's coefficients
$z(k) = z(k/k-1) + K(k)[y(k) - H*z(k/k-1)]$	- ESTIMATION of the extended vector;
$P(k) = P(k/k-1) + K(k)H*P(k/k-1)$	- ESTIMATION of the error variance matrix;
$z(k+1/k) = f(k)$	- PREDICTION regarding the extended vector;
$P(k+1/k) = F(k)P(k)F'(k) + Q(k)$	- PREDICTION regarding the error variance matrix;
$y(k) = H*z(k)$	- ESTIMATION of output.

In the recursion: the initial values  $z(1/0)$  are assigned maximally close to the actual ones, and are considered predictive; the initial error variance matrix  $P(1/0)$  is assigned as a diagonal of sufficiently large values; the variance matrices  $Q(k)$  and  $R(k)$  in the recursion are calculated in each tact of simulated random signals for  $w(k)$  and  $v(k)$

The presented method for estimation of coefficients in the model of acetic acid fermentation has its software elaboration under MATLAB<sup>®</sup>. As a trial example we have used a periodical process of acetic acid fermentation; the identification data has been obtained in a laboratory, following a schedule maximally close to the industrial conditions [3], [6].

In Fig. 1 illustrated are, for  $X$ , the interpolated experimental data (exp.), the filter obtained estimation for this quantity (est.) and the filter prediction (pred.) outstripping a tact.

In Fig. 2 and 3 respectively, illustrated for  $S$  and  $P$  are the experimental data, the estimation and the prediction. The production process duration of the acetic acid fermentation, studied in laboratory conditions, is approximately 22 hours. The charts show clearly a fair approximation of the experimental, assessed and predicted values of the three major in this technology quantities. It is further observed that yet at the beginning of the process, substantial deviations are present: for  $X$  – to 4 hours, and for  $S$  and  $P$  – to 1 hour. This discrepancy is explained with the initial values (prediction) of the estimation parameters differing from the actual ones. It is obvious, that in a few hours the prediction and the estimation converge (i.e. the method ensures convergence).

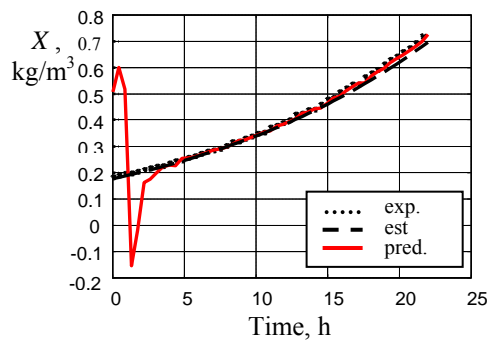


Figure 1.

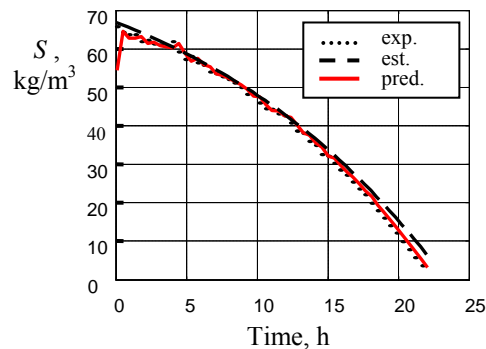


Figure 2.

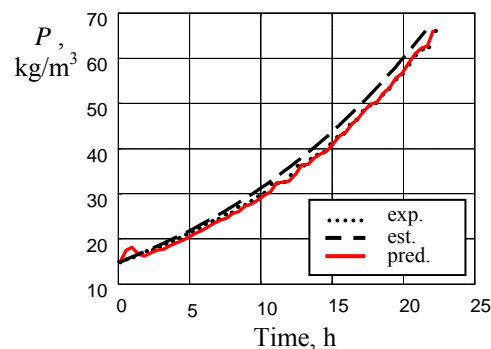


Figure 3.

At the end of the calculation process, the following values for the unknown coefficients are obtained:  $k_1=0.056$ ;  $k_2=0.058$ ;  $k_3=6.8$ ;  $k_4=5.6$ , where from by means of substitution under the designations in (2), for the technological parameters, we obtain:

$$\mu_m = 0.056 \text{ h}^{-1}; K_s = 0.058 \frac{\text{kg}}{\text{m}^3}; Y = 0.0082; \alpha = 0.82..$$

## CONCLUSION

The following major conclusions may be drawn from the obtained results, as illustrated in the figures:

- The recursion is fast converging to the state values and the parameters of the linearised model of the acetic acid fermentation.
- The Extended Kalman filter recursion may be used for estimation of parameters in the non-linear model of the acetic acid fermentation, and estimation and prediction of the basic processing values in this production process.
- The recursion may be applied for optimal control trough “on line” obtained estimation and prediction, in case any of the basic values are hard or inaccurate to measure.
- The algorithm is applied for one, two or three non observed (unmeasured) processing values. In case of all values being non-observed, the assessed and the predicted parameters of the non-observed values appear with larger rate of error.
- For the calculations necessary and employed is statistic data for the noise (variance matrix) obtained through simulated «white noises »;
- The recursion is not converging with initial conditions significantly different from the actual ones.
- In the algorithm a calculation issue may arise due to the matrix conditioning  $R(k)$ , that is inverted. The algorithm convergence accelerates, and better estimation is obtained at exponential decrease of step (matrix)  $R(k)$ ;
- The software elaboration of the researched method requires considerable computing resources with more unknown parameters and due to the fact that in each tact the model is being linearised.

## REFERENCES

- [1] Bessekerski V., Popov E., Theory of the Automatic Control Systems, Profession, Saint Peterburg, 2004.
- [2] Birjukov V., Kantare V., Optimization of the Synthesis of Periodic Microbiological Processes, Science, Moscow, 1985.
- [3] Mishkov R., Stojtchev. J., Models and control of nonlinear biotechnological processes. Sc. W. of UFT, v. LI, i.4, 255-260, 2004.
- [4] Rastrigin L., Madjarov N., Markov S., Estimation of Parameters and States of Dynamic Objects, Tehnica, Sofia, 1987.
- [5] Stanishkis J., Optimum Control of the Biotechnology Processes, MOKSLAS, Vilnius, 1984.
- [6] Stojtchev. J., Badev J., Mishkov R., Control and intezification of apple vinegar processes in continuous mode. Food processing industry magazine, №2, 46-49, 2010.
- [7] Conkov S., Filev D., Simeonov I., Vaklev L., Control of the Biotechnology Processes, Technica, Sofia, 1992.,
- [8] Yarovlenko V., Rovinski L., Modeling and Optimization of Microbiological Processes of the Alcohol Production, Food Industry, Moscow, 1978.
- [9] Kuo B.C., Automatic control systems, Prentice-hall international inc, New Jersey, 2002.



## ANALYSIS OF THE POSSIBILITY OF HEATING TOWN OF ZRENJANIN BIOMASS ENERGY

Dragiša Tolmač<sup>1</sup>, Zlatko Košut<sup>2</sup>, Jasna Tolmač<sup>1</sup>, Slavica Prvulović<sup>1</sup>

<sup>1</sup>University of Novi Sad, Technical faculty "Mihajlo Pupin", Zrenjanin, Serbia

<sup>2</sup>VICTORIAGROUP, Serbia

e-mail: [dragisatolmac@gmail.com](mailto:dragisatolmac@gmail.com)

**Abstract:** This paper considers the possibility of heating of Zrenjanin, using energy from biomass. Fuel wood pellets, derived from cereal straw. Victoria Starch Company, has two steam boilers of 2x16, 25 MW = 32.5 MW, and used as fuel pellets from biomass. This paper provides an overview of the available materials and the analysis of the cost of investments.

**Keywords:** heating city, steam boiler, biomass.

### INTRODUCTION

Consumer supply heat to the Zrenjanin was started in 1970. Year. Implementation of the "Jug" was conducted in 1971. The construction of the exchanger stations steam-hot water heat power of 12.5 MW and the main hot water line DN 400, which connected the "power plants" the existing consumers of thermal energy village 4 July and Little America. With the connection of new customers and increased power stations (steam-hot water) to 45 MW. Heating program from the city of Zrenjanin in 1976. was completed in 1981. construction exchanger stations power 90 MW. Of the heating season 2010/11., Started operating a new production plant with 70 MW of heat supply in the city of Zrenjanin, since due to the economic crisis, a lot of customers off the heat network. For the supply of heat to raspoladganju are 2 hot water boilers each with a capacity of 35 MW with fuel-natural gas.

### MATERIALS OVERVIEW AND ANALYSIS

Victoria Starch has two boilers for steam production capacity of 50 tons per hour ( 2 x 25 tons ) pressure 12 bar and temperature of 180 ° C, the motor fuel to biomass - pellets of straw cereals. Translated into thermal power is the max . 2x16 , 25 = 32.5 MW. So Victoria Starch , a capacity that can provide about 50 % of the existing heat production in Zrenjanin , with a very good business for the parameters in Victoria Starch and in city Zrenjanin . This startup of biomass boilers , it is possible to train and organize the work process steam production and pre-construction and commissioning of the plant for the production of starch . The energy value of a cubic meter of natural gas is theoretically 33.338.35 kJ/m<sup>3</sup> . (source Novi Sad gas <http://www.novisadgas.rs/korisnici/> official website ) The energy value of straw pellet weight is 16.500 kJ / kg (European Committee for Standardization, CEN TC335 committee under published 27 technical specifications ( preliminary standards) for solid fuels during the 2003-2006 year ( Alakangas , 2010) . These specifications are supplemented and adopted as European standards ( ENplus ) 2010. . ) <http://www.poljoprivrednatehnika.org.rs> The above data show that the two kilogram enough pellets to replace 1 m<sup>3</sup> of natural gas , and with the current price of 40,48 dinars. Production price of straw pellets is currently around 8 dinars / kg. Based on this, we have the following balance : 1m<sup>3</sup> gas = 2 kg pellets: 33.000 kJ/m<sup>3</sup> = 2 x 16.500 kJ / kg, 40,48 dinars ( = ) 16 dinars.

These data indicate that for the same amount of energy is required to extract 2.5 times less money. In Figure 1, which is attached hereto , owned by Victoria Starch are most necessary mechanical and technological equipment which would allow heating of the town .

### **Mechanical technological equipment and documentation that exists**

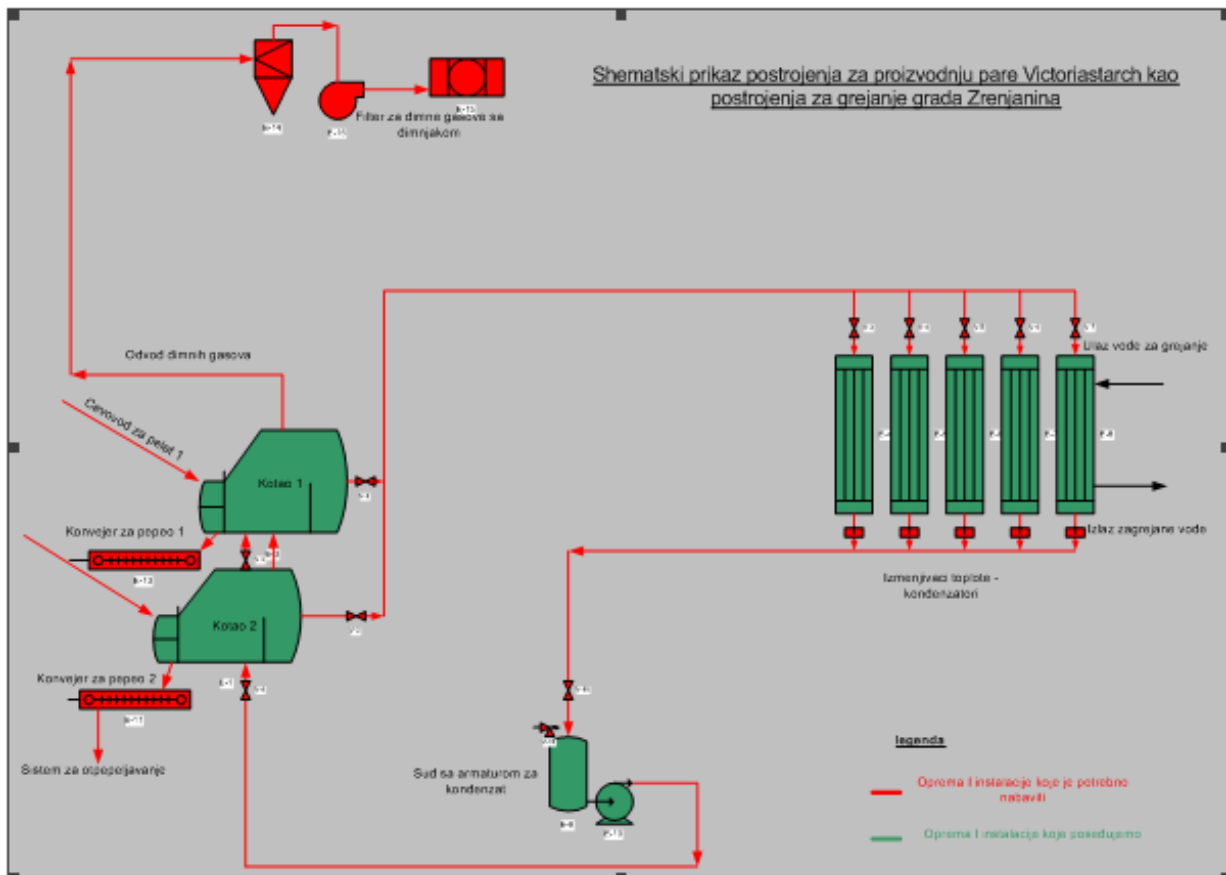
1. Boilers for steam production with equipment located in Victoria Starch company in Zrenjanin, capacity 2x25 t / h, of steam, which is 32,5 MW.
2. Projekti boiler construction are completed.
3. Heat exchangers, steam - heat hot water are located in Zrenjanin ( in the old sugar mill ) and requires repair. Surface heat is about 330 m<sup>2</sup>, which fully meets capacity.
4. Object for installation of boilers also exists but is in need of renovation - raising the roof on the existing design.
5. Pump for hot water circulation and the associated pumps also exist in the old sugar refinery
6. Well water supply and there is also a fully equipped
7. Supply electricity is provided - were repaired and put into operation the appropriate substation.
8. Drainage also trained and ready for use.

### **Mechanical technological equipment to be purchased**

1. Boilers service elements for which projects are part of the boiler ( chimney, filters, ash handling, transport- introduction of pellets )
2. Chemical treatment boiler water treatment capacity of 10 m<sup>3</sup> / h
3. Pipelines to connect boiler and heat exchanger as well as connecting with the city heating plant.

#### **Note:**

Items 1 and 2 in the equipment to be purchased are not only related to heat the city but a necessary condition for boiler works as an independent entity. Pipelines in item 3 can be used to transport money when you finish the construction of processing plant corn and stop your heating center. It should be noted that they are currently preparing a line of straw pelleting whose capacity will be around 4 t / h. That is the work of both the boiler at full capacity 24 hours a day need to install another line for straw pellet.



**Figure 1.** Technological scheme of plant steam production Victoriastarch and heating town of Zrenjanin

### ANALYSIS OF INVESTMENT IN PLANT CITY HEATING

Based on the data we PUC - District Heating delivers heat from October 15 until April 15, which means 183 days, on average, 14 hours (07.00 and 21.00), except for the cold days, on average, 20 days a year when the heat is supplied 24 hours a day. These data indicate that the boilers operate  $2282 + 480 = 2762$  hours per year. The data available to indicate that if the boiler is operating at full capacity - consumes about  $3545 \text{ m}^3 / \text{h}$ , of natural gas as the current gas price  $40,72 \text{ dinars/m}^3$ , is  $144.352 \text{ dinars / h}$ , if you count that one of the boilers to be leading in this case, the priority is heat produced in Victoriastarch-in, we get:  $8 \text{ RSD / kilo of pellets}$  (two pounds an energy equivalent to  $1 \text{ m}^3$  of natural gas), heat per hour is  $64.000 \times 3542 \times 8 \times 2 = 56.720 \text{ RSD / h}$ . At the level of the heating season gas heating costs  $398 \ 700 \ 224 \text{ dinars}$ , or  $\text{€ } 3,591,894$ . At the level of the heating season heating with pellets is  $156 \ 660 \ 640 \text{ dinars}$ , or  $\text{€ } 1,411,357$ . On the difference in price of about  $2,180,537 \text{ € / year}$ . One heating season, it is necessary economic analysis to the PUC District Heating, entered into cooperation with Victoriastarch included, but estimates show that for nearly two heating season comes to a complete repayment of investments so that the investment in the production of starch had fully repaid the boiler room .

**SPECIFICATION MECHANICAL-TECHNOLOGICAL EQUIPMENT WITH THE BILL OF QUANTITIES**

<b>A.</b>	<b>THE AMOUNT OF INVESTMENTS</b>		<b>comment</b>	<b>value €</b>
<b>A.1</b>	<b>BOILER PLANT</b>			
1.1	<b>Biomass boiler (2x25 t / h of saturated steam, p = 13 bar)</b>		there	
	Divorce steam, water, air		assessment	50.000
	+ Chimney flue ducts		assessment	200.000
	The steel structure, ladder, galleries			
	Insulation		assessment	150.000
	Deaerator, condensate tank			50.000
	Fire prevention - EAP			50.000
	Electrical works - Cabling			50.000
	<b>TOTAL (A1.1)</b>			<b>620.000</b>
1.2	<b>Feeding system boiler (2 kom.)</b>			
	Screw conveyors			40.000
	Silos			
	<b>TOTAL (A1.2)</b>		assessment	<b>50.000</b>
1.3	<b>Chemical treatment of water</b>			<b>50.000</b>
1.4	<b>+ Ash handling electrostatic</b>			
1.5	<b>Connecting the boiler with heat exchangers</b>			<b>150.000</b>
1.6	<b>Installation of heat exchangers with fittings</b>		assessment	<b>150.000</b>
	<b>TOTAL (A.1)</b>			<b>1.520.000</b>
<b>A.2</b>	<b>Building</b>			
	Construction Building - boiler		assessment	400.000
	The facility - storage			0
	Building - chimney, electric filter ...			100.000
	Building-adjusting heat			70.000
	<b>TOTAL (A.2)</b>			<b>570.000</b>
<b>A.3</b>	<b>INSTALLATION</b>		assessment	250.000
	<b>TOTAL ( (A.3)</b>			250.000
	<b>THE TOTAL INVESTMENT : (A.1-A.3)</b>			<b>2.340.000</b>

**THE PRICE WILL STEAM PRODUCTION AT THE VICTORIA STARCH**

Based on the information we have, the JKP - District Heating , delivers thermal energy of 15 October through 15 April, which means 183 days , on average, 14 hours ( 07.00 and 21.00 ) izuyev cold days , on average, 20 days a year when the heat is supplied 24 hours a day. These data indicate that the boilers operate  $2282 + 480 = 2762$  h / year ( data obtained from plants ) . If you calculate the maximum production of both the boiler 50 t / h of steam for one year - the heating season produced 89.753 MWh of energy - water vapor.

### ***1. Costs energy***

For one MWh of steam needed 295 kg of pellets of standard quality . A value of energy 8 din / kg of pellets , it is annually 211. 817. 080 dinars, or 1.908.262 € / year .

### ***2. Costs electricity***

Since we found that boiler work 2762 hours a year, while the installed electrical power of 1.2 MW for each boiler so that the boiler in the heating season to spend 3,314,400 kWh at a cost of 4.2 dinars / kWh, is one of the heating season 13,920,480 dinars, or € 125,184 / year .

Power is taken as the maximum installed capacity , ie . includes all associated equipment : conveyors , ventilation, chemical treatment of water and so on. , so that electricity for one year with part of the year when boilers will not work does not exceed the sum of € 150,000 / year .

### ***3. Costs chemical water***

Condensate return should be 90 % , if it goes into the calculation of 80 % then the required amount of DI water for boilers annually in the amount of 27.620 m<sup>3</sup>/god . Tenders for HPV calculated the price of demi water of 0.25 € / m<sup>3</sup> . If you zoom in on this price to 0.30 € / m<sup>3</sup> indicates that the annual cost of producing DI water € 8,286 / year .

### ***4. Costs maintenance***

Binding downtime for maintenance - cleaning boilers and maintenance recommended by the manufacturer of equipment ( lubrication replacement of consumable elements) as well as regular maintenance should not exceed € 30,000 / year .

### ***5. Costs compressed air***

Recommendations for this type of boilers that cost € 0.07 / per ton of money , which is : 9000 € / year.

### ***6. Costs workforce***

Given the legal occupancy of jobs needed for the četvorosmenski 8 executor of the boiler room and 4 for HPV , whose salary with shift work and public holidays will be around 850 euros per employee for a total workforce of € 122,400 / year .

### ***Total costs year on year***

1 +2 +3 +4 +5 +6 = 2.227,948 €

The total production of 89.753 MWh of steam Unit price of steam is 2.227.948 / 89.753 = 24,82 € / t , steam It is necessary to consider the potential unplanned downtime and failure to maintain the boiler on max mode, so it is necessary to correct the price by about 15 % , so that the price will be 28 € / MWh If we add to this price earnings of 25% of the price of steam heating plant to it was 35 € / MWh Price vapor which currently produces District Heating is 47.75 € / MWh (obtained from SM ) Based on the presented calculations , the remaining income : 89.753 x ( 47.75-35 ) =1.077.036 € / year.

## **CONCLUSION**

Supply of heat, JKP District Heating has 2 hot water boilers each with a capacity of 35 MW with fuel-natural gas.

Due to the economic crisis, a lot of customers off the heat, with heat networks. Victoria Starch, has two boilers for steam production capacity (2 x 25 t / h) = 50 t / h, pressure 12 bar and temperature of 180 ° C, the motor fuel to biomass - pellets of straw cereals. Translated into thermal power is the max. 2x16, 25 = 32,5 MW. The above data show that the two koligrama enough pellets to replace 1 m<sup>3</sup> of

natural gas, and with the current price of 40,48 dinars. Production price of straw pellets is currently around 8 dinars / kg. This is a production price in Victoriastarch. The price of pellets on the market or 20 dinars / kg. The budget cost of investment goes up with the price of pellets of 8 dinars / kg. Based on this, we have the following balance:  $1\text{m}^3 \text{ gas} = 2 \text{ kg pellets}$ :  $33.000 \text{ kJ/m}^3 = 2 \times 16.500 \text{ kJ / kg}$ , 40.48 dinars (=) 16 dinars. These data indicate that for the same amount of energy is required to extract 2,5 times less money. At the level of the heating season gas heating costs 398.700.224 dinars, or € 3.591.894. At the level of the heating season heating with pellets amounted to: 156.660.640 dinars, or € 1.411.357. The difference in price is about 2,180,537 €/ year. - One heating season. The total investment amounts to: € 2.340.000. Planned cost of production of water vapor in Victoriastarch-in, which takes into account all costs (fuel prices, the cost of electricity, water treatment chemical costs, maintenance costs and labor costs) is 35 € / MWh. Price vapor produced by the JKP - District Heating is 47.75 € / MWh.

Total potential production of water vapor in Victoriastarch-in is: 89.753 MWh. Based on the presented calculations, the remaining income:  $89\,753 \times (47.75 - 35) = 1.077.036 \text{ €/ year}$ .

**Payback time:  $2.340.000 / 1.077.036 = 2,17 \text{ years}$ .**

Construction Financing: 2.000.000 € -Victoriastarch  
340.000 € -JP City plant.

## REFERENCES

- [1] Tolmač, D. : Machinery and Apparatus, Technical Faculty "Mihajlo Pupin", Zrenjanin, 2009.
- [2] Tolmač, D. : Machines and Devices - Solved assignments, Technical Faculty "Mihajlo Pupin" Zrenjanin.2006.
- [3] Tolmač, D. : Design of Technology Systems - Production Systems - Faculty of Engineering "Mihajlo Pupin", Zrenjanin, 2008.
- [4] Tolmač, D. : Production and Process Systems - Collection of solved problems, Technical Faculty "Mihajlo Pupin" Zrenjanin.2008.
- [5] Tolmač, D., Prvulović, S., Radovanovic, LJ, Blagojević, Z. : Theory of System Design - design, investment, re-engineering, Technical Faculty "Mihajlo Pupin" Zrenjanin.2007.
- [6] Tolmač, D. : Design, Technical Faculty "Mihajlo Pupin", Zrenjanin, 2009.
- [7] Tolmač, D., Prvulović, S. : Process engineering and management in industrial engineering, Technical Faculty "Mihajlo Pupin", Zrenjanin, 2010.

## EFFECTS OF SUPERPLASTICIZING AND RETARDING ADMIXTURES ON PROPERTIES OF CONCRETE

Salahaldein Alsadey

Faculty of Engineering, Civil Engineering Department Beni Walid, Azzaytuna University,  
Libya

e-mail: [salahalsadey@yahoo.com](mailto:salahalsadey@yahoo.com)

**Abstract:** The adverse effects of elevated temperatures on the properties of the fresh concrete include increased water demand, shorter setting time and increased slump loss. Superplasticizers (SP) and retarders are important to enhance the workability and setting time of concrete under hot weather, hence, an experimental investigation was conducted to determine the optimum dosage for the admixtures and to study the effect of over dosage of the mentioned admixtures. Concrete mixes with SP and retarder dosages of 600, 1200, 1800, and 2500 ml/100 kg of cement were prepared, together with control mix (water/cement ratio were 0.50 ). After casting, normal curing was carried out on the concrete samples. Properties such as compressive strength, was determined, besides determining the workability of the fresh concrete. Over dosage of SP or retarder were found to deteriorate the properties of concrete with indication of lower compressive strength. However, if the dosage levels are lower than the optimum dosage, increase in admixture dosage might help to enhance the concrete characteristics.

**Key words:** Concrete; Admixtures; Superplasticizers; Retarders; Compressive Strength.

### INTRODUCTION

In Libya, about 90-95 percent of the construction materials market for both structural and non-structural applications is made of concrete compared with other materials used for similar functions. Concrete, generally, is a product made from cement, water and aggregates and an additional material known as admixture, is sometimes added to modify certain properties of concrete. Cement is the chemically active constituent but its reactivity is only brought into effect upon mixing with water. The aggregate plays no important roles in chemical reaction but its usefulness arises because it is an economical filler material or hard composite material with good resistance to volume changes which take place within the concrete after mixing, besides improving durability of concrete. In hardened state, concrete is a rock like material with a high compressive strength. In its plastic state, concrete may be moulded into any form of shapes, it may be used to advantages architecturally or solely for decorative purposes. Concrete has low tensile strength, and hence, this is the reason why it is used with steel bar to resist any tensile forces in the reinforced concrete.

Concrete is usually used in building for foundations, columns, beams and slabs, in shell structures, bridges, sewerage treatment plants, roads, cooling towers, railway sleepers and so on. In precast concrete industry, concrete is widely used as concrete blocks, cladding panels, pipes, piles and lamp posts [1]. Nowadays, more than 70% of in-situ concrete in Libya is produced by the ready mixed concrete industry. The ready mixed concrete producers are using retarding and superplasticizing (SP) admixtures which are readily available from various manufacturers. Retarding admixture decreases the initial rate of reaction between cement and water, and hence, retards the setting time of concrete. Retarders are admixtures which will lengthen the setting time and workability retention, particularly important for concreting in hot weather. A retarding admixture holds back the hydration process, leaving more water for workability and allowing sufficient time for the concrete to be placed, compacted and finished. Superplasticiser (SP) is used to increase the workability without changing the water/ cement ratio. Or, it can be used to increase the ultimate strength of concrete by reducing water content while maintaining adequate workability. This experimental work is carried out to study the effect of dosage of retarder and SP on properties of concrete. Since in some cases at job site, it is found that the concrete is left unset for 2 to 3 days due to over dosage of retarding admixture and it becomes very common and serious in the concrete practice.

Superplasticizer is a type of water reducers; however, the difference between superplasticizer and water reducer is that superplasticizer will significantly reduce the water required for concrete mixing [2]. Generally, there are four main categories of superplasticizer: sulfonated melamine- formaldehyde

condensates, sulfonated naphthalene- formaldehyde condensates, modified lignosulfonates and others such as sulfonic- acid esters and carbohydrate esters. Effects of superplasticizer are obvious, i.e. to produce concrete with a very high workability or concrete with a very high strength. Mechanism of superplasticizer is through giving the cement particles highly negative charge so that they repel each other due to the same electrostatic charge. By deflocculating the cement particles, more water is provided for concrete mixing [2]. For general usage, dosage of superplasticizer is between 1- 3 l/m<sup>3</sup>. However, the dosage can be increased to as high as 5- 20 l/m<sup>3</sup>. Since concentration of superplasticizer is different, any comparison of performance should be made on the basis of the amount of solids, and not on the total mass. Effectiveness of a given dosage of superplasticizer depends on the water/cement ratio. Effectiveness increases when w/c decreases. Compatibility with actual cement is one of the most important parameters that needed to be considered, and it is not recommended that the cement and superplasticizer conform the standard separately [2]. There are few advantages obtained when superplasticizer is used: produce high workability concrete with constant cement content and strength, with objective for easy placing and compaction; produce concrete with normal workability, but lower water requirement; production of concrete with combination of high workability and low water content; and designing a normal strength and workability concrete with less cement content [3]. Retarders might slow down the strength development of concrete, however, it does not alter the composition of the hydration product [4]. Most publications categorized these admixtures under 'water reducing and set retarding admixtures' due to their effects as stated in standard requirements for the initial setting time. However, there are still other different characteristics that distinguish them, which include water requirement and compressive strength [3]. Generally, retarders are used in hot weather, where high temperature could shorten the setting time of concrete, which in the end will lead to the formation of cold joints. With longer period of setting, the transportation, placing and compaction of concrete can be done when the fresh concrete is still in plastic state. Sometimes, it can affect the structural design by allowing continuous massive pours with controlled retardation, instead of segmental construction. Great care should be paid when using retarders because over dosage will inhibit the setting and hardening of concrete [4]. In addition, retarders can significantly reduce the heat generated during hydration of concrete. The reduction in heat can avoid cracking of large structure such as large dams. Good workability can be achieved by incorporating retarders in the concrete, which will delay the setting time and allow suitable compaction done without segregation [4].

## OBJECTIVES

The followings are the objectives of the study, which include:

- To determine the optimum dosage of concrete retarder and superplasticizer for normal concrete.
- To investigate the effects of superplasticizer and retarders on properties of concrete.

## EXPERIMENTAL PROGRAM

This study will focus on normal strength concrete with characteristic strength of 30 Mpa at 28 days, which used Ordinary Portland Cement (OPC) as binder, 20 mm granite coarse aggregate and sea sand. Libomont-FF as superplasticizer (ASTM C-494 Type F and BS 5075 Part3), and Libocrete-VZ as retarding (ASTM C 494 Type A+B+D and BS 5075 Part I). One control mix will be prepared without the use of any admixture. To investigate the effects of superplasticizer and retarder, four additional mixes were prepared using admixture dosage of 600, 1200, 1800, and 2500 ml/ 100 kg of cement. Slump test used to assess the workability of the concrete mixes. Compressive strength used to determine on concrete cube at 7, 14 and 28 days. All samples for hardened concrete test cured in water maintain at temperature of  $27 \pm 2^\circ\text{C}$  (BS 1881: Part 111: 1983). However, 72 specimens with the dimension of 150 mm x 150 mm x 150 mm fabricated in the Structural Engineering Laboratory of Azzaytuna University Libya.



## RESULTS AND DISCUSSION

From this study, the results obtained due to the lab tests done for mechanical properties of the concrete such as compressive strength. On the other hands, for workability of the fresh concrete, only slump test has been done to get the fresh properties of the concrete due to the time constraint.

### Effect of Superplasticizer and retarder on Slump loss

The results for slump loss of superplasticized and retarded concrete are shown in Figures 1 and 2. The data are recorded and being shown to observe the relation between dosages of SP/ retarder and slump loss. The values of slump loss for different dosages of SP and retarder as show in Graphs above the slump against elapse of time for different dosages of SP and retarder. From the graph, it is clear that slump reduces with time. It is acceptable since continuous hydration process will produce calcium silicate hydrate to fill the pores between the cement particles and aggregate. As a result, setting of the concrete will reduce the fluidity of concrete, hence, reduce the slump too. When observation is done on the content of SP and retarder, increase in dosage of the chemical admixtures will decelerate the rate of setting of concrete, since both the SP and retarder will help to retain the concrete in liquid state for a longer time, and hence, reduce the slump loss during the transportation of concrete to the site. However, over dosage of these admixtures will lead to high slump loss, which will not give true slump that as what we expect and desire. If comparisons are made between the SP and retarder, the setting time for retarded concrete is longer than the superplasticized concrete. After 300 minutes (5 hours. As a result, conclusion is made that retarder is more effective in retaining the slump of the concrete than the SP does at the same dosage.

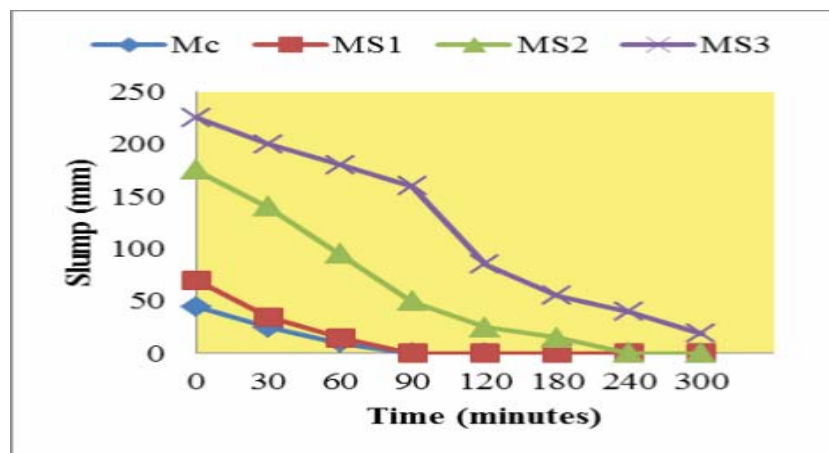


Figure 1: Effect of SP dosage on workability loss based on slump

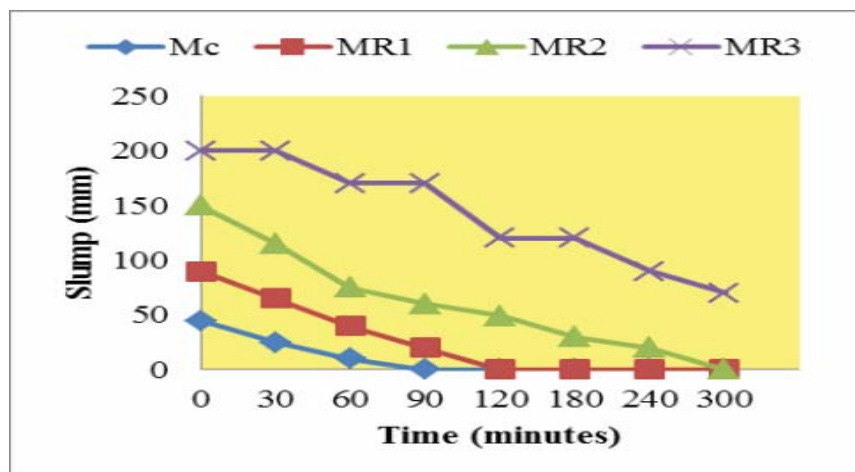


Figure 2: Effect of retarder dosage on workability loss based on slump

### Effect of SP and retarder on compressive strength

Compressive strength of concrete with different dosage of superplasticizer and retarder are shown in Tables 1 and 2. This test is performed on 7, 14 and 28 days. The values of compressive strength for the different dosage of superplasticizer/ retarder are then shown as a graph in Figures 3 and 4. After conducting the experiment, graph of compressive strength versus age of concrete is plotted. From the graph, continuous strength gain for both chemical admixture is observed by the increase in compressive strength with age. At early age (7 days from casting), the rate of strength gain is high since the reaction between the cement particles and water is active. When time goes by, the rate become lower, and hence, the slope of curve for age 14 to 28 days is less steep compared with its early age.

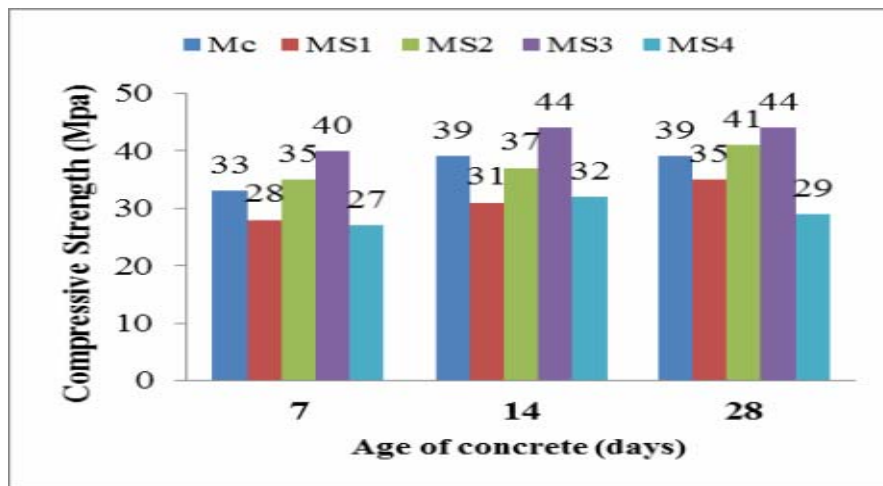
**Table 1:** Compressive strength of superplasticized concrete

Concrete mix	Compressive strength in Mpa		
	7days	14 days	28days
Control (M)	33	39	39
600ml/100 kg of cement(MS1)	28	31	35
1200ml/100 kg of cement(MS2)	35	37	41
1800ml/100 kg of cement(MS3)	40	44	44
2500ml/100 kg of cement(MS4)	27	32	29

When we observe the effect of dosage of the admixtures, both admixtures present different behaviours on the compressive strength of concrete. At early age, addition of retarders not able to increase the compressive strength of concrete, on the other hand, it reduces the strenght significantly, and become worse when the dosages increase. The reason for this phenomenon is that addition of retarder to the concrete will delay the reaction of  $C_3S$  and  $C_3A$ . As a result, strength development is low. The situation varies only after 7 days from casting, where inclusion of retarder will slightly improve compressive strength at later age. For SP, increase in dosage will increase the compressive strength for all ages. Since addition of SP will provide more water for concrete mixing, not only the hydration process will not be disturbed, but, it is accelerated by the additional water from deflocculation of cement particles. Hence, increase in dosage will increase the entrapped water and promote hydration of cement. Though increment in dosage of admixture will enhance the compressive strength, there is still an optimum limit for the usage of admixture. When the dosages go beyond this limit, increase in dosage will only reduce the compressive strength.

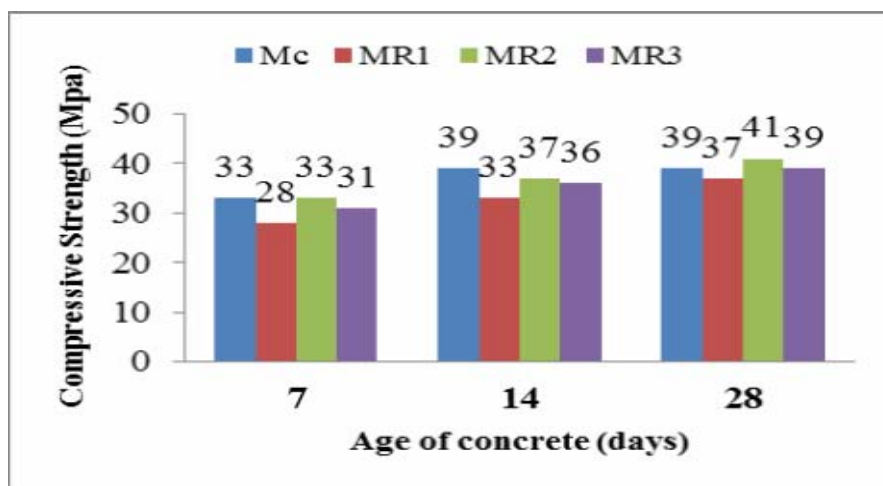
**Table 2:** Compressive strength of retarded concrete

Concrete mix	Compressive strength in Mpa		
	7 days	14 days	28 days
Control (M)	33	39	39
600ml/100 kg of cement(MR1)	28	33	37
1200ml/100 kg of cement(MR2)	33	37	41
1800ml/100 kg of cement(MR3)	31	36	39



**Figure 3:** Compressive strength of concrete with different dosages of superplasticized

This phenomenon occurs since over dosage of retarder or SP will cause bleeding and segregation, which will affect the cohesiveness and uniformity of the concrete. As a result, compressive strength will reduce if the used dosage is beyond the optimum dosage. If observation is done on the efficiency in increasing compressive strength, SP perform better than retarder. For early age, compressive strength of concrete containing SP exceeded 12 MPa for all dosages, and this value is higher than the compressive strength of the control, whereas, performance of retarder is not satisfactory, with neither dosage of retarder can enhance the compressive strength to become higher than the control. However, for long term compressive strength, both SP and retarder give acceptable result, where the compressive strength achieve exceeds 40 MPa, which is higher than the desired characteristic strength of 30 MPa. Optimum dosage of SP and retarder are found based on the highest ultimate strength that they present at age 28 days. Dosage with lower or higher than this optimum value will reduce the compressive strength. For more accurate and precise result, more dosages should be done with smaller interval for a better fit curve.



**Figure 4:** Compressive strength of concrete with different dosages of retarded

## CONCLUSIONS

This paper was conducted to study the effects of superplasticizer and retarder on properties of concrete with characteristic strength of 30 Mpa. The properties investigated were workability (slump), and compressive strength. However, the conclusion, which follow are drawn based on experimental results and observations presented earlier in the paper. These conclusions are of necessity specific to this study, being related to type of superplasticizer and retarder, environmental condition during testing, testing method, etc. Nevertheless, the findings of this investigation should provide a significant

contribution towards the knowledge on the effect of superplasticizer and retarder on properties of concrete. The properties of concrete containing SP and retarder had been successfully studied. From the results of the study presented earlier, the following conclusions are offered:

- The workability of concrete can be increased by addition of superplasticizer and retarder. However, very high dosages of both admixtures tends to impair the cohesiveness of concrete.
- Slump loss can be reduced by using the chemical admixtures. However, effectiveness is higher for superplasticized concrete.
- Inclusion of SP and retarder in concrete enable concrete to have a better cohesiveness without segregation. However, at very high dosages, cohesiveness reduces.
- Compressive strength is improved by SP for all ages. On the other hand, retarder present lower compressive strength compared with control at early age, even its ultimate strength is higher than the desired characteristic strength.

### Recommendation

The following are few recommendations that can be done to further enhance the usefulness of the experiment:

- Inclusion of both chemical and mineral admixtures
  - Since both SP and retarders help to increase workability of concrete, their usage on concrete containing mineral admixtures such as silica fume or metakaolin should be studied in depth to determine whether ultra-high strength concrete (100 – 150 Mpa) can be produced using these chemical admixtures
- Effects of various types of admixtures used
  - Since different kinds of admixture will react differently when contacts with cement even though they are categorized in the same type, therefore, study should be done to determine which admixture perform better under certain exposure condition.
  - Comparisons can be made between the admixtures so that the most suitable admixture could be chosen for a given job.
- Determination of accurate optimum dosage
  - Since there are only 4 dosages of admixture used, accurate optimum dosage of admixture is difficult to estimate. For this reason, more concrete mixes that contain different dosages of admixtures should be prepared in order to obtain the precise optimum dosage of admixture through the best fit line drawn on the graph.

### REFERENCES

- [1] Tanaka M., Matsuo S., Ohta A. and Veda M., A New Admixture for High Performance Concrete, Proceedings of the "Concrete in The Service of Mankind", Editors: R.K. Dhir and M.J. McCarthy, pp. 291-300 (1996).
- [2] Properties of Concrete – A. M. Neville, 2005
- [3] Ramachandran, C. K., Hignite, C. E., Gray, S. L. & Melnykovich, G. Concrete Admixtures Handbook - Properties, Science, and Technology, (1981) Biochem. J. 198, 23-28.
- [4] Neville, A.M., "Properties of Concrete", 4th. Ed., John Wiley & Sons, Inc., New York, NY, Pitman Publishing Ltd., London, 844 pp, (1998).
- [5] Properties of Concrete – A. M. Neville, 2005
- [6] British Standard Institution, BS 1881 : Part 102 (1983). " Methods for Determination of Slump".
- [7] British Standard Institution, BS 1881 : Part 116 (1983). " Methods for Determination of Compressive Strength of Concrete Cube".
- [8] British Standard Institution, BS 1881 : Part 3 (1970)." Methods of Making and Curing Test Specimens".
- [9] ACI- Committee 212,"Guide for the Use of High-Range Water Reducing Admixtures (Superplasticizers) in Concrete" ,ACI Manual of Concrete Practice,2004.
- [10] ASTM C494/C494M-04, "Standard and Specification for Chemical Admixtures for Concrete", Annual Book of ASTM Standards, Vol.04.02,2004.

## SUSTAINABLE DEVELOPMENT HEAT PUMP

Dragan Škobalj, M. Opsenica

Internacionalni univerzitet Brčko distrikt Bosnia and Hercegovina

**Abstract:** Due to growing environmental awareness and resulting concerns, refrigerants - the working fluids for refrigeration systems, heat pumps and air conditioners - have gained considerably attention well known proven fluids were banned and replaced. The thermodynamics of mixtures is considerably more complex than that of pure fluids. This text is dedicated to introducing the thermodynamic theory and back-ground of working fluid mixtures and at providing the practicing engineer, as well as the aspiring engineering student, with all the necessary information to successfully design systems. Emphasis is placed on practical experience from laboratory investigations. On many occasions, a fluid needs to be cooled below the temperature of the surroundings.

**Key words:** environmental awareness, refrigerants, heat pumps, thermodynamic mixture, practical experience

### INTRODUCTION

Due to growing environmental awareness and resulting concerns refrigerants, the working fluids for refrigeration systems, heat pumps and air conditioners, have gained considerable attention. Well known proven fluids were banned and replaced with new ones. In this process, refrigerant mixtures were introduced to achieve acceptable properties of mixtures is considerably more complex than that of pure fluid. This paper is dedicated to introducing the thermodynamic theory and back-ground of working fluid mixtures and their practical implementations. It discusses the opportunities and challenges and aims at providing the practicing engineer, as well as the aspiring engineering student, with all the necessary information to successfully design systems that take the best possible advantage of fluid mixtures.

Emphasis is placed on practical experience from laboratory investigations. On many occasions a fluid needs to be cooled below the temperature of the surroundings. Examples are the production of chilled water or brine for air conditioning and refrigeration purposes or the cooling of air to conditioning space. In this context the term “cooling” usually implies a certain quantity of energy is extracted from a fluid while reducing its temperature. This energy is rejected to a second fluid at a higher temperature than that of the first fluid. For example in a domestic refrigerator energy is extracted from the air inside the cabinet, reducing its temperature and cooling the cabinet. In turn energy is rejected from the refrigeration unit to the surrounding air, heating the exterior. When energy transfer is based on a temperature gradient one speaks of heat transfer. In this strict sense, “heat” exists only as long as a temperature gradient enables this transfer of energy. However, in the field of refrigeration and air-conditioning, the term “heat” is used more loosely and is understood as energy in more general terms. This text adheres to this latter convention.

### HEAT PUMPING

In general the machines that accomplish the lift of a certain quantity of energy from a lower temperature level to a higher one are termed heat pumps. The thermodynamic processes involved in heat pumping are governed by the first and second laws of thermodynamics. The first law is the conservation of energy and reads.

$$\sum Q_i + W = 0 \quad (1)$$

where Q stands for the amounts of heat exchanged at various temperature levels  $T_i$  and W for the amount of work that is required in the process. The second law states that heat cannot flow from a lower to a higher temperature without the expenditure of energy. One way of expressing this statement is shown in the following equation:

$$\sum \frac{Q_i}{T_i} = 0 \quad \text{for reversible processes} \quad (2)$$

Equation 1 is based on the assumption that the energy supplied to a system is counted as positive. Figure 1 illustrates the situation. The vertical axis is the temperature axis with increasing temperature from the bottom to top i.e.,  $T_1 < T_2$ . A certain amount of heat is removed by the device M at temperature  $T_1$  and, by using work that is supplied to M, heat is rejected at  $T_2$ . The amount of heat rejected is the sum of the amount of work  $W$  required by M and the amount of heat removed at  $T_1$ . This is a consequence of the first law,

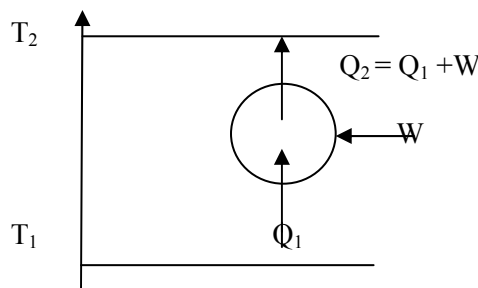
$$Q_1 + W = Q_2 \quad (3)$$

However does this relationship of Figure 1 fulfill the second law, equation 2? Applying equation 2 to the situation of Figure 1 yields.

$$\frac{Q_1}{T_1} - \frac{Q_2}{T_2} = 0 \quad (4)$$

and using Equation 3

$$\frac{Q_1}{T_1} - \frac{Q_1 + W}{T_2} = 0 \quad (5)$$



**Figure 1.** Heat pumping – The process of lifting energy  $Q_1$  from a temperature level  $T_1$  to  $T_2$ , releasing  $Q_2$ . The input energy, in this case work  $W$  is required

After rearranging the terms, we find

$$\frac{Q_1}{T_1} - \frac{Q_2}{T_2} - \frac{W}{T_2} = 0 \quad (6)$$

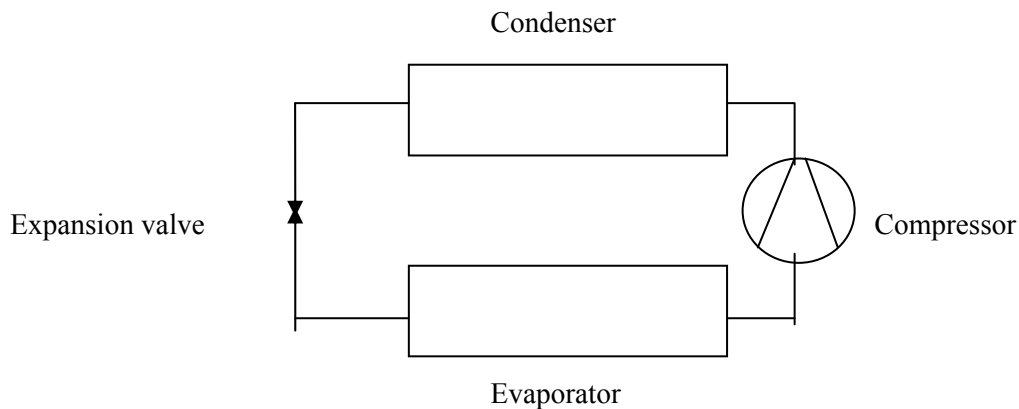
Since  $T_2 > T_1$ , the difference of the first two terms is still larger than zero. Equation 6 requires that the second law is fulfilled only if the work input is sufficiently large. Thus, there is a minimum work requirement.

This minimum amount of work is required for the system to operate reversibly. The second law does not say anything about an upper limit for the work, so the system may be very inefficient and operate irreversibly if  $W$  becomes much larger than necessary. There is no upper limit on the degree of irreversibility for the heat pumping operations. The first and second laws state for lifting heat from one temperature level to a higher one, the expenditure of energy is required and that the amount of energy rejected at the higher temperature level is the sum of the heat removed from the lower temperature level plus the energy added to accomplish the lift. The energy required to drive the system can be supplied in the form of work as assumed here, or it can be supplied in the form of heat. Examples are absorption heat pumps, desiccant systems and engine-driven heat pumps.

One of the most common implementations of a heat pump is shown in Figure 2. Liquid refrigerant evaporates in the evaporator at a given pressure level while it absorbs heat. In other terms, this is the cooling effect. The compressor compresses the vapor that exits from the evaporator and delivers the compressed, high pressure vapor to the condenser where the vapor is cooled and condensed. The liquefied vapor leaves the condenser and enters the expansion valve. This valve reduces the pressure level and meters the fluid so that as much refrigerant enters the evaporator as the compressor removes.

The concept shown in Figure 2 represents a vapor compression heat pump. It is the underlying concept of the type of heat pumps discussed in this text.

All of these systems have to fulfill the first and second law in the form of the equations 1 and 2. It should be noted that although both the first and second law must be observed in heat pump design.



**Figure 2.** Schematic of a vapor compression heat pump (or refrigeration system)

The following sections provide an over view of various heat pump applications. Note that whenever energy is lifted from a lower temperature to a higher temperature we speak in general of a heat pumping process. However for many applications, the process is not as important as its result. In all refrigeration and air-conditioning applications energy is removed from a lower temperature level and rejected at a higher temperature level. The main effect that interests the user is the refrigeration or cooling effect, i.e., heat removal. On the other hand in what is customarily called heat pumping, the user is interested in the heat delivered at the high temperature level. In both cases the underlying thermodynamic process is the same, only the application on the desired benefit are different. In this text, the term heat pumping is used as the general description for the thermodynamic process independent of the application. The terms refrigeration and air-conditioning refer specifically to the application

## OVERVIEW OF CURRENT PRODUCTS

Vapor compression heat pump systems have found many applications spanning wide range of capacities. This text will give an overview of applications, systems configurations and the economic importance of vapor compression systems.

The global market for air-conditioning and refrigeration equipment is estimated to be \$ 42 to 45 billion, with the United States and Japan each covering one third of the worldwide production followed by Europe and China. In terms of applications the market is split into thirds as well. One third covers residential air-conditioning one third refrigeration (mostly food preservation), and one-third commercial air-conditioning. In the United States stationary refrigeration and air-conditioning systems are used for 45 million homes and commercial buildings as well as 100 million refrigerators and 30 million freezers.

### Residential air-conditioners and heat pumps

In the United States, residential air-conditioning has become very common and even used in the colder region of the north. The units are usually, split systems, referring to the fact that the air conditioner is split into two units. The evaporator together with the expansion device is located inside the building and condensing unit, consisting of compressor and condenser is located outside. The piping connection is installed in the field, which is also where system is charged with refrigerant. The cooling capacity ranges from 3 to 18 kW. Around 18 % of these units are designed as called heat pumps. They have a four-way reversing valve that allow the same unit to serve as an air conditioner in the summer

months and as a heat pump in the winter. Since traditionally the system is designed and sized for the air-conditioning function, the heat pumps turn out to have insufficient heating capacity in most climates. Supplemented heat in the form of electric or gas heat is usually required. Another form of residential air-conditioning is the window air conditioner. It is designed to cool just one room and the largest capacity does not exceed 7 kW. All the component are integrated within one chassis that is usually mounted within the frame of a window.

### **Commercial air conditioning systems**

Commercial air-conditioning systems span a wide range of capacities. The larger ones usually employ variable speed centrifugal compressors and low pressure refrigerants for high efficiencies. They are designed to produce chilled water at about 5 to 7 °C and are cooled by water that in turn rejects heat to the ambient in a wet cooling tower. The chilled water is supplied to air-handling units located throughout the building. It is interesting to note that many commercial buildings require cooling year-round because these buildings have considerable internal heat loads resulting from the presence of occupants and equipment that generate heat. A considerable floor area of useful space is located within the core of the building. This interior space is surrounded by other rooms that have outside walls but these perimeter rooms are always maintained at a constant temperature. This, the interior space has no way of rejecting heat and require cooling year-round. In newer systems a so-called economizer allow the use of outdoor air for core cooling whenever weather conditions are suitable.

Recently, a new generation of chillers emerged that are vapor compression cycles driven by internal combustion engines. The primary energy input is gas rather than electricity and the new generation chillers reduce the reliance on costly peak power and help, to avoid high demand charges.

For smaller buildings or those with a limited number of stories, so called rooftop units are used. These are air conditioning systems that reach up to 700 kW in capacity, and have the air handler integrated within the unit, often including a heating device such as a gas furnace.

### **Industrial systems**

Industrial refrigeration systems serve a wide range of purposes. They include food storage in large warehouses to the provision of cold utilities in chemical plants, refineries and polymer production facilities. Further many production facilities such as printing, spinning, electronics and precision machining require very stringently controlled thermal environment. Many machines for industrial refrigeration and air conditioning are custom-manufactured to meet specific criteria.

### **Refrigeration systems**

Probably the most important and earliest application of refrigeration technology was that of food storage. Today, the technology has developed into a complete cold chain in which food products such as fish, meats, dairy products and vegetables are cooled or refrigerated from the moment of harvest of production through storage, transport, wholesale and retail to the consumer, who uses the residential refrigeration as the last storage facility in the chain. Accordingly, a wide range of refrigeration systems have been developed that meet the various needs.

The domestic refrigerator is a unique device in that it has reached such a level of maturity that some units last more than 20 years without over failing or requiring maintenance. In addition, the energy consumption has been reduced by more than a factor of two over the past 30 years. The newest models of a typical refrigerator for a U.S. household show a power consumption that is equivalent to that of a 50 W light bulb left on continuously.

Refrigeration systems in super market usually have central compressor plant with multiple compressors in parallel that serve the same set of evaporators. The evaporators are located throughout the store in the display cabinet for frozen or refrigerated foods. As a consequence, a single store can boast miles of refrigerant piping. Due to the length of piping and the many inherent piping connections, supermarket refrigeration systems tended to lose considerable amounts of refrigerant. With the advent of environmental concerns and improved quality standards, these leakages have been reduced considerably. New systems are under consideration in which the refrigerant does not leave the



machine room. Rather, a secondary refrigerant is needed to cool the display cabinets. This measure reduces refrigerant leakage and increases system reliability, but may contribute to a reduction in energy efficiency.

Transport refrigeration systems especially those that are trailer or container mounted, must come with their own power supply, usually a small diesel or gas engine. Systems must be especially robust to withstand the high vibration levels. Also, these systems must be designed to cover a wide range of operating conditions. The transported goods may require storage temperatures ranging from -40 to 20 °C while the ambient temperature can span even a wider range of temperatures.

For food preservation there are also a wide array of specialized required cooling systems. Examples are milk coolers on farms, cooling systems for tank trucks and refrigeration systems ranging from fish trawlers to wine coolers.

The air conditioning of cars has become an expected feature in the United States and many developed and developing countries. The cooling capacity varies over a wide range because the compressor is directly coupled to the engine and the compressor revolution varies with that of the engine. Furthermore, due to vibration and the need to use flexible hoses to connect the components that are mounted on the car and these mounted engine block, these systems traditionally have a relatively high rate of refrigerant leakage. With the advent of environmental concerns, these leakage rates have been reduced dramatically.

## HISTORY OF WORKING FLUIDS

The first and second law state only the conditions and limitations under which machinery such as refrigeration systems can operate. The actual implementation is not prescribed by these laws. It is common practice in the refrigeration industry to employ the vapor compression cycle of Figure 2.

To do so requires the use of working fluids, commonly termed refrigerants. They represent one of the key ingredients of any vapor compression system and influence design operation and cost immensely. A short overview of the historical development of refrigerants follows that provides insight into the development of refrigeration systems. The following is an excerpt of a paper presented by Calm and Didion [5] in 1997.

Refrigeration goes back to ancient times, using stored ice and a number of evaporative processes. Early in the 19<sup>th</sup> century, the use of a volatile fluid in a closed cycle was proposed by Oliver Evans [13]. He used evaporating ether, under a vacuum, and then pumped the vapor to a water-cooled heat exchanger to be condensed for reuse.

Other refrigerants were introduced in the 1830s with the invention of the vapor compression machine by Perkins [25]. He designed a machine actually used caoutchoucine, an industrial solvent that Perkins apparently utilized in his business as a printer. It seems the first trade-off in refrigerants – and one still driving selections – was based on availability.

The first century of refrigerant use was dominated by innovative efforts with familiar fluids. The goals were to provide refrigeration and later to improve machine durability. Use of blends was attempted where single-component solutions could not be found (Pictet 1985) [27]. After World War I, attention turned to safety and performance as well. Willis H. Carrier and Waterfill [6], initiated one of the first documented systematic searches (Carrier and Waterfill, 1924) [6]. They investigated a range of candidate refrigerants for suitability for both positive displacement and centrifugal compression machines. These analyses closely examined ammonia, ethyl ether, carbon dioxide, carbon tetrachloride, sulfur dioxide and water. They finally selected dielene (1,2-dichloroethane, R 1130) for the first centrifuge machine, though an international search was needed to find a source for it (Ingels, 1952) [17].

Nearly all of the early refrigerants were flammable, toxic or both, and some were also highly reactive. Accidents were common. For perspective propane was marketed as the odorless safety refrigerant (CLPC, 1922).

The discovery of fluorinated refrigerants began with Thomas Midgley, JR., [23] in 1928 (Midgley, 1937). [24] Midgley and his associates, Albert L. Henne and Robert R. McNary, scoured chemical tables to find chemicals with the desired boiling point. They restricted the search to those known to be stable but not toxic or flammable. They eventually used organic fluorides. While fluorine was known to be toxic by itself, Midgley and collaborators felt that compounds containing it could be nontoxic

recognizing the deficiencies of the published literature, Midgley, Henne and McNary turned to the periodic table of the elements. They quickly eliminated those elements yielding insufficient volatility and then eliminated those resulting in unstable and toxic compounds as well as the inert gases, based on their low boiling point. They were left with just eight elements: carbon, nitrogen, oxygen, sulfur, hydrogen, fluorine, chlorine and bromine. These elements clustered at an intersecting row and column of the periodic table of the elements, with fluorine at the intersections.

Midgley and his colleagues then made three interesting observations. First flammability decreases from the heavy elements at the bottom to the lighter elements at the top. And third, every known refrigerant at the time was made from combinations of these elements. The historical fluids actually comprised only seven of the eight Midgley elements, since there appears to be no record of prior use of refrigerants containing fluorine. The first publications on fluorochemical refrigerants show how chlorination and fluorination of hydrocarbons can be varied to provide desired boiling point (Midgley, 1930) [24]. This paper also shows how the composition of the molecule influences relative flammability and toxicity. Commercial production of R12 began in 1931, followed by R11 in 1932 (Downing, 1966 and 1964) [10]. Other investigators have repeated Midgley's search with newer methods and modern databases and have come to similar findings, McLinden and Didion (1987) [20] documented an extensive screening of industrial chemicals. Of the chemicals meeting their criteria, all but two – both highly reactive and toxic – contained the Midgley element.

## REQUIREMENTS FOR WORKING FLUIDS

Refrigerants are expected to meet certain criteria in order to be found acceptable by industry and users. However, with increasing environmental concerns, the set of criteria increases. It becomes more and more difficult to find fluids that meet all or even most requirements. Future refrigerant choices will always be a compromise. The following criteria should be fulfilled:

- Lack of corrosion, chemically inert. Refrigerants should not corrode any construction materials present in the system. Also they should not react with any fluids in the system (such as compressor lubricants).
- Lack of toxicity. For the safety of manufacturing and service personnel refrigerant must be nontoxic.
- Nonflammable. To avoid accidents caused by any sources of intense heat or ignition (such as propane torches used by repair personnel or sparks generated by electrical equipment). It is generally required that refrigerants are nonflammable and not explosive except when the quantities are below prescribed limits.
- Environmentally safe. Refrigerants should not affect or alter environmental conditions in any way. One important aspect of that requirement is that refrigerants should show high energetic efficiency. The lack thereof would lead to increased production of carbon dioxide at the power plant and thus contribute indirectly to the global warming process.
- Thermodynamic requirements. The thermodynamic properties of refrigerants have to fulfill certain criteria.

The overall goal is to achieve energy conversion efficiency and sufficient capacity.

Thus refrigerants must be safe locally and globally. To be locally means fluid be nontoxic and nonflammable and pose no danger of explosion. They must also not affect any construction materials. These criteria aim at safety during operation, manufacture, service, use and final disposal. To be safe globally means refrigerants should not affect the environment in a significantly negative way.

In order to meet these requirements, an increasing effort is made to use refrigerant mixtures. They offer the potential to be the best compromise for fluids that meet some of the thermodynamic requirements that are very important for the performance of the equipment and hopefully all the other requirements that determine feasibility in many different aspects. Refrigerant mixtures are gaining importance as the acceptable working fluid of future generations of equipment. However, the thermo-physical properties of mixtures are considerably more complex than those of pure fluids. It is the focus of this text to comprehensively present the characteristics of mixtures to the advanced student and practicing engineer.

## BACKGROUND OF ENVIRON METAL CONCERNS

### Impact of Ozone Depletion

Stratosphere ozone depletion and global warming threaten to become the dominant environmental issues. Chlorofluorocarbons (CFCs) and other ozone-depleting substances that leak from refrigeration and air-conditioning equipment migrate to the stratosphere and deplete the ozone layer. Current ozone depletion at mid-latitudes is estimated is approximately 5 %. Ozone depletion harms living creatures on Earth, increases the incidence of skin cancer and cataracts and poses risks to the human immune system. A sustained 1 % decrease in stratospheric ozone will result in approximately a 2 % increase in the incidence of fatal non-melanoma skin cancer based on a United Nations Environment Program Study. The U.S. Environmental Protection Agency (EPA) expects 295 million fewer cases of non-melanoma skin cancer over inthis century with a successful phase-out of CFCs.

### Impact of Global Warning

The antropogenic use of energy has been adding gases to the atmosphere that trap heat radiation and warm the earth, known as "greenhouse gases". In 1995, the Intergovernmental Panel on Climate Change (IPCC) reported that the biosphere has already warmed about 0,6 °C over the last century due to a discemible human influence on a global climate. The temperature rise of this magnitude will change local and global climates, temperature and precipitation patterns induce a sea level rise and alter the distribution of fresh water supplies. The impact on our health by global warming is likely to be significant.

There are two types of global warming contribution through refrigeration and air-conditioning systems. The first one is the direct global warming potential (DGWP) due to emission of refrigerants and their interaction with heat radiation. The second is the indirect global warming potential (IDGWP) due to the energy that is generated through the combustion of fossil fuels. The combined effect of these two global warming contributions is called the total equivalent warming impact (TEWI). (Fish et al. 1991).

### International Efforts on Environmental Protection

Concern over the potential environmental impacts of ozone depletion led to the development of an international agreement, the Montreal Protocol, to reduce the production of ozone-depleting substances such as CFCs, hydro chlorofluorocarbons (HCFCs) and halons. After the Montreal Protocol was signed in 1987, the regulation was extended in a follow up conference. At the fourth meeting of the parties to the Montreal Protocol in November 1992, new controls were required to phase out CFCs by the end 1995 and HCFS by 2030 (Table 1, Reed, 1993). Now the regulation of HCFC is being tightened with a fasten schedule and some countries already have more severe regulation plans. In the United States, the phase out of R22 in new machinery is set for the year 2010 (Allied Signal Chemicals, 1999) and in Germany it was set for January 1, 2000 (Kruse, 1993) [19]. In 1997, the Parties to the United Nations Framework Convention on climate change agreed to an historic Kyoto Protocol to reduce greenhouse gas emissions and set emission reduction targets for developed nations: 8 % below 1990 emissions levels for the European Union, 7 % for the United States and 6 % for Japan. Emission reduction targets include hydro fluorocarbons (HFCs) that are some of the alternative refrigerants introduced as a response to ozone depletion.

**Table 1.** HCFCs, Regulation Schedule

Jan 1, 1996	2004	2010	2015	2020	2030
Freeze	35 %	65 %	90 %	99,5 %	100 %
Consumtion	reduction	reduction	reduction	reduction	reduction

## Impact of Environmental Issues on U.S. climate

### Control industry

The Montreal Protocol and Kyoto Protocol forced the climate control industry to change refrigerants in the U.S., the clean Air Act Amendments of 1990 based on the Montreal Protocol forced the climate control industry to change to use of CFCs to HFCs. However, the European Union encourages the use of natural refrigerants such as hydrocarbons and carbon dioxide. Therefore, the search for the alternative refrigerants is still wide open but has to be completed in a limited time to satisfy these two protocols.

### Mixtures as R22 Replacements

R22 is widely used in the air conditioning and heat pump industry, especially in residential unitary and air-conditioning systems. The phase out of R22 requires manufacturers to find suitable alternatives in a relatively short time frame. In 1991, the Air-conditioning and Refrigeration Institute (ARI) started the R22. Alternative Refrigerant Evaluation Program (AREP) to find and evaluate promising alternative to the refrigerants R22 and R502 for products such as unitary air-conditioners, heat pumps, chillers, refrigeration equipment and ice-making machines (Godwin, 1933). [15] This test program involved researches worldwide and shared experimental results Alternative refrigerants were sought to satisfy the following requirements, environmentally benign (zero ODP), nonflammable and similar system level behavior (equivalent performance minimum hardware changes). Currently there is no acceptable pure fluid replacement that satisfies all these requirements. Alternatively, the mixing of these refrigerants was suggested to fulfill the desired requirements.

## REFERENCES

- [1] Allied Signal Chemicals, 1999, Genetron AZ-20 Product Brochure.
- [2] ASHRAE, handbook of Fundamentals, 1993, Chapter 16, American Society of Heating, Refrigerating, and Air-Conditioning Engineers, pp. 2-6.
- [3] Calm, J.M., 1993, "Comparative Global Warming Impacts of Electric Vapor-Compression and Direct-Fired Absorption Equipment", Report TR-103297, Electric Power Research Institute (EPRI), Palo Alto, CA.
- [4] Calm, J.M., 1994, "Refrigerant Safety", ASHRAE Journal, Vol. 36, No. 7, pp. 17-26.
- [5] Calm, J.M. and D.A. Didion, 1997, "Trade-Offs in Refrigerant Selections: Past, Present, Future", International Journal of Refrigeration, Vol. 21, No. 5, pp.6-19.
- [6] Carrier, W.H. and R.W. Waterfill, 1924, "Comparison of Thermodynamic Characteristics of Various Refrigerating Fluids", Refrigerating Engineering.
- [7] CLPC (Car Lighting and Power Company), 1922, Ice and Refrigeration, Advertisement, Nov., p. 28.
- [8] Corr, S., J.D. Morrison, F.T. Murphy and R.L. Powell, 1995, "Developing the hydrofluorocarbon range: Fluids for centrifugal compressors", Proceedings of the 19<sup>th</sup> International Congress of Refrigeration, Paris, France: International Institute of Refrigeration (IIR), Iva, pp. 31-138.
- [9] Domanski, P., 1997, "Theoretical Evaluation of the Vapor Compression Cycle With a Liquid-Line/Suction-Line Heat Exchanger, Economizer, and Ejector", NISTIR 5606, The National Institute of Standards and Technology, Gaithersburg, MD.
- [10] Downing, R.C., 1966, "History of the organic fluorine industry", Kirk-Othmer Encyclopedia of Chemical Technology (2<sup>nd</sup> edition). New York, NY: John Wiley & Sons, Incorporated, Vol. 9, pp. 704-707.
- [11] Downing, R.C., 1984, "Development of chlorofluorocarbon refrigerants", ASHRAE Transactions. Atlanta, GA: American Society of Heating, Refrigerating, and Air-Conditioning Engineers (ASHRAE), Vol. 90, Pt. 2B, pp. 481-491.

- [12] DuPont Fluorochemicals, 2000, "Technical Information for Suva Refrigerants", <http://www.dupont.com/suva>, Wilmington, DE.
- [13] Evans, O., 1805, *The Abortion of a Young Steam Engineer's Guide*, Philadelphia, PA.
- [14] Fischer, S.K., J.J. Tomlinson and P.J. Hughes, 1994, "Energy and Global Warming Impacts of Not-In-Kind and Next Generation CFC and HCFC Alternative", Alternative Fluorocarbons Environmental Acceptability Study (AFEAS) and U.S. Department of Energy (DOE).
- [15] Godwin, D., 1993. "Results of System Drop-In Test in ARI's R-22 Alternative Refrigerants Evaluation Program, Arlington, VA:ARI"
- [16] Houghton, L.G. et al, 1995, "Climate Change 1994", Radiative Forcing of Climate Change and an Evaluation of the IPCC IS92 Emissions Scenarios, Cambridge University Press.
- [17] Ingels, M., 1952, Willis Haviland Carrier – Father of Air Conditioning. Syracuse, NY: Carrier Corporation.
- [18] Intergovernmental Panel on Climate Change (IPCC), 1996, "Climate Change 1995 – Contribution of Working Group I to the Second Assessment Report of the Intergovernmental Panel on Climate Change", edited by J.T. Houghton, L.G. Meira Filho, B.A. Callander, N. Harris, A. Kattenberg and K. Maskell. Cambridge, UK: Cambridge University Press.
- [19] Kruse, H., 1993, "European research and Development Concerning CFC and HCFC Substitution", Proceeding of ASHRAE/NIST Refrigerants Conference, Gaithersburg, MD, pp. 41-57.
- [20] McLinden, M.O. and D.A. Didion, 1987, "Quest for alternatives", ASHRAE Journal, Vol. 29, No. 12, pp. 32-36, 38, 40 and 42.
- [21] McLinden, M.O., 1988, "Thermodynamic Evaluation of Refrigerants in the Vapor Compression Cycle Using Reduced Properties", International journal Refrigeration, Vol. 11, No, 3, pp. 134-143.
- [22] McLinden, M., S.A. Klein, E.K. Lemmon and A.P. Perkin, 1998, "Thermodynamic and Transport Properties of Refrigerants and Refrigerant Mixtures", NIST Database 23: NIST REFPROP, Version 6.0, National Institute of Standards and Technology, Gaithersburg, MD.
- [23] Midgley, T., Jr. and A.L. Henne, 1930, "Organic fluorides as refrigerants", Industrial and Engineering Chemistry, Vol. 22, pp. 542-545.
- [24] Midgley, T., Jr., 1937, "From the periodic table to production", Industrial and Engineering Chemistry, Vol. 29, No. 2, pp. 239-244.
- [25] Perkins, J., 1834, Apparatus for Producing Ice and Cooling fluids, Patent No. 6662, United Kingdom.
- [26] Petterson, J., 1999, "Carbon Dioxide (CO<sub>2</sub>) as a Primary Refrigerant", Proceedings of the Centenary Conference of the Institute of Refrigeration, London, SW1H 9JJ.
- [27] Pictet, R., 1885, Aus Kohlensäure und schwefliger Säure bestehende Verflüchtigungsflüssigkeit für Kältemaschinen [A Volatile Liquid Comprising Carbon Dioxide and Sulfur Dioxide for Refrigeration Machines], Patent 33733 (Class 17, Ice Production and Storage), Germany: Kaiserliches Patentamp.
- [28] Pillis, J.W., 1993, "Expanding Ammonia Usage in Air Conditioning", Proceedings of the ASHRAE/NIST Refrigerants Conference: R-22/R-502 Alternatives, American Society of Heating, Refrigerating, and Air Conditioning Engineers, Atlanta, GA, pp. 103-108.
- [29] Reed, J.W., 1993, "Environmental Overview: CFC and HCFC regulatory Update", Proceedings of the 4<sup>th</sup> IEA Heat Pump Conference, Maastricht, the Netherlands, pp.11-19.
- [30] Richard, R.G. and I.R. Shankland, 1992, "Flammability of alternative refrigerants", ASHRAE Journal, Vol. 34, No. 4, pp. 20 and 22-24, April.
- [31] Sand, J.R., S.K. Fischer and V.D. Baxter, 1997, "Energy and Global Warming Impacts of HFC Refrigerants and Emerging Technologies", Alternative Fluorocarbons Environmental Acceptability Study (AFEAS) and U.S. Department of Energy (DOE).
- [32] Thevenot, R., 1979, *A History of Refrigeration throughout the World*, Translated from French by J.C. Fidler. Paris, France: International Institute of Refrigeration.
- [33] UNEP, 1996, *Handbook for the Montreal Protocol on Substances That Deplete the Ozone Layer* (4<sup>th</sup> edition), Nairobi, Kenya: United Nations Environment Programme (UNEP) Ozone Secretariat.

## SUMMARY OF THE USING SOLAR ENERGY ON THE GLOBAL LEVEL AND IN THE REPUBLIC OF SERBIA

**Bojana Opačić, Dragan Čočkalo, Jasmina Pekez**

University of Novi Sad, Technical faculty "Mihajlo Pupin" Zrenjanin, Serbia

e-mail: [opacic\\_bojana@yahoo.com](mailto:opacic_bojana@yahoo.com)

**Abstract:** This work shows an overview on current renewable energy resources, paying special attention to solar energy. Also, an overview of perspective for the further development of their usage has been given. Global potentials have been analyzed in the area of renewable energy resources as well as available potentials in the Republic of Serbia. During the last years, the usage of the renewable energy resources has been increased so that the Europe Union Directive 2009/28/EC foresees the increase of renewable energy resources' participation in the total energy consumption until 2020. year up to 20%. Technically utilized energy potential of the renewable energy resources (OIE) in the Republic of Serbia is very significant and estimated on over 6 million tons equivalent of oil (ten) annually. However, the renewable energy resources' participation in the total energy balance, excluding big power plants as well as biomass, has still been on a low scale. The usage of renewable energy resources is one of the key components of sustainable development which provides rational economic, ecological and social effects.

**Key words:** renewable energy resources, solar energy, production, energy fuel.

### INTRODUCTION

The term of renewable energy resources refers to the energy resources which could be found in the nature and are renewable completely or partly and these are as follows: solar energy, waterflow and wind energy, biomass, geothermal energy and etc.

Renewable energy resources are used for the production with about 1% of energy production in total in the world. Development of the renewable energy resources, in particular solar, water and wind energy and biomass – is the main aim of the energy politics of European Commission – European Commission department for energy and transport. Europe Union has brought several directives which refer to the renewable energy resources: Directives 2001/77/EC, 2003/30/EC and 2009/28/EC. In the last directive, it is foreseen that until the year of 2020. the renewable energy resources participate with at least 20% of total energy consumption in the Europe Union. This directive also foresees that until the year of 2020. the usage of the renewable energy in transport (biogas, electric energy and hydrogen produced out of the renewable resources) will be at least 20% of total fuel consumption in the Europe Union [7].

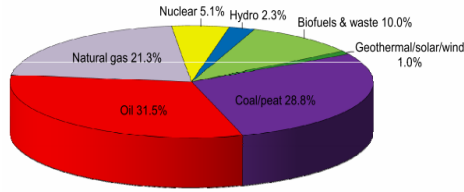
The Republic of Serbia has adopted numerous documents in the area of the renewable energy resources and created the favourable conditions for a significant increase of production and consumption of these energy resources but the energy production from the renewable energy resources has still been insufficient. The usage of the renewable energy resources in Serbia is very important due to the scarce potential of conventional energy resources. Furthermore, the usage of these resources contributes to even more efficient usage of own potential in energy production which is important in decrease of the emission of "gases of the green garden effects", decrease of fossil fuel import, development of the local industry, especially in rural areas and opening of new working post. Solar energy is a form of energy with the biggest potential.

Solar energy presents an inexhaustible ecological energy resource whose global potential multifunctionally undergoes the world's needs for the electricity.

### AVAILABLE POTENTIAL OF RENEWABLE ENERGY

#### Global production

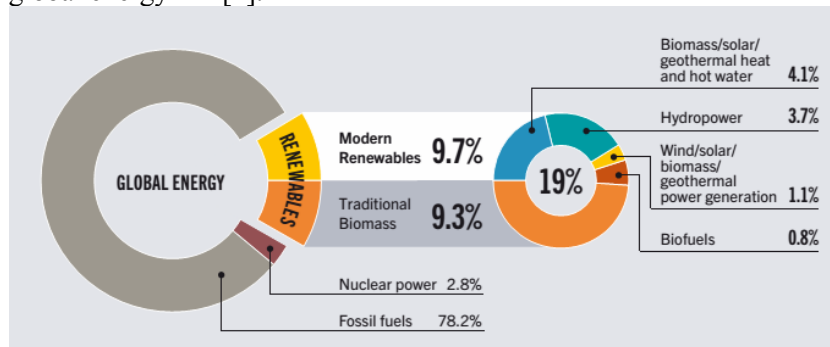
The most important energy of 20. century was oil. In the world's primary energy consumption oil has participated with about 31.5%, coal with about 28.8%, gas with about 21.3%, renewable energy with about 13.3% and nuclear energy with about 5.1% (See Figure 1.) [1].



13 113 Mtoe

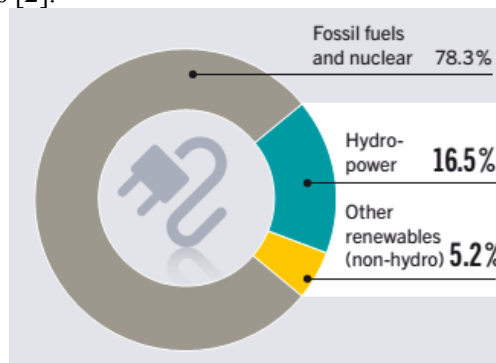
**Figure 1.** Share of total primary energy supply in 2011. - Source: IAE, 2013.

Global demand for renewable energy continued to rise during 2011 and 2012, despite the international economic crisis, ongoing trade disputes, and policy uncertainty and declining support in some key markets. Renewable energy supplied an estimated 19% of global final energy consumption by the end of 2011, the latest year for which data are available. Of this total, approximately 9.3% came from traditional biomass, which is used primarily for cooking and heating in rural areas of developing countries. Useful heat energy from modern renewable sources accounted for an estimated 4.1% of total final energy use; hydropower made up about 3.7%; and an estimated 1.9% was provided by power from wind, solar, geothermal, and biomass, and by biofuels (See Figure 2.) Renewables are a vital part of the global energy mix[2].



**Figure 2.** Estimated renewable energy share of global final energy consumption 2011. Source: GLOBAL REPORT, 2013.

Renewables have accounted for an ever-growing share of electric capacity added worldwide each year, and in 2012 they made up just over half of net additions to electric generating capacity. By year's end, renewables comprised more than 26% of total global power generating capacity and supplied an estimated 21.7% of global electricity, with 16.5% of total electricity provided by hydropower (See Figure 3.) While renewable capacity rises at a rapid rate from year to year, renewable energy's share of total generation is increasing more slowly because many countries continue to add significant fossil fuel capacity, and much of the renewable capacity being added (wind and solar energy) operates at relatively low capacity factors [2].



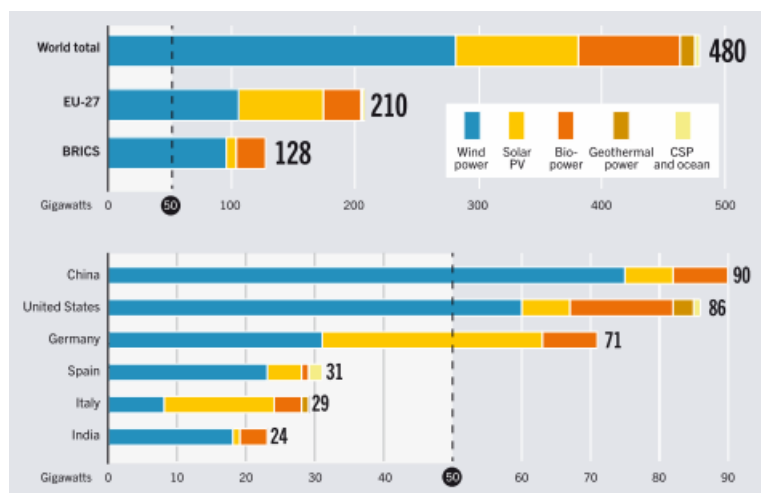
**Figure 3.** Estimated renewable energy share of global electricity production end 2012. - Source: GLOBAL REPORT, 2013.

During the five-year period 2008–2012, installed capacity of many renewable energy technologies grew very rapidly, with the fastest growth in the power sector. Total capacity of solar photovoltaics (PV) grew at rates averaging 60% annually (See Figure 4). Solar PV experienced continued price reductions in 2012 due to economies of scale and technology advances, but also due to a production surplus of modules. Combined with the international economic crisis (which has helped drive policy changes) and ongoing tensions in international trade, these developments have created new challenges for some renewable energy industries and, particularly, equipment manufacturers[2].

		2010	2011	2012
Investment in new renewable capacity (annual) <sup>1</sup>	billion USD	227	279	244
Renewable power capacity (total, not including hydro)	GW	315	395	480
Renewable power capacity (total, including hydro)	GW	1,250	1,355	1,470
Hydropower capacity (total) <sup>2</sup>	GW	935	960	990
Bio-power generation	GWh	313	335	350
Solar PV capacity (total)	GW	40	71	100
Concentrating solar thermal power (total)	GW	1.1	1.6	2.5
Wind power capacity (total)	GW	198	238	283
Solar hot water capacity (total) <sup>3</sup>	GW <sub>th</sub>	195	223	255
Ethanol production (annual)	billion litres	85.0	84.2	83.1
Biodiesel production (annual)	billion litres	18.5	22.4	22.5

Figure 4. Average annual growth rates of renewable energy capacity - Source: GLOBAL REPORT, 2013

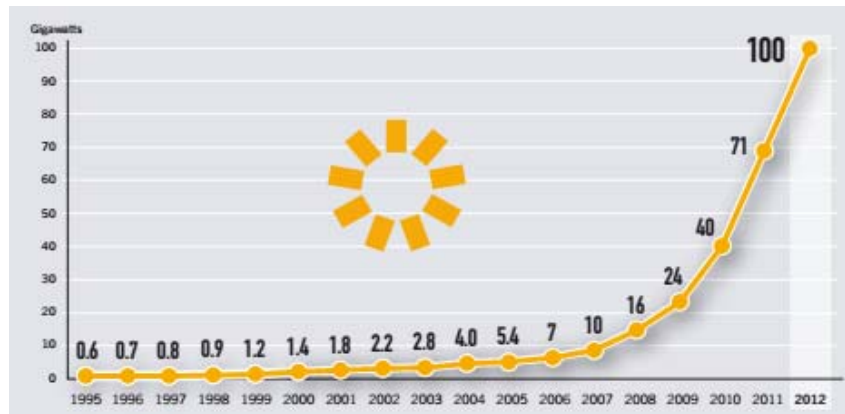
Total renewable power capacity worldwide exceeded 1,470 gigawatts (GW) in 2012, up about 8.5% from 2011. Hydropower rose to an estimated 990 GW, while other renewables grew 21.5% to exceed 480 GW. Globally, wind power accounted for about 39% of renewable power capacity added in 2012, followed by hydropower and solar PV, each accounting for approximately 26% (See Figure 5). Solar PV capacity reached the 100 GW milestone to pass bio-power and become the third largest renewable technology in terms of capacity (but not generation), after hydro and wind. [1].



Slika 5. Renewable energy capacities – source: GLOBAL REPORT, 2013

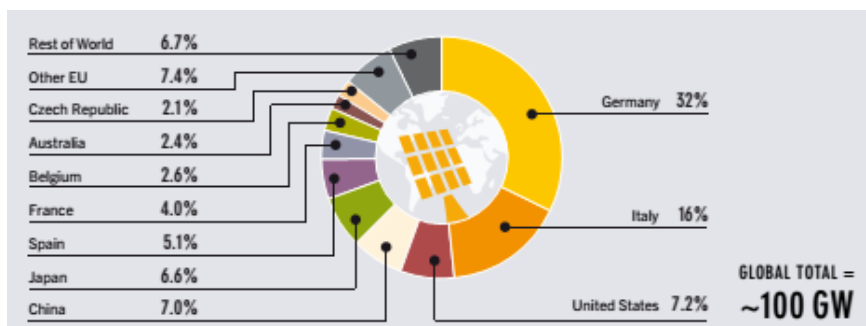
The solar photovoltaic (PV) market saw another strong year, with total global operating capacity reaching the 100 GW milestone in 2012. The market was fairly stable relative to 2011, with slightly less capacity brought on line but likely higher shipment levels, and the more than 29.4 GW added represented nearly one-third of total global capacity in operation at year's end. 2 (See Figure 6) [1].





**Figure 6.** Solar PV global capacity, 1995 - 2012. – source: GLOBAL REPORT, 2013

Eight countries added more than 1 GW of solar PV to their grids in 2012, and the distribution of new installations continued to broaden. The top markets are Germany, Italy, China, the United States, and Japan were also the leaders for total capacity. By year's end, eight countries in Europe, three in Asia, the United States, and Australia had at least 1 GW of total capacity. The leaders for solar PV per inhabitant were Germany, Italy, Belgium, the Czech Republic, Greece, and Australia (See Figure 7). Europe again dominated the market, adding 16.9 GW and accounting for about 57% of newly installed capacity, to end 2012 with 70 GW in operation. For the second year running the EU installed more PV than any other electricity-generating technology: PV represented about 37% of all new capacity in 2012. [1].



**Figure 7.** Solar PV global capacity, shares of top 10 countries – source: GLOBAL REPORT, 2013

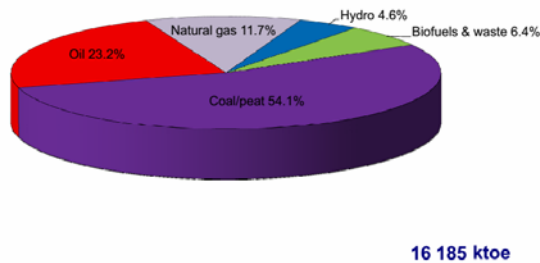
The number and scale of large PV projects continues to increase. By early 2013, about 90 plants in operation were larger than 30 MW, and some 400 had at least 10 MW of capacity. The world's 50 biggest plants reached cumulative capacity exceeding 4 GW by the end of 2012, and at least 12 countries across Europe, North America, and Asia had solar PV plants over 30 MW. More than 20 of these facilities came on line in 2012, including the world's two largest: a 250 MW thin film plant in the U.S. state of Arizona and a 214 MW plant in Gujarat, India. Germany held on to its lead for total capacity of facilities larger than 30 MW, with a cumulative 1.55 GW in operation by year's end, followed by the United States, France, India, Ukraine, China, and Italy. Several projects are planned around the world that range from 50 to 1,000 MW in scale [1].

Solar PV is starting to play a substantial role in electricity generation in some countries, meeting an estimated 5.6% of national electricity demand in Italy and about 5% in Germany in 2012, with far higher shares in both countries during sunny months. By year's end, PV capacity in the EU was enough to meet an estimated 2.6% of total consumption, and global capacity in operation was enough to produce at least 110 TWh of electricity per year [1].

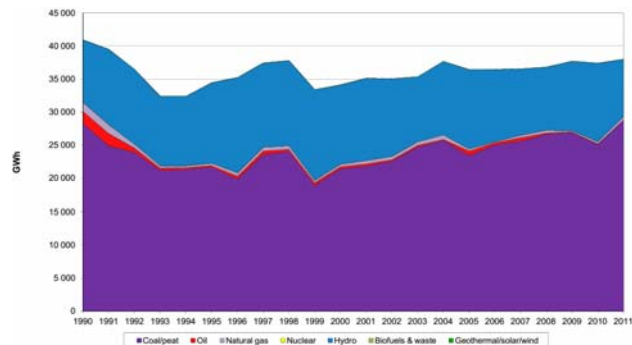
## 2.2. Available potential of renewable energy in the Republic of Serbia

In the Serbia's primary energy consumption oil has participated with about 23.2%, coal with about 54.1%, gas with about 11.7% and renewable energy with about 11% (See Figure 8.) [5].

In Figure 9, shows the shares of different energy sources in electricity production in Serbia. The diagram shows that around two-thirds of electricity generation from fossil fuels, ie. coal, while other sources significantly represented hydro (with a share of 21.2%), mainly due to conventional large hydro [5].



**Figure 8.** Share of total primary energy supply in 2011. - Source: IAE, 2013.



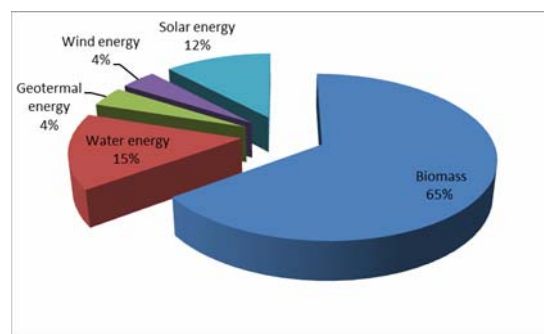
**Figure 9.** Estimated renewable energy share of global electricity production end 2012. - Source: IAE, 2013.

As far as exploitation of renewable energy sources in the Republic of Serbia is considered, these sources are widely underutilized although having a substantial potential. This is particularly true if water energy conversion is excluded. Some estimates show that total renewable energy sources technically available for exploitation are approximately 6 Mtoe annually. For electrical energy conversion however, the major potential lies with wind, solar and water energy conversion [4].

Renewable energy structure in Republic of Serbia:

- Biomass 3.3 Mtoe - 65% of total potential;
- Water energy 1.7 Mtoe - 15% of total potential;
- Geothermal energy 0.2 Mtoe - 4% of total potential;
- Wind energy 0.2 Mtoe - 4% of total potential;
- Solar energy 0.6 Mtoe - 12% of total potential;

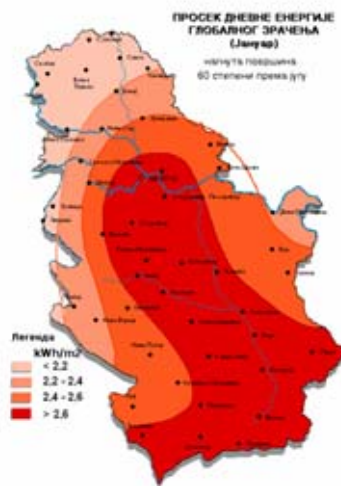
The Republic of Serbia of all available technical potential of renewable energy is already using 33% (0.9 Mtoe of used water potential and 1.06 Mtoe of the potential of biomass), See Figure 10 [3].



**Figure 10.** Renewable energy structure in Republic of Serbia – Source: National aims and plan of the Republic of Serbia's

The republic of Serbia has a significant solar potential. With the solar irradiation ranging from the average of 1.1–1.7 kWh/m<sup>2</sup>/day during January to 5.9 - 6.6 kWh/m<sup>2</sup>/day during July on a horizontal plane, the Republic of Serbia has the basic element for solar power utilization. Considering the facts shown above, the irradiation on a horizontal plane of 1200 kWh/m<sup>2</sup>/year (for northwest regions) and 1550 kWh/m<sup>2</sup>/year (for south regions) can be expected.

These data can be further optimized by using planes at an elevation angle or solar tracking plane (positioning to the sun path). This means that optimizing the photovoltaic plane positioning and angles enables from 1560 kWh/m<sup>2</sup> /year up to 2000 kWh/m<sup>2</sup>/year irradiation in the Republic of Serbia depending on the location (See Figure 11 and 12) [4].



**Figure 11.** Average daily energy irradiation on January, on a 60deg, kWh/m<sup>2</sup>



**Figure 12.** Annual average daily energy irradiation on a horizontal plane, kWh/m<sup>2</sup>

According to relevant international institution data, the Republic of Serbia has substantial solar energy potentials. By establishing legal and technical regulations, as well as sublegal acts considering enhanced pricings, foundations for investments in the area of renewable power sources were created. A constant decrease in technology prices and a relatively high price of energy generated using photovoltaic systems are making photovoltaic systems attractive for investment.

### NATIONAL STRATEGY AND ENVIRONMENTAL ASPECTS OF THE USING OF RENEWABLE ENERGY

Serbia's energy import dependence in 2010. year was about 33,6 %. In the future, the most important it would be to provide secure, high quality and reliable supply of energy and substances and to decrease energy dependence of the country [4].

Reserves of fossil substances, as oil and gas, are very scarce (less than 1% of the total amount of energent reserves in Serbia), and the biggest reserves are in the low quality lignites (about 92% in the total balance of reserves) [4].

National aims and plan of the Republic of Serbia's renewable energy resources usage have been determined within the Law of Energetics. The aims are established according to the energy needs, economic possibilities and obligations of the Republic of Serbia taken over according to the ratified international agreements. [4].

Ratification of the Contract regarding the energy union founding, Serbia has accepted the obligation to bring and pass the plan of application of the directive 2001/77/EC about promoting the production of electricity from OIE and directive 2003/30/EC about promoting the biogas usage and other fuels in the transort sector [6].

Development of the pure, efficient and safe energy supply, promotion of the energy usage method which pollutes less the environment, managing the natural resources and creating industries, services and societies that influence less on the environment – all these are important investments in the future. Since the environment pollution recognizes no limits, fight for the environment and preserving the environment, actually is the fight for the whole continent, but not the fight for the whole planet.

In the process of joining the Europe Union, the electroenergetic sector of the Republic of Serbia will also meet the obligatory and additional financial costs of the emission of CO<sub>2</sub>. At this moment, the Republic of Serbia as a developing country, has no international obligation of decreasing gas emission with the effect of green garden (GHG), but in the moment of joining the EU membership, it will probably be obligatory to limit, i.e. to decrease the emission of the green garden gases.

Working on the structure change of energents for the production of electricity, i.e. significant increase of participation of renewable energy resources which will bring to much lower specific emission of the green garden gases.

## CONCLUSION

In the future, global society development will greatly depend on the condition in which the area of energetics is. Problems that all countries in the world more or less confront with are connected to energy providing and preserving the environment. Explosion of human population on the Earth causes constant increase of energy needs, especially electricity demand. The trend of needs' increase on the global level is about 2,8 % annually [5]. On the other hand, the current structure of the primary resources of electricity cannot provide, on the global level, such a trend of electricity production increase. The reason for this are current eco problems directly caused by fossil combustion and nuclear fuels, on which is based current electricity production in the world. Beside that, existing dynamics according to which the fossil fuels have been exploited, will in the near future also bring to the exhaustion of its resources.

Direct consequence of these contradictory conditions of production and consumption is the constant increase of electricity cost, with which, even on the present level, is being created ecological and economical justified needs of including alternative resources in the global strategy of energetics' development. These energetic flows forced very developed countries to invest huge capital and hire many professionals in the development of the system for using renewable resources of electricity (solar power stations, wind power stations, biomass and biogas power stations, geothermal power stations). As a result of such investments, the technology has been adopted as well as industry for the technical reliable conversion of some primary renewable resources. Beside that, international protocols and obligations regarding the CO<sub>2</sub> emission decrease (Kyoto protocol) and local eco problems, forced the Governments of many countries to motivate, with different subsidies, building of eco pure power plants which use renewable resources. This kind of politics has brought to exceptional popularization and fantastic trend of increasing participation of certain renewable resources in the total production of electricity. Rapid increase of the photo potential industry in the world with the growth of production capacity and favourable political climate in countries such as Germany, Spain, Japan, China, Italy, Korea, Greece, etc. promise bright perspective of photo potential technology in Serbia as well. However, photo potential industry requires favourable and stable political conditions for constant and sustainable development. Rapid and rashly changes in conditions and amount of subventions and political attitudes could bring into question positive developing trend. Taking into consideration the present importance of photopotential technologies, their long term potentials and time needed for these technologies to develop, the development and application of these technologies completely justify and encourage state support and subventions. Apart from this, the photopotential industry can highly contribute to economy of a country by opening new working posts as well as causing the development of small and medium companies.

## REFERENCE

- [1] \*\*\* : REN21, Renewables 2007 - 2012: Global Status Report, [http:// www.ren21.net/](http://www.ren21.net/)
- [2] \*\*\* : REN21, Renewables 2013: Global Status Report, [http:// www.ren21.net/](http://www.ren21.net/)
- [3] \*\*\* : Energy balance of the Republic of Serbia for year 2012., <http://www.merz.gov.rs/lat/dokumenti/energetski-bilans-republike-srbije-za-2012-godinu>.
- [4] <http://www.merz.gov.rs/lat>
- [5] <http://www.iea.org/>
- [6] Government of the Republic of Serbia: Law on Energy, Sluzbeni Glasnik RS No. 84/2004.
- [7] Government of the Republic of Serbia: Law on Ratification of the Treaty establishing the Energy Community between the European Community and the Republic of Albania, Bulgaria, Bosnia and Herzegovina, Croatia, the former Yugoslav Republic of Macedonia, Montenegro, Romania, Serbia and the United Nations Interim Mission in Kosovo in accordance with Resolution 1244 United Nations Security Council, Fig. Gazette of RS ", no. No. 62/2006.

## SUSTAINABILITY ANALYSIS OF RECYCLING OF MOTOR VEHICLES IN SERBIA AND OPTIMUM TECHNOLOGY REVIEW

**Dragiša Tolmač, Jasna Tolmač, Slavica Prvulović, Milan Pavlović**  
University of Novi Sad, Technical faculty "Mihajlo Pupin", Zrenjanin.  
e-mail: [dragisatolmac@gmail.com](mailto:dragisatolmac@gmail.com)

**Abstract:** Recycling of cars includes a variety of processes (manual separation, shredding and physical separation methods) that enable you to obtain the final product, floricane materials (metals, plastics, rubber, glass,.) Suitable for the production of new material goods. Using recycled materials saves natural resources and saves energy. Recycling creates less air and water pollution than primary production of raw materials. In the paper discusses problems of recycling of motor vehicles at the end of the life cycle. The analysis of the sustainability of recycling of motor vehicles, and give an overview of optimal technology. In recent years in Serbia, there is a need to build a network of dismantling and recycling of vehicles at the end of life vehicles (ELV). The reasons for this are the sustainability industry, environmental protection, harmonization of legislation with the EU, and so on.

**Keywords:** Recycling, Automobiles, Sustainability Analysis.

### INTRODUCTION

Motor vehicle recycling of end of life (ELV) in developed countries is regulated process that led to the development of new industries. It has multiple effects related to environmental protection, sustainable use of natural resources, energy saving, labor intensive employment, improving economic performance and the achievement of a substantial profit, and the realization of sustainable development of the entire automotive industry. The actual condition of recycling of motor vehicles in Serbia is far from the situation in developed countries. To overcome this problem in the framework of technological development, we developed a model of integrated and sustainable recycling ELV, which defines a network of centers for the collection and removal, as well as a network of centers for the recycling of materials and substances that are extracted from waste motor vehicles. This model is made in accordance with the requirements of EU directives relating to the ELV. In this way, the model is expected to offer solutions for the recycling of 95% by weight of ELV 2015th and that provide significant employment growth in the recycling of motor vehicles [15]. Huge amounts of automotive scrap today a major issue in all countries of the world. With the problem facing our state.

It is estimated that in the Republic of Serbia is currently in use around 1.6 million units, with an average age between 16 and 17 years. Serbia will soon face the problems and the amount of approximately 1.6 million tons of waste materials of various kinds, among which there are hazardous substances. Generation of automotive waste is successively through the dynamic renewal of the fleet and of course the generation of waste in the mining car maintenance. In any case, this is a very large amount of waste utilization which would optimally be designed. The current situation in Serbia is characterized by a lack of organization in the recycling of metals with the exception of the collection and recycling of its initial (selection, cutting and crushing). Unfortunately, all hazardous materials, plastic parts, rubber and other non-metal parts are not treated the same and are left to waste or green spaces [11, 12].

### ANALYSIS OF RELEVANT KNOWLEDGE

Energy consumption for the production of secondary raw materials from the recycling process produced significantly lower than those used to obtain material from mining primary production [7], [21]. Recycling of used motor vehicles (ELV) in high-income countries is very successful, especially after the introduction of the shredder in the recycling process of used cars. The rate of recycling in developed countries more than 90% of the used motor vehicles.

ELV recycling reduces the minerals from natural sources and generates a source of raw materials for the production of new products derived from recycled materials [9], [24]. In addition to the economic benefits of recycling system of used motor vehicles, is an important contribution to protect the environment. Removing environmentally harmful components and materials, specialty oils, brake fluid, antifreeze, air bags, mercury, freon and similar substances require special treatment and expertise in areas such waste dismantling. In Germany, Centers for dismantling vehicles covering a circle with a radius of 50 kilometers. There are around 1.4 million passenger cars and light commercial vehicles. The estimated number of annual waste produced 100,000 vehicles per year in Serbia, so that a larger number of equipped recycling operators. [14], [20].

Recycling of ELV, directly positive effect on the environment and energy use, and indeed significantly improves the objective quality of life. On the other hand, by ensuring sustainable use of natural resources to secure quality of life for future generations, which is an essential condition for the survival of human society [11, 12].

Recycling of used motor vehicles in the world, is an efficient process which recycles more than 75% of the cars, along with the rate of used cars collected by 95%. In the United States, is recycled about 11 million units, representing a \$ 5 billion of revenue. Automobile Recycling Industry in the United States employs more than 40,000 employees in more than 7,000 companies. In the EU, the number of recycled car reaches 9 million per year, equivalent to 2.2 million tons of waste. As in the U.S., profit mainly by selling used parts and metal. Based on the data of the Statistical Office, the number of used cars in the Republic of Serbia, is approximately 100,000 per year.

Taking this estimate of the number of used cars in the Republic of Serbia, as well as the use of certain materials percentage per vehicle, obtained 68,000 tons of ferrous metals, nonferrous metals 6.000 tons, 8,000 tons of plastics and composites, 1,400 tons of fluids, 5,000 tons of rubber, glass, 3,500 tons, 1,000 tons Textiles, 1,000 tons of batteries, and 6,100 tons of other waste from the used car. In the Republic of Serbia, during the process - recycles 14% of used motor vehicles, because the capacity for industry remains underdeveloped. In the domestic market ELV recycling, demand for secondary raw materials is high, and the level of recycling of 14%, should increase to European levels by 75%. On the basis of the ELV recycling system, we need new investment of over 20 million, in several plants shredder and mobile Balir presses, and increase the efficiency of the Recycler [17, 18].

## **SUMMARY OF THE OPTIMUM TECHNOLOGY RECYCLING CARS**

There are no exact data on the quantities of waste generated by vehicles in one year. In Serbia, there are over a million vehicles whose average age is over 10 years. The collection and disposal of waste vehicles mostly depends on supply and demand. Parts with use value is extracted in smaller amount, depending on their age and condition of end. The automobile recycling facilities in the world it is possible to recycle about 80% by weight of the car. The process of recycling cars is complex because of the variety of materials that are part of the car. Middle-class car, on average, consists of 76% metal, plastic 8%, 4% rubber, fluid 6%, 3% glass and other materials 3% [28, 29]. Apply two car recycling technologies, which differ in the way of sorting the material that make up the car. The first technology is based on optical (manuelnoj) separation, and other technology uses multiple methods (grinding, gravity separation methods and special). A third possibility is that the whole car pressed in one piece, using mobile Balir presses [30, 31].

### **3.1. Methods of optical separation**

This technology is based on the fact that the optical method, ie. manually separated integral parts of the car (rubber, glass, plastic, etc.), and the metal parts are at the end. Then metal parts go to the press to decrease volume and to facilitate further transport. All parts are obtained by means of optical finished products (manual) separation, and as such they go for further processing. This technology is the dominant manual labor as expensive and slows down the procedure of recycling.

### 3.2. The combined method of separation

When combined method of separating the whole car crushed in the special impact crusher, and then grinding the resulting product is still treating some of the methods of separation that are applied in the treatment of primary resources (physical and special methods of concentration). The resulting products were ready-made products combined method of separation, and as such they go for further processing.

## RESULTS AND DISCUSSION

The originality of the project an integrated recycling system of motor vehicles at the end of the life cycle is reflected in the development of the first national information system based on WEB-technology base that aims to detect and monitor the motor vehicle during the entire life cycle of the time-out vehicles. In Serbia, so far no systematic not address this problem in solving environmental and social, and economic problems when it comes to preserving the natural resources of our country. The aim of the project is to localize potential waste motor vehicles in Serbia that can be recycled or used for energy. The most important thing is to determine the scope and structure of the permanent disposal of motor vehicles in Serbia, especially hazardous waste and suggest measures for their removal or safe storage [15, 16, 17].

Project [15], is predicted to form the corresponding centers disassembly of used motor vehicles by the respective regions. Partner in this project is the Zastava car factory, which provides data on the number of cars that would be reported as appropriate Zastava model currently has on the market. At the same time flag gives instructions on how to dismantle it easier to vehicles belonging to their program. The importance of the project for Serbia is great, because our country is quite deficient in terms of resources. If we know now about 120 thousand cars a year off, and thus are ready for the recycling process, the weight of every vehicle around 1 ton, of which about 70% feromagnetični materials, there are also non-ferrous metals, plastics, rubber; We can not imagine how it is stored resources.

With the development of science and technology is one for your needs created a large number of materials complex chemical composition. Such materials due to their complexity can degradenaturally or during their rezgradnje be considered infinite. Disposal of these materials furnished or illegal landfills leads to environmental pollution. The recycling of these materials, in addition to economic benefits, the man protecting the environment, resulting in a better and healthier life. Obtaining metals from recycling leads to saving power generation, such as: steel 74%, aluminum 95%, copper 85%, lead 65%. Getting metal recycling reduces water consumption by 40%, reduces water pollution by 76% and air pollution by 86%.

## CONCLUSION

Motor vehicle recycling of end of life, according to the proposed model is based on the principles of sustainable development [15]. The establishment of this model in Serbia, in addition to environmental and economic effects of providing a high level of employment, which is very important for social policy. Thus, the number of employees in the entire cycle of recycling of motor vehicles at the end of the life cycle varies from 6,000 to 20,000 employees.

Sure to be a factor in employment includes the gross national income per capita, because of the wealth of the country and the population depends on the size of the fleet, and thus the number of motor vehicles at the end of the life cycle in one year. In addition, the state remains in the recycling of motor vehicles offices and fully in accordance with the proposed model to develop new profitable industry [1], [25].

In each of the used motor vehicles pose a major problem for the environment, both in terms of volume of waste and the number of hazardous substances from which they are built. That was the main reason that developed countries adopt and implement adequate legal solutions which runs organized recycling of motor vehicles at the end of the life cycle. On the other hand develop models for managing waste generated by motor vehicles during the entire life cycle, which are based on the principles of sustainable development. Thus minimizing waste and maximizing recycling and reuse of materials parts and components and aggregates [11, 12].

Since the operators are to be deployed on the territory of Serbia, so that citizens in their old cars can be submitted at the nearest recycling center which will be issued and a receipt which can be realized certain benefits when purchasing a new car. In this way, the action will involve all those involved in the recycling of batteries, waste oil, antifreeze, glass, plastic and everything that makes a car, and it is necessary to invest a total of over 20 million Euros. [20], [22, 23]. Metals and energy consumption in the world has a great trend.

### Acknowledgements

The results presented in this paper derive from the work on the project "Sustainable Development of technologies and equipment for the recycling of motor vehicles" under document number TR 35033th This project is funded by the Ministry of Education, Science and Technological Development of Republic of Serbia.

### REFERENCES

- [1] Arsovski, S., Milivojevic, J., Grubor, S., Kokic Arsic, A., Tonic, N., The influence of models of integrated and sustainable recycling of motor vehicles at the end of the life cycle of the level of employment in Serbia, Quality, No. 11-12 , 2010.
- [2] Afgan, N.H., Hovanov, N., Andre, P.M., Sustainable Management Organization With Example of Passenger Car Sustainability Assessment, International Journal for Quality Research, Vol. 3, 2009, No. 2.
- [3] Aleksić, A., Arsovski, S., Tonić, N., Grubor, S., Resilience of elv dismantling centres, Nacionalna konferencija o kvalitetu – FQ 2011, str.105-111.
- [4] Creation of a Sustainable Automobile Society Through Environmentally Friendly Recycling, Nissan, april 2008. (<http://www.nissan-global.com>)
- [5] Car Recycling Europe, Toyota Motor Marketing Europe, Brussels, October 2002.
- [6] Hempfl, K., The commercialization of recyclable materials and recycling waste in Serbia, USAID, 2010.
- [7] Ilić, I., Recycling and recycling of secondary raw materials of non-ferrous metals, Bor, 2002.
- [8] Jovanović, Z., Haase H, Ziems, D., Developing Waste Management in the German-speaking countries and challenges for Serbia's EU membership ambitions, Ekolat `08, Soko Banja, 2008.
- [9] Kozić, A., Sudarević, D., Access to recycling of motor vehicles, the Association for Quality and Standardization of Serbia, The quality of Festival 2005, 32. National Conference on Quality, Kragujevac, 19-21. May 2005<sup>th</sup>
- [10] Krstić, M., Marjanovic Z, Brzaković, R., Managing the lifecycle emission vehicles, the Association for Quality and Standardization of Serbia, The quality of Festival 2007, second National conference on quality of life, Kragujevac, 8-11. May 2007<sup>th</sup>
- [11] Milivojević, J., Grubor, S., Simon, A., Development of an integrated and sustainable recycling system of motor vehicles at the end of the life cycle of Serbia, 3. National conference on quality of life, quality Festival, 2008, Kragujevac
- [12] Milivojević, J., Grubor, S., Simon, A., Sustainable integrated system of recycling of motor vehicles during the life cycle, the First National Conference on recycling vehicles 2009<sup>th</sup>, Eck, 06 November, 2009. Milivojević, J., Bian, S., Djordjevic, M., Access to the assessment of the existing recycling system of motor vehicles at the end of the life cycle of Serbia, Faculty of Mechanical Engineering Kragujevac, Zastava vehicles, Kragujevac, 2010.
- [13] Junbeum, K., Junghan, B., Braden A., Recycling Systems and Management of Endof-Life Vehicles (ELVs), A Center for Sustainable Engineering Education Module, October 23, 2007.
- [14] Pavlović, M., Tolmač, D., et al., Sustainable development of technologies and equipment for the recycling of motor vehicles, the Ministry of Science and Technology RS. SRO: Technical Faculty "Mihajlo Pupin", Zrenjanin, (2011-2014.), No. Project: 035033rd.



- [15] Pavlović, M., Directions for the Development of Recycling of used cars in Serbia, the Association for the recycling of motor vehicles of Serbia, Belgrade, 2009.
- Pavlović, M., Subaru, N., Ecological logistics, Tehničkifakultet "Mihajlo Pupin", Zrenjanin, 2006.
- [16] Djukić, Dj., Recycling cars, Policy, 23 November 2009.
- [17] Djordjević, M., Kocic, M., Managing the preparation of a feasibility study of recycling of used materials cars, Project Management and Entrepreneurship, Proceedings, p. 72-76, Zlatibor, 9.-12.
- [18] Medić, D., Analysis of the economic potential of the used car market in Serbia, Technical Faculty "Mihajlo Pupin", Zrenjanin 2011
- [19] Krinke, S., Bosdorf Zimmer, B., Goldmann, D., Life Cycle Assessment of End-of-Life Vehicle Treatment, VOLKSWAGEN AG, June 2005.
- [20] Kozić, A., Sudarević, D., Access to the recycling of motor vehicles, FESTIVAL OF QUALITY, May 2005.
- [21] Gareth, C., Shahin, R., Cost models for increased value recovery from End-of-Life Vehicles, The centre for Sustainable Manufacturing And Reuse/recycling Technologies, Loughborough University, Wolfson School of Engineering, United Kingdom, PROCEEDINGS OF LCE 2006.
- [22] Tadić, D., Arsovski, S., Stefanovic, M., Aleksic, A., A Fuzzy AHP and topsis for ELV dismantling selection, International Journal for Quality Research, Vol. 4, 2010, No.2.
- [23] Toyota recycling & recovery technology: helping create a recycling- oriented society, Report compiled on July 3, 2003, Public Affairs Division, Toyota Motor Corporation.
- [24] Tolmač, D., Prvulović, S., Dimitrijević, D., Some aspects of recycling cars, I International Conference „ECOLOGY OF URBAN AREAS“ 2011, Proceedings, pp.127-131, ISBN 978-86-7672-145-0, Technical faculty “Mihajlo Pupin“, Zrenjanin, 30. 09. 2011.
- [25] Tolmač, D., Prvulović, S., Pavlović, M., Dimitrijević D., Basic elements of recycling tires, I International Conference - Process Technology And Environmental Protection (PTEP 2011), Proceedings, pp.90-95, Technical faculty “Mihajlo Pupin“, Zrenjanin, 2011.
- [26] Trumić, M., Čalić, N., Andrić, Lj., Ignjatović, M., Recycling Technologies and Sustainable Development, XIX Symposium on Mineral Processing, Oplenac, Serbia, 2004, pp. 257-265.
- [27] Trumić, M. Ž., Trumić, M. S., Marković, Z., Separation of ink particles from waste newspaper by deinking flotation, Journal of Mining and Metallurgy, 43A(2007) pp. 33-41.
- [28] Trumić, S. M., Trumić, Ž. M., Bogdanović, G., Marković, Z., Trumić, G., Deinking of recycled pulps using flotation and magnetic process, 12th Conference on Environment and Mineral Processing, VŠB-TU Ostrava, 5-7, June, Czech Republic, (2008), pp. 169-172.
- [29] Stojanović Dejan, Stojanović Dragan, Trumić Milan., Technologies of recycling cars, XII Scientific Symposium on natural resources and environmental protection, EKOIST 2004, Bor Lake, 30 May - 02 June, Serbia (2004), pp. 638 – 641.

## ENERGY AND EXERGY METHOD APPLIED ON SYSTEM OF HOT WATER BOILER

Milena Todorović, Dragoljub Živković, Marko Mančić, Pedja Milosavljević, Dragan Pavlović

University of Niš, Mechanical Engineering Faculty, Niš, Serbia  
e-mail: [milenatod1@yahoo.com](mailto:milenatod1@yahoo.com)

**Abstract:** Energy consumption is one of the most important indicator showing the development stages of countries and living standards of communities. Population increment, urbanization, industrializing and technologic development result directly in increasing energy consumption. This rapid growing trend brings the crucial environmental problems such as contamination and greenhouse effects. The problem of increasing energy consumption suggests that heating plants, i.e. hot water boilers as energy suppliers for household heating should be subjected to more detailed analysis. Most heating plants are designed by the energetic performance criteria based on first law of thermodynamics only. The real useful energy loss cannot be justified by the first law of thermodynamics, because it does not differentiate between the quantity and quality of energy. The present study introduces energy and exergy analysis and presents application of this methods on a hot water boiler in heating plant. In this paper, a hot water boiler was decomposed into control volumes with respect to its functional components. Energy and exergy of the created physical model of the hot water boiler is performed and destruction of exergy and energy loss in each of the components are calculated. The paper describes the current state of energy and exergy efficiency of hot water boiler, where the largest energy and exergy losses are identified.

**Key words:** hot water boiler, exergy, energy, availability, reliability

### INTRODUCTION

Hot water boilers, as the most commonly used central units in district heating system, require further analysis of reliability, safety and efficiency [7]. Considerable exploitation experience and former development have indicated new demands and possibilities of using hot water boilers, both in the municipal heating plants and in the process industry. Today, it is not only expected to have efficient operation in terms of energy efficiency of primary fuel, but also there are many strict requirements when it comes to cost-effective, reliable and safe operation [9].

Analysis of boiler plants in system of district heating are of scientific interest and also essential for the efficient energy utilization. Operation of hot water boilers is subjected to high temperature and pressure conditions, so that in addition to their efficiency it is necessary to considered safety and reliability of the system to avoid major operation disturbance and downtimes.

The most commonly used method for analysis of an energy conversion process is the first law of thermodynamics. Nowadays, there is increasing interest in the combined utilization of the first and second laws of thermodynamics, using such concepts as exergy and energy losses in order to evaluate the efficiency with which the available energy is consumed. Exergetic analysis provides the tool for a clear distinction between energy losses to the environment and internal irreversibility in the process [10].

Exergy analysis represents a methodology for the evaluation of the performance of devices and processes and involves examining the exergy at different points in energy-conversion processes. With this information, exergy efficiency can be evaluated and the process with the largest losses (the possibility for improvement) can be identified [12]. For these reasons, the modern approach to process analysis uses the exergy analysis, which provides a more realistic view of the process and a useful tool for engineering evaluation [17]. As a matter of fact, many researchers [1,6,13,15] have recommended that exergy analysis may be used in decision making regarding the allocation of resources (capital, research and development effort, optimization, life cycle analysis, materials, etc.) in place of or in addition to energy analysis [12]. Exergy analysis has become a key aspect in providing a better understanding of the process, to quantify sources of inefficiency and to distinguish quality of energy used [5]. Some researchers dedicated their studies to component exergy analysis and efficiency improvement [2,4], others focused on systems design and analysis [3,8,11,14,18].

The objective of this work is to analyze a hot water boiler plant from an energy and exergy perspective. Sites of primary energy losses and exergy destruction will be determined.

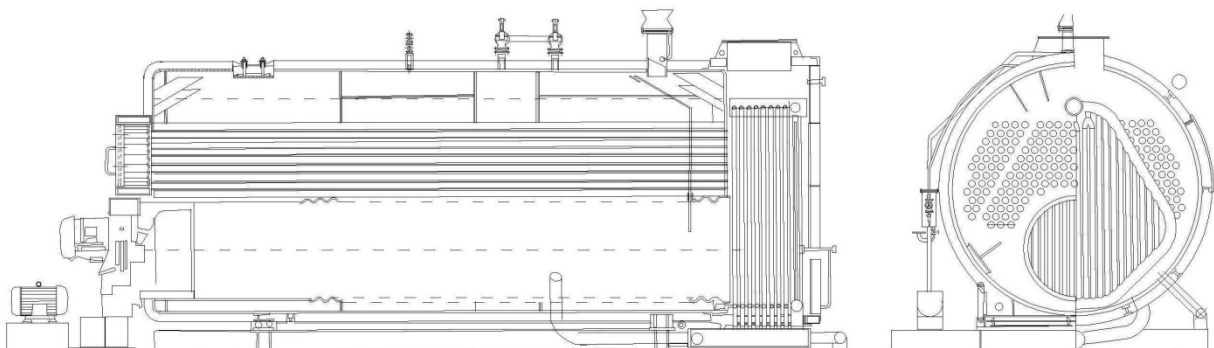
### GENERAL DESCRIPTION OF THE HOT WATER PLANT

Thermal plant “Technical faculties“ in Nis, with total capacity of 25,7 MW, uses natural gas fired hot water boiler type “TE110V”, manufactured by “Minel – kotlogradnja“. Below is the Table 1 with basic specifications of hot water boiler [16].

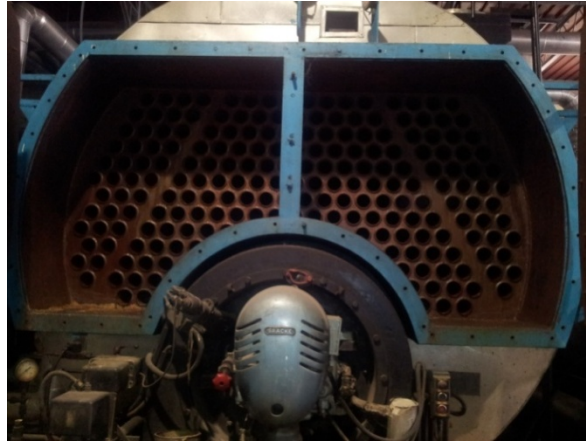
**Table 1.** Technical data of the boiler “Minel – kotlogradnja“

Boiler type	“TE 110V“
Capacity	8700kW
Efficiency	0.91
Furnace resistance	10.7 mbar
Mass	41000 kg
Boiler length	8060 mm
The temperature level of water	130/70 °C
Maximum allowed overpressure	12 bar
Operating pressure	6 bar
Total surface for heat transfer	351 m <sup>2</sup>
Water content in boiler	27,8 m <sup>3</sup>

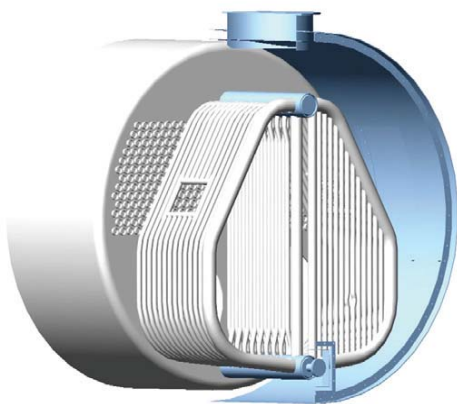
The boiler is shaped as a cylindrical tube, closed with chambers on both sides and thermally insulated all over the volume. The boiler has three pressurized gas channels. The flame pipe (first pass), located in the pressurized water body, is heated by thermal energy generated by combustion of natural gas. After combustion, exhaust gasses pass through a diverter chamber coated by water piping, go into the second pass gas piping (II pass gas pipes), placed above the flame tube. On the front side of the boiler is a frontal diverting chamber that redirects the exhaust gasses and leads them into the third pass gas piping, located on the sides of the boiler (III pass gas pipes). After leaving III pass gas pipes, exhaust gasses splash the water-cooled front of the diverting chamber, passing through the deflection chamber and then leaving the chamber through the chimney. During operations hot water boilers are completely filled with water normally. As for the water flow, the boiler is being filled with water on the bottom side of the boiler, below the flame tube. After filling the boiler, the portion of the water goes into the water-cooled front of reversing chamber, while the remaining volume of water is heated by radiation and convection passing through flue pipes (flame tube, gas pipes II and III pass). This water flow at the exit of the boiler is mixed with the water from the water-cooled front of diverting chamber and is then pumped to the consumers.



**Figure 1.** Schematic overview of the hot water boiler “Minel - kotlogradnja“

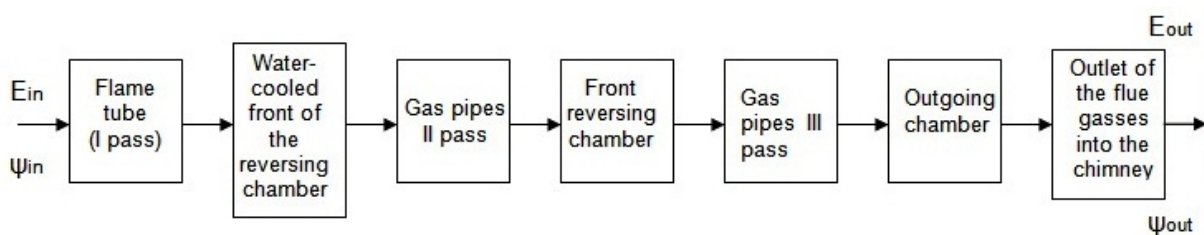


**Figure 2.** Current state of the hot water boiler “Minel - kotlogradnja“ – front view



**Figure 3.** Schematic representation of water-cooled front hot gas reversing chamber (left), the current state of water-cooled pipes (right)

Gas and water flow of the boiler can be distinguished, as shown below. The simplified view of the gas flow of the boiler is on the Fig. 4.



**Figure 4.** Gas flow of the hot water boiler

Since the boiler volume is full of water, water flow of the boiler can not be precisely distinguished, because there are no clearly defined boundaries of the boiler's component. For further analysis the only logical arrangement of the components of the water flow is adopted, which follows the arrangement of the components of the gas flow where the water flows. So the adopted arrangement of components of water flow is presented on Fig. 5.

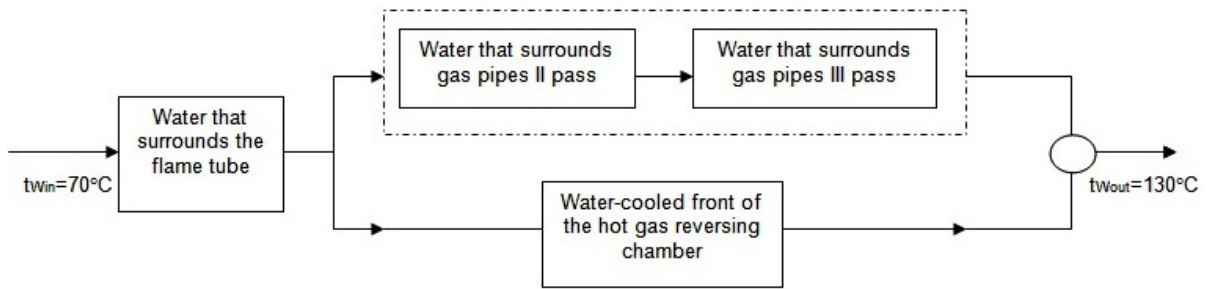


Figure 5. Water flow of the hot water boiler

## RESULTS AND DISCUSSION

When the analytical results are achieved, the following assumptions are adopted:

1. Water and gas temperature field are uniform on the control boundaries of each component of the hot water boiler.
2. The air temperature on the control surface is equal to the ambient temperature, so its exergy value is zero.
3. The entire amount of thermal energy in flame tube and in the irradiated chamber is transferred by radiation.
4. As the gas speed is quite large compared to the size of the front diverter chamber, it is considered that there is no heat transfer between the gas and water in the front chamber.

The calculation results for each component are given in Table 2.

As observed, the total energy efficiency for complete hot water boiler is 89.9%, while the exergy efficiency is only 60.97%, respectively in the entire system comes to the destruction of exergy of 39.03%, which is irreversibly lost in the environment.

Table 2. The results of efficiency calculations for each of the components of hot water boiler

Component	Energy efficiency $(\eta_i)$ [%]	Exergy efficiency $(\eta_{ex,i})$ [%]	Exergy destruction [%]
Flame tube	97.00	45.65	54.35
Water-cooled front of reversing chamber	99.00	65.57	34.43
Gas pipes II pass	99.00	84.16	15.84
Gas pipes III pass	99.00	93.52	6.48
Total	89.895	60.97	39.03

In order to make the representation of results more clear and to see what is going on in the system, it is necessary to consider energy and exergy loss in relation to the system in general (Table 3).

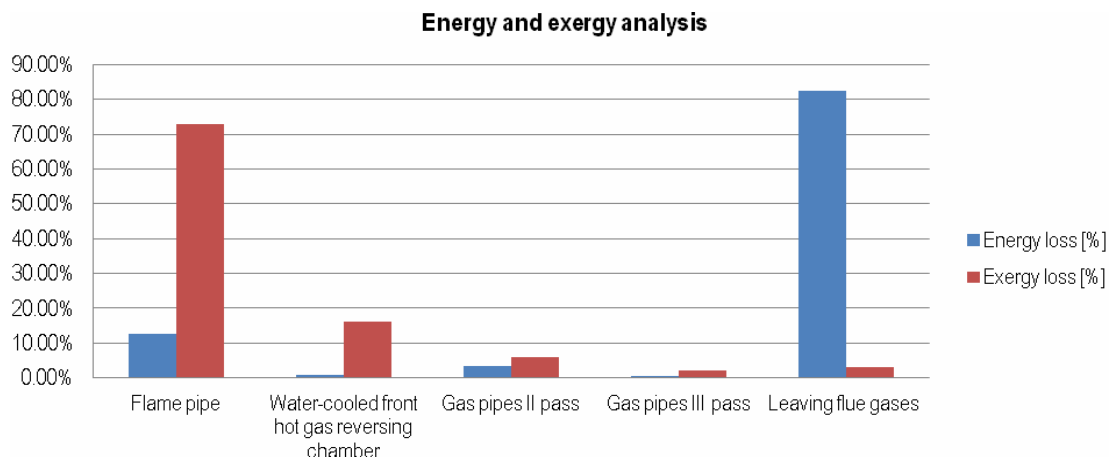
Table 3. The results of calculations for each of the components of hot water boiler in relation to the entire system

Component	Energy loss [kJ/s]	Energy loss [%]	Exergy loss [kJ/s]	Exergy loss [%]
Flame tube	126.495	12.57	5497.087	73.06
Water-cooled front of reversing chamber	8.674	0.86	1212.384	16.11
Gas pipes II pass	34.993	3.48	440.308	5.85
Gas pipes III pass	5.456	0.54	151.565	2.01
Flue gases leaving the boiler	830.752	82.55	223.157	2.97

Based on the given results of energy and exergy analysis, it can be concluded that the greatest exergy loss occurs in the flame tube of the hot water boiler, while the largest energy loss of the system takes

place in the area where the gases leave the boiler. The exergy loss through each of the components of the gas flow of the hot water boiler can be traced. Exergy loss, obtained analytically, amounts from 73.06% in the flame tube, 16.11% in water-cooled front of the reversing chamber, 5.85% in gas pipes II pass, 2.01% in gas pipes III pass, while exergy loss of flue gases leaving the boiler through the chimney is 2.97%. The major exergy loss occurs in the flame tube, which was expected, because of the chemically irreversible process of fuel combustion. Exergy of exhaust gasses depends on the temperature at which the combustion heat is transferred to the flue gases. Due to the large temperature difference of combustion products in the flame pipe at high temperatures (1350 - 1450 °C) and hot water heated to 90 - 100°C, and heat transfer done by radiation, the greatest exergy destruction can be related to the flame pipe.

It may be also noted that, following the gas flow of the boiler, the reduction of exergy losses and increasing of exergy efficiency takes place. Based on the obtained results it can be seen that the trend of increasing exergy efficiency is not present in the water-cooled front, which can be explained by different type of heat exchangers. Namely, II and III pass gas pipes are associated to cross-section exchangers, where water flows around the pipes, while in the water-cooled front of reversing chamber water flows along the pipes, while exhaust gasses flow around the pipes, directed by diverter chamber. Analytic analysis of energy and exergy balance shows that the greatest potential for increasing overall efficiency of the plant is actually in the flame tube of the hot water boiler. Fig. 6 graphically represents the distribution of energy and exergy loss for each of the components of the hot water boiler.



**Figure 6.** Comparative graphical review of energy and exergy analysis of hot water boiler



**Figure 7.** Damaged water-cooled pipes of the diverting chamber of the hot water boiler (left and right)

## CONCLUSION

The water-cooled pipes on the back of the flue gas diverter chamber is exposed to high temperature strain, which results in damage of this part of the diverter chamber (Fig. 7) and drop outs of the boiler. This fact reduces availability and reliability of the boiler. Fig. 7 shows the current state of damaged wall of water-cooled pipes of the diverting chamber. For further analysis can be observe the case with

retrofit design of hot water boiler. In order to have more reliable solution it can be observed the case by omitting the piping from the walls of the chamber. In this case, the complete volume flow of the water would flow over the flame pipe, and II and III pass gas pipes in the main body of the boiler. It is assumed that an equal amount of delivered energy and exergy is delivered with the fuel and air to the boiler. In the case of modified contraction, due to lack of the water-cooled pipes on the walls of the diverter chamber, available heat is transferred completely to the main body of the water, and the flue gasses after leaving the III pass gas pipes, are redirected through the deflection chamber through the chimney.

According to the performed analysis, it is shown that energy and exergy analysis can be used to pinpoint energy loss, exergy loss and exergy destruction in the structure of hot water boiler plants. In order to pinpoint locations of these losses, it is necessary to create a physical model of the boiler, by applying decomposition of the boiler with respect to function of each of its components. The obtained results may be used to further investigate possibilities of design modification to address reliability and availability issues, caused by regular damage of water-cooled pipes in the gas diverter chamber.

## REFERENCES

- [1] Alefeld, G., Heat Conversion Systems, CRC Press, Boca Raton, FL, 1993.
- [2] Badran, O., Gas-turbine performance improvements, Applied Energy, Vol.64, pp.263–273, 1999.
- [3] Bilgen, E., Exergetic and engineering analyses of gas turbine based cogeneration systems, Energy, Vol.25, pp.1215–1229, 2000.
- [4] Carcaschi, C., Facchini, B., Comparison between two gas turbine solutions to increase combined power plant efficiency, Energy Conversion and Management, Vol.41, pp.757–773, 2000.
- [5] Dincer, I., Al-Muslim, H., Thermodynamic analysis of reheat cycle steam power plant, International Journal of Energy Research, Vol.25, pp.727–739, 2001.
- [6] Dincer, I., Cengel, Y.A., Energy, entropy and exergy concepts and their roles in thermal engineering, Entropy, Vol.3, No.3, pp.116–149, 2001.
- [7] Hasanuzzaman, M., Saidur, R., Rahim, N.A., Energy, exergy and economic analysis of an annealing furnace, International Journal of the Physical Sciences, Vol.6, pp.1257–1266, 2011.
- [8] Huang, F.F., Performance evaluation of selected combustion gas turbine cogeneration systems based on first and second-law analysis, Journal of Engineering for Gas Turbines and Power, Vol.112, pp.117–121, 1990.
- [9] Katavić, B., Jegdić, B., Analysis of damages on water boiler shield pipes, Welding and Welded Structure, Vol.4, pp.123–130, 2007.
- [10] Kopac, M., Hilalci, A., Effect of ambient temperature on the efficiency of the regenerative and reheat Çatalagzi power plant in Turkey, Applied Thermal Engineering, Vol.27, pp.1377–1385, 2007.
- [11] Marrero, I., Lefsafer, A., Razani, A., Kim, K., Second law analysis and optimization of a combined triple power cycle, Energy Conversion and Management, Vol.43, pp.557–573, 2002.
- [12] Rosen, M., Dincer, I., Effect of varying dead-state properties on energy and exergy analyses of thermal systems, International Journal of Thermal Sciences, Vol.43, pp.121–133, 2004.
- [13] Rosen, M., Dincer, I., Exergy as the confluence of energy, environment and sustainable development, Exergy International Journal, Vol.1, No.1, pp.1–11, 2001.
- [14] Sue, D., Chuang, C., Engineering design and exergy analyses for combustion gas turbine based power generation system, Energy, Vol.29, pp.1183–1205, 2004.
- [15] Szargut, J., Morris, D.R., Steward, F.R., Exergy Analysis of Thermal, Chemical and Metallurgical Processes, Hemisphere, New York, 1988.
- [16] Technical documentation of hot water boilers "Minel Kotlogradnja" Belgrade, 1996.
- [17] Utlu, Z., Hepbasli, A., A review on analyzing and evaluating the energy utilization efficiency of countries, Renewable and Sustainable Energy Reviews, Vol.11, pp.1–29, 2007.
- [18] Verkhivker, G., Kosoy, B., On the exergy analysis of power plants, Energy Conversion and Management, Vol.42, pp.2053–2059, 2001.

## TREND GROWTH OF SOLAR THERMAL SYSTEMS - FOR THE PERIOD SINCE 2009. BY 2012. YEAR

Miroslav Lambić<sup>1</sup>, Novica Pavlović<sup>2</sup>

<sup>1</sup>University of Novi Sad, Technical Faculty "Mihajlo Pupin", Zrenjanin, Serbia

<sup>2</sup>Higher School of Professional Business Studies, Novi Sad, Serbia

e-mail: [lambic@ptt.rs](mailto:lambic@ptt.rs)

**Abstract:** This paper presents the development trend of solar thermal systems - for the period until 2009. , and in particular - since 2009. - by 2012. year. Display includes 53 ( 2009) till 56 (2012) countries. Is given the data of installed solar capacity - and especially in the ten leading economic countries. Shown installed solar capacity by type of thermal solar collectors and glazed and unglazed flat solar collector with liquid working medium and air as working medium. The percentage shown participation vacuum tube and flat solar collectors in total installed capacity. Given the average installed unglazed and glazed solar collectors per 1.000 inhabitants - in some countries of the world .

### INTRODUCTION

Solar energy can have a significant place in energy sector of a country because it presents renewable and inexhaustible energy resource. Not the same attention to renewable energy resources is paid everywhere in the world. We can freely say that relatively small number of countries - the ones most developed - pays more attention to this issue. It is interesting that the energy technologies based on the use of solar radiation are being developed the most in technologically and economically powerful countries. There are several reasons, from which the most important are strategic, economical and ecological factors.

Solar energy is ecologically viewed clean energy whose energy technologies do not pollute the environment. It presents the resource that each country has available - without import dependence. It is especially significant fact that the plants for solar energy use can be constructed immediately next to the consumers - without significant investments into infrastructure. With technical means solar energy simply is transformed directly into heat and, directly or indirectly, into electricity, which enables fast application in all energy processes. The use of solar energy in all segments of energy consumption is in significant increase in many countries of the world today.

Solar energy is very attractive and economically justified for use, even with the heating of households, industrial and other facilities. Huge savings of conventional energy could be achieved if each household would have at least one unit of solar collector by which sanitary consumable water would be heated.

Seen in electro-energetic system of a state, it would represent quite load shedding. Especially interesting group of heating energy consumers are numerous industrial, tourist, sporting, medical, military and other facilities. It is known that these facilities spend considerable quantities of energy, derived by burning solid, liquid and gas fuels for heating. This can be easily achieved by using very simple systems for using solar energy.

### TREND OF GROWTH

From all operational systems (implemented in 53 countries in the world by 2009.) of capacity 172.368,6 MW, on vacuum pipe collectors goes 96.539,1 MW, on glass-plated flat collectors - 54.915,5 MW, not glass-plated - swimming pool and other collectors - 19.703,9 MW and the least on air collectors - 1.210,2 MW. The total collector area in use by end of 2009. is approximately 246.240.885 m<sup>2</sup>!

Total capacity of solar collectors in operation - is shown in Figure 1 and Figure 2 presents the total installed capacity of water and air thermal collectors in the leading ten countries - the end of 2009. year.



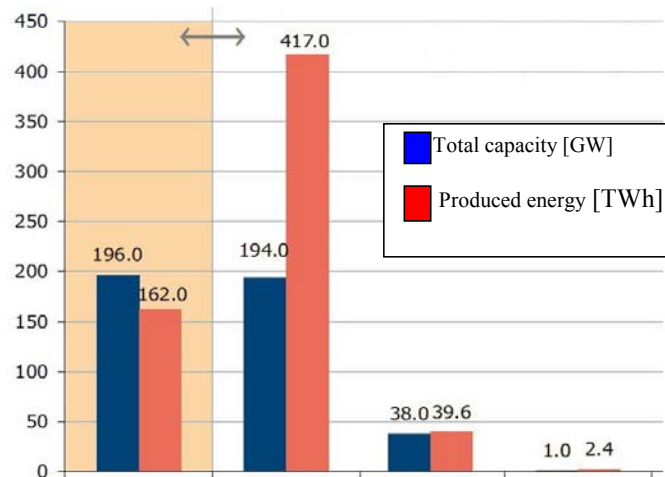


Figure 1. Total capacity in operation [GW] - 2009. and annually energy generated [TWh]

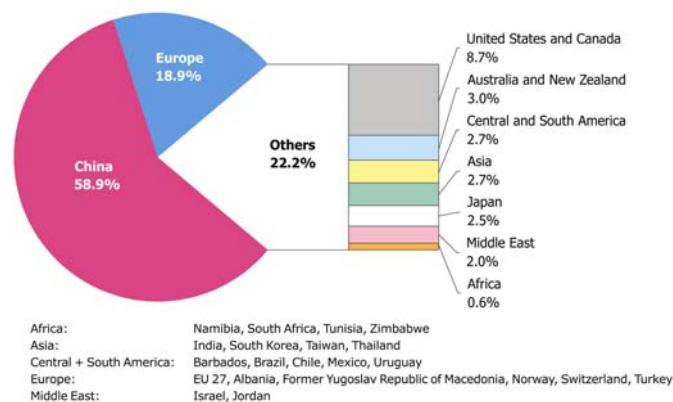


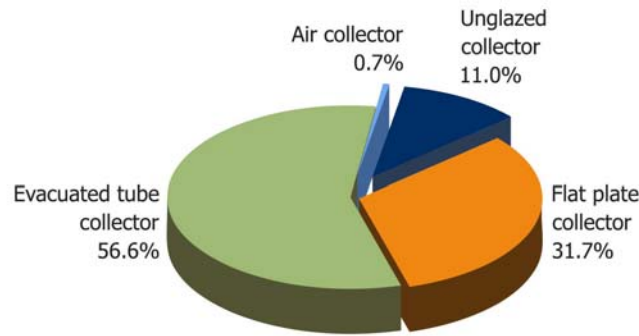
Figure 2: Share of the total installed capacity in operation (glazed and unglazed water and air collectors) by economic regions at the end of 2009.

Average annual growth of solar thermal systems - between 2000th and 2009th year was 20.8%. Compared with the 2008th year, the global market glazed solar collectors had a growth of 27.3% - the 2009th year (while in the period 2007/2008. it was 36.5%).

The structure of installed solar collectors, the dominant application are installed for water heating in households. Significant, but less space with greater water heating systems in buildings with multiple dwellings, in tourism, the public sector and others. In Europe, the significant use of larger combined system for domestic water heating and space - in homes and large residential buildings.

The 2009th year of newly glazed and unglazed water and air solar collectors mostly relate to the installation of heating domestic hot water production. A significant increase in the share of the total capacity has been made in the use of solar combi systems (heating domestic hot water and heating for households), but only in Europe, USA and Canada. A significant increase in the capacity of solar systems designed for water heating industry (Middle East, Asia, and China) as well as the capacity of water heating systems for multi - family houses (Europe, China). See an increase in the use of solar installations in tourism - mainly for domestic water heating (Middle East, China, Asia, Europe). Are noticeable, but less than other sectors and the use of facilities that were built in facilities in the public sector, such as hospitals, schools, nursing homes and others. (Asia, China, Middle East). The minimum capacity of the newly built solar system in the domain of the use of district heating and air conditioning ( Europe).

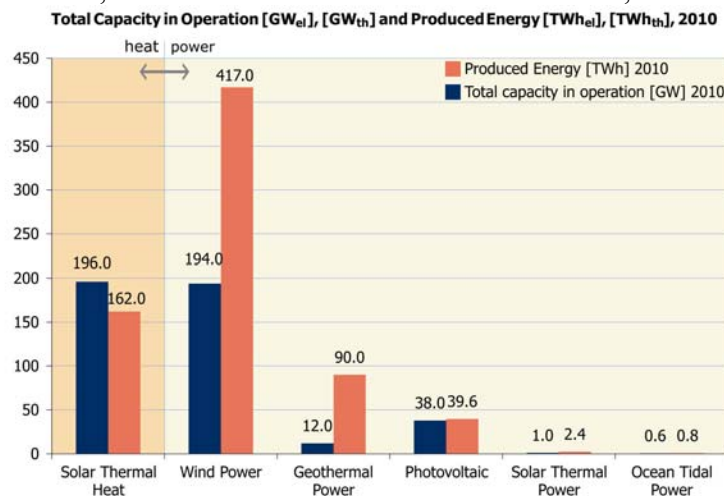
By 2010-the year in Europe has installed about 47 million m<sup>2</sup> of solar thermal collectors, and only China in 2009-the same year installed a 31 million m<sup>2</sup> of solar thermal collectors. The growth rate of installed solar thermal collectors in some European countries is over 25%. It can see that from the viewpoint of the intensity of the sun's energy or the surface of the installed solar panels and production, the absolute leading country - China.



**Figure 3.** Distribution of the total installed capacity in operation by collector type in 2010.

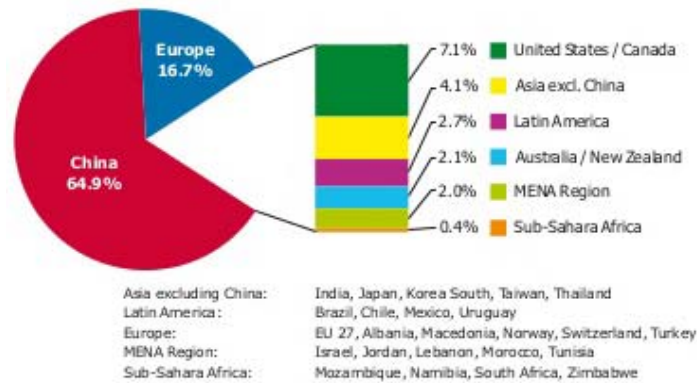
According to the competent annual report "Solar Heat Worldwide", edition for 2011, on the state of solar heating with the market survey and the contribution of thermal solar energy in the world - estimated overall production and installed capacities at the end of 2010 - in the area of thermal conversion are 196 GW (with about 280.000.000 m<sup>2</sup> of solar collectors) - of installed power plants with annual produced thermal energy of 162 TWh. In this report a large number of countries in the world are included, from which almost all countries in Europe (except for few - including Serbia). To given data the capacities in the field of photo - electric plants with overall capacity of 38 GW installed and annually produced electricity of around 39,6 TWh should be added. Significantly smaller existing capacities relate to heliostat solar plants that are estimated power of 1,0 GW with produced electricity of around 2,4 TWh.

From all operational systems (2009.) of capacity 172.368,6 MW, on vacuum pipe collectors goes 96.539,1 MW, on glass-plated flat collectors - 54.915,5 MW, not glass-plated - swimming pool and other collectors - 19.703,9 MW and the least on air collectors - 1.210,2 MW.

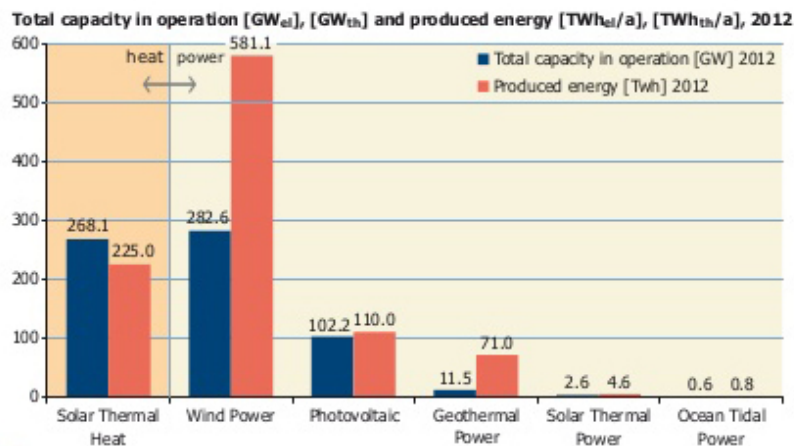


**Figure 4.** Total capacity in operation [GW] - 2010. and annually energy generated [TWh]

By the end of 2011., the installed capacity of solar thermal collectors amounted to 234.6 GW as a result of installing the 335.1 million square meters of solar collectors that are in operation in 56. These countries present 4.3 billion people, or about 61 % of world population.



**Figure 5.** Share of the total installed capacity in operation (glazed and unglazed water and air collectors) by economic regions at the end of 2011



**Figure 6.** Total capacity [GW] in operation 2012. y. and annual energy generated [TWh]

Average of installed unglazed and glazed solar collectors per 1,000 inhabitants per country as follows: Cyprus - 542 kW/1000 inhabitants, Austria - 406 kW/1000 ; Israel - 400 kW/1000; Barbados - 322 kW/1000; Greece - 268 kW/1000; Australia - 212 kW/1000; Germany - 131 kW/1000; Turkey - 129 kW/1000; China - 114 kW/1000 and Jordan 114 kW/1000 inhabitants.

## CONCLUSION

In 2011-the new installed capacity was 48.1 GW (67,000,000 m<sup>2</sup> of collector). This is an increase of 14.3% compared to 2010. year. As the growth in use of solar installations dynamic -shows so that in 2012, the installed capacity of solar thermal collectors around 268.1 GW, or about 383 million square meters of solar collectors. This has produced a basis for energy production of 225 TWh (it is equivalent to saving 24 million tons of oil and reduce carbon dioxide emissions by 73.5 million tons).

## REFERENCES

- [1] Lambić, M., Solarne instalacije i objekti, Društvo za sunčevu energiju "Srbija solar", 2004.
- [2] Lambić, M.; Pavlović, T.; Tolmač, D.; Pavlović, M.; Prvulović, S.; Pavlović, N.; Pekez, J.; Milosavljević, D.: Studija o proceni ukupnog solarnog potencijala - Solarni atlas i mogućnosti "proizvodnje" i korišćenja solarne energije na teritoriji AP Vojvodine, Izvršno veće AP Vojvodine, Pokrajinski sekretarijat za energetiku i min. sirovine, Novi Sad, 2011.
- [3] Lambić, M.: Stanje i tendencije u korišćenju sunčeve energije - u svetu i Srbiji, Zbornik radova Međunarodne naučne konferencije: Obnovljivi i raspoloživi izvori energije, Novi Sad, 2012.
- [4] Pavlović, T.; Milosavljević, D.; Mirjanić, D.: Obnovljivi izvori energije, Akademija nauka i umjetnosti Republike Srpske, Banja Luka, 2013.
- [5] Lambić, M.: Solarne tehnologije, SGM knjiga, Beograd, 2013. [www.agridry.com.au](http://www.agridry.com.au)

## **SESSION 2: Engineering Environmental Protection and Safety at Work**

## RISK ANALYSIS IN THE REFINING INDUSTRY

James G. Speight<sup>1</sup>, Ljiljana Radovanović<sup>2</sup>

<sup>1</sup> CD&W Inc., Laramie, Wyoming, USA

<sup>2</sup> University of Novi Sad, Technical Faculty "Mihajlo Pupin", Zrenjanin

E-mail: [jamesSp8@aol.com](mailto:jamesSp8@aol.com)

**Abstract:** Risk analysis (hazard evaluation methodologies) in refineries involves techniques that are an integral part of a process safety management program. These techniques permit plant operators, maintenance planners, and refinery managers to know what they can obtain from a hazard evaluation and which one could fit their needs. Frequently, these techniques are only deemed necessary or receive managerial attention prior to the design of a new plant, a major revamp or when an accident or serious incident occurs. However, a refinery is a collection of unit processes, each of which operates in concert with the others to produce saleable products. Risk analysis for the refinery as a whole is itself of questionable validity and a risk analysis must be performed for each unit process. The approach used in this article is to examine the various types of risk throughout a refinery using chemistry and engineering as the background from which to work. Relevant decisions are based upon objective scientific and engineering evidence rather than subjective evidence and thereby stand a better chance of identifying and mitigating the various risks.

**Key words:** risk analysis, refining industry

### INTRODUCTION

Risk evaluation (hazard evaluation methodologies) is an integral part of a process safety management program. These techniques permit plant operators, maintenance planners, and refinery managers to know what they can obtain from a hazard evaluation and which one could fit their needs. Frequently, these techniques are only deemed necessary or receive managerial attention prior to the design of a new plant, a major revamp or when an accident or serious incident occurs. The use of these techniques provides safeguards that prevent and protect against process upsets and contribute towards devising solutions for the minimization of possible catastrophic or non-catastrophic outcomes. It is recommended that these techniques be used on an on-going recurrent basis. Both operators and management should become familiar and apply them recurrently and consistently, not only leaving them to the specialists.

Independent testing can serve as an protection to reduce the technical risks of new process technology factors which contribute to technical risks not only when implementing new process technologies in the refining industry but during the operation of mature refineries, as well as the changes that occur in the crude slate on a weekly if not daily basis (ASTM, 1998; Murray et al., 2006; Payne, 2011). In addition, the complex nature of heterogeneous catalysts used in the conversion of those fractions to marketable products must also be a part of risk assessment. Furthermore, reactor hydrodynamics and operational issues can pose significant technical risks.

However, a refinery is a collection of unit processes, each of which operates in concert with the others to produce saleable products. Risk analysis for the refinery as a whole is itself is of questionable validity and a risk analysis must be performed for each unit process. Thus, risk cannot be mitigated unless it is first assesses for each specific unit process which, considering the complexity of a refinery, can be an enormous undertaking and requires a significant amount of time and resources. Multiple failure scenarios exist on every single vessel, tank, pump, compressor and piping circuit. And each failure scenario has numerous possible consequences. For the various pieces of equipment used for the unit processes, it is necessary to consider the various degradation mechanisms that may apply. The available inspection data, process conditions, and past history can be used to determine the probability of failure over the specified timeframe. Consider the experiences of other refineries as well. The approach used in this article is to examine the various levels of risk throughout a refinery using chemistry and engineering as the background from which to work. Relevant decisions are based upon objective scientific and engineering evidence rather than subjective evidence and thereby stand a better chance of identifying and mitigating the various risks.

## REFINERY RISKS

When considering technical risk in the refining industry, the crude oil feedstock is a major contributor. Crude oil is a complex mixture of hydrocarbons and hydro carbonaceous derivatives (nitrogen-, oxygen-, and sulfur-containing species as well as metal-containing constituents) that boil over a wide range of temperatures. Reaching beyond the maximum cut points of vacuum-packed column distillation (approximately 1040°F, 560°C) and compositional fractionation methods indicate that the maximum atmospheric equivalent boiling point of crude oil exceeds 2500°F (1370°C) (Speight and Ozum, 2002; Hsu and Robinson, 2006; Gary et al., 2007; Speight, 2014). Indeed with the reality that changes in the slate of crude oil feed stocks is already including more heavy oil and tar sand bitumen components and the projection that that refining industry will continue in its present form (or at least in a similar form) well into the 21 Century (Speight, 2011) there is the need to emphasize the continuation of risk analysis for the refining industry.

### Feedstock Changes

The technical risk associated with the complexity of feed stock composition is that the potential outcome of a process technology implementation involving anew feedstock may not be completely known, since no two crude oils are the same (Speight, 2014). In spite of many claims of success, a complete composition analysis of the more complex feed stocks such as heavy oil and tar sand bitumen is impossible and that simplified assumptions (always a risk) must be made (Khader and Speight, 2005).

Thus, instead of focusing on individual compounds (and promising that petroleomics will solves everything in terms of composition) or focusing on groups of compounds that fall into similar chemical classifications, a study of real refinery behavior and any associated risks is necessary. Indeed, the less that is known about the feedstock, the greater the technical risk and the higher the probability of failure during some aspect of refinery operations.

### Feedstock Compatibility

Current refineries are a complex series of manufacturing plants that can be sub-divided into (1) separation processes, (2) conversion processes, and (3) finishing processes (Speight and Ozum, 2002; Hsu and Robinson, 2006; Gary et al., 2007; Speight, 2014). Incompatibility can occur not only in petroleum products but also in the crude oil blends used as the refinery feedstock.

However, incompatibility of different crude oils, which can occur if, for example, a paraffinic crude oil is blended with heavy asphaltic oil, can cause sediment formation in the unrefined feedstock or in the products, thereby complicating the refinery process (Mushrush and Speight, 1995; Abu-Khader, and Speight, 2007; Speight, 2014).

The technical risk associated with feedstock complexity and the potential for incompatibility of the component blends can be assessed by use of analytical methods (Speight, 2014) and the potential for such an event can be mitigated.

### Catalyst Risks

Another important factor affecting risk assessment is the heterogeneous catalyst used in the conversion process. The composition of a solid catalyst can be complex; the catalyst is often dual-functional, in that the acidic function provided by the zeolite catalyzes cracking and isomerization reactions, and the metal function catalyzes hydrogenation reactions, as is the case with hydro cracking catalysts.

Moreover, a binder, such as alumina, is used as support or to give the solid catalyst particle mechanical strength. Although substantial advances have been made in understanding heterogeneous catalysts, factors such as diffusion limitations, poison sensitivity, limited understanding of reaction mechanism sand of the structure of the active sites contribute to technical risk.

Again, the technical risk associated with catalyst complexity is that the potential outcome of new process technology involving a new catalyst is not completely known.

## **Reactor Hydrodynamics**

In a trickle-bed reactor, the ideal flow pattern is that the liquid flows as a continuous film over the catalyst particles, with the hydrogen flowing through the remaining void space and diffusing through the liquid film to the catalyst surface. However, commercial trickle-bed operations have been shown to be non-ideal and are affected by, for example, liquid and gas mal-distribution and mass transport limitations.

The probability of failure in such a situation is difficult, if not impossible, to calculate. However, a hydrotreater that is not able to meet the performance standards predicted by realistically-operated pilot plant units, the probability of failure of a commercial trickle-bed hydrotreater becomes an issue.

## **Operational Risks**

Risks that are often overlooked are the risks associated with operational issues that are due to problems arising from the operation of an existing refinery unit. These include issues related to plugging of reactors, excessive wear of control valve stems or unanticipated corrosion of equipment.

In fact, switching to acceptance and processing heavy oil and tar sand bitumen feed stocks other than conventional crude oil in a refinery built for processing conventional feed stocks will most likely lead to unanticipated operational problems. For example, hydro processing heavy feedstock is affected by reactor bed plugging due to reacted asphaltene species that are incompatible with the liquid phase, fines, such as dirt, sand, salt and corrosion products.

Again, the less is known about potential operational problems, the greater the risk and the higher the probability of failure of the process.

## **Environmental Risks**

The environmental risk assessment methods deal with different factors and parameters. However, it is necessary to ensure that all of the environmental parameters, risks, and the consequences of any environmental leaks have been considered. Identifying the proper method of risk assessment may lead to pursuing scientific and operational management of risks besides substantial study of all the identified hazards.

Environmental risk performance assessment studies are used upon applying environmental assessment approach and focus on an analysis of the weaknesses and strengths of risk assessment of human and natural systems in comparison with safety and environmental standards, rules, regulations, and requirements. In other words, the environmentalists intend to make an assessment in regard to the function of the development project and how to study and control the identified risks in the preceding phase by this approach. Relying on the results of this assessment, it is revealed that which part of the subject system is sensitive to performance or has a problem since the goals if such studies are to provide the most useful short-term and long-term solutions through technical, economic, and environmental justifications. Different steps of research methodology and environmental risk performance.

Thus, the main objectives of risk assessment process in the environment are: (1) reducing the frequency and severity of accidents, (2) minimizing damages to ecosystems, (3) supplying safe conditions for the flora and fauna, including humans, and (4) ensuring that the relevant rules and regulations are in place and understood by refinery personnel. Omission of risks and hazards, identifying methods of the environment protection, codifying safety plans, preparing documents and reducing the environmental damages are among advantages of environmental risk assessment (Narimisa et al., 2013).

## **MITIGATING REFINERY RISKS**

The concept of risk and risk mitigation measures are well developed in the field of process plant safety to evaluate the hazard potential of refinery installations or changes to refinery installations. Risk mitigation measures can be categorized according to the degree of quantification.

Foremost, the location of the risk determines its priority. The combination of high probability and high

consequence likely means urgent action is needed; while low probability and low consequence conveys minimal to no action needed. Once a comprehensive list of risks along with their relative priority has been assembled, managing these risks becomes easier. A reasonable criteria can be created determine the urgency of addressing each risk. There are several methods available for evaluating risk assessment and the emphasis must be on the most appropriate method for the task. The approach must provide information on both refinery management and risk barrier failures (Kalantarnia et al., 2010; Pitblado and Fisher, 2012).

For example, *hazard and operability studies* (HAZOP studies) are qualitative and simplified quantitative methods, such as the *chemical exposure index* (CEI) as well as the *fire and explosion index* (F&EI), use relative rankings of hazards. Furthermore, the hazard and operability study involves a multi-disciplinary team and is a structured and systematic examination of a planned or existing process or operation in order to identify and evaluate problems that may represent risks to personnel or equipment, or prevent efficient operation. A HAZOP is a qualitative technique based on guide-words and is carried out (HAZOP team) during a set of meetings.

The overall outcome of the HAZOP team is a determination of the possible significant *deviations* from each intention, feasible *causes* and likely *consequences*. It can then be decided whether existing, designed safeguards are sufficient, or whether additional actions are necessary to reduce risk to an acceptable level (Abu-Khader, and Speight, 2004).

Full quantitative methods, such as refinery quantitative risk analysis completely quantify the risks associated with an event. Moreover, layer of protection analysis (LOPA) identifies independent layers of protection that reduce risk. An independent protection layer (IPL) is a device, system, or action that is capable of preventing a scenario from proceeding to its undesired consequence independent of the initiating event or the action of any other layer of protection associated with the scenario (Absil, 2011).

## CONCLUSIONS

Factors contributing to technical risks when implementing new process technologies in the refining industry include feed stock complexity, catalyst complexity, reactor hydrodynamics, and operational issues.

Risk analysis can be used in refinery plant safety and analytical data illustrating feedstock behavior as well as independent pilot plant testing services can serve as independent findings to reduce these risks. The experience can show how risk analysis can be applied to mitigate the risk of for example (1) crude oil incompatibility, (2) product incompatibility, and (3) reactor bed plugging.

The motivation of such an analysis is to quantify the risks that are associated when introducing new feed stocks to a refinery or implementing new process technology in the refinery so that they can be controlled. Decisions must be made on objective quantified evidence so that risks can be minimized.

Finally, a risk assessment program that does not function well can be almost as dangerous as not having one. If the right risks aren't identified or if the risks are not quantified correctly it can give the refinery management and personnel a false sense of security, or force them to spend money in the wrong areas (Payne, 2011). If the risk analysis is incomplete, there may be some major issues lurking that aren't getting the deserved attention. If the quantification of the risk is inconsistent, management may lose trust in the system and stop utilizing it in order to make decisions. By understanding and assessing underlying risk factors and predictors of catastrophic incidents, refinery and chemical plant operators can better plan, develop and prioritize appropriate mitigation plans (Walters and Ross, 2011). In addition, it is critical that the right resources are dedicated to the proper identification and quantification of risks at your refinery. A properly functioning program will minimize unnecessary work and prevent major failures in the future.

## REFERENCES

- [1] Absil, R. 2011. Protection Analysis in Refining. *Petroleum Processing Quarterly*, 16(Q1): 1-9. [www.digitalrefining.com/article/1000430](http://www.digitalrefining.com/article/1000430), accessed July 20, 2013.
- [2] Abu-Khader, M.M., and Speight, J.G. 2004. The Concepts of Energy, Environment, and Cost for Process Design. *International Journal of Green Energy*, 1(2): 137.



- [3] Abu Khader, M.M., and Speight, J.G. 2007. Influence of High Asphaltene Feedstocks on Processing. *Rev. de l'Institut Français du Pétrole*, 62: 715.
- [4] Abu-Khader, M.M., and Speight, J.G. 2005. Bitumen Processing Developments. *Petroleum Technology Quarterly*. 2005, 10(3): 55-61.
- ASTM. 1998. Standard Provisional Guide for Risk-Based Corrective Action. Publication No. PS104-98. American Society for Testing and Materials (ASTM), West Conshohocken, Pennsylvania.
- [5] Gary, J.G., Handwerk, G.E., and Kaiser, M.J. 2007. *Petroleum Refining: Technology and Economics*, 5<sup>th</sup> Edition. CRC Press, Taylor & Francis Group, Boca Raton, Florida.
- [6] Hsu, C.S., and Robinson, P.R. (Editors) 2006. *Practical Advances in Petroleum Processing Volume 1 and Volume 2*. Springer Science, New York.
- [7] Kalantarnia, M., Khan, F., and Hawboldt, K. 2010. Modeling of BP Texas City Refinery Accident Using Dynamic Risk Assessment Approach. *Process Safety and Environmental Protection*, 88: 191-199.
- [8] Murray, A., Wood, M., and Beckett, V. 2006. *Improving Major Hazard Control at Petroleum Oil Refineries: Key Points and Conclusions*. European Commission, Directorate-General Joint Research Center, Institute for the Protection and Security of the Citizen and the Health and Safety Executive, Bootle, Borough of Sefton, Merseyside, United Kingdom.
- [9] Mushrush, G.W., and Speight, J.G. 1995. *Petroleum Products: Instability and Incompatibility*. Taylor & Francis Publishers, Washington, DC.
- [10] Payne, D. 2011. Independent Verification of Refineries. *Petroleum Technology Quarterly*, 16(Q1):
- [11] [www.digitalrefining.com/article/1000428.Independent\\_verification\\_of\\_refineries\\_.html](http://www.digitalrefining.com/article/1000428.Independent_verification_of_refineries_.html), accessed July 13, 2013.
- [12] Pitblado, R., And Fisher, M. 2012. A Novel Investigation Approach Linking to Risk Assessment. *Petroleum Technology Quarterly*, 17(Q2):
- [13] [www.digitalrefining.com/article/1000367](http://www.digitalrefining.com/article/1000367), accessed July 13, 2013.
- [14] Rezaie Narimisa, N., Ahmad Basri, N.E., Bin Jaafar, O., and Rezaie Narimisa, M. 2013. Environmental Impact Assessment and the Sustainable Development of the Oil Refineries in Iran: Assessing Impacts and Possible Solutions. *J. Basic. Appl. Sci. Res.*, 3(4): 881-892.
- [15] Speight, J.G., and Ozum, B. 2002. *Petroleum Refining Processes*. Marcel Dekker Inc., New York.
- [16] Speight, J.G. 2011. *The Refinery of the Future*. Gulf Professional Publishing, Elsevier, Oxford, United Kingdom.
- [17] Speight, J.G. 2014. *The Chemistry and Technology of Petroleum*. 5<sup>th</sup> Edition. CRC Press, Taylor and Francis Group, Boca Raton, Florida.
- [18] Speight, J.G., Radovanovic, Lj., *The Evolving Refinery and Risk Analysis*, II International Conference Industrial Engineering and Environmental Protection 2012 (IIZS 2012), October 31<sup>th</sup>, 2012, Zrenjanin, Serbia, ISBN 978-86-7672-184-9, p. 53-58
- [19] Walters, N., and Ross, B. 2011. *Predicting and Mitigating the Risk of Catastrophic Incidents*. Hart Energy, Houston, Texas. September.

## RISK ASSESSMENT FOR CONSTRUCTION OF BRIDGE ON MOTORWAY

Vangelce Mitrevski, Tale Geramitcioski, Vladimir Mijakovski, Monika Lutovska  
University "St. Kliment Ohridski", Faculty of Technical Sciences, Bitola, FYR Macedonia  
e-mail: vangelce.mitrevski@uklo.edu.mk

**Abstract:** In this paper, risk assessment for the activities associated with construction of bridge as part of the risk assessment for the project comprising building of new motorway section from Demir Kapija to the village of Smokvica, Republic of Macedonia is presented. After identified risks and hazards, during activities related with bridge works and after performed risk assessment, control measures are proposed.

**Key words:** risk assessment, motorway, bridge, control measures

### INTRODUCTION

Branch of AKTOR ADT Greece in the Republic of Macedonia is the main contractor building the rest of the highway A-1 (E-75) from the town of Demir Kapija to the village Smokvica as part of the Pan-European Corridor X. The challenge on this project is to develop 28 km of new motorway section through difficult and environmentally sensitive terrain. Construction of the highway section, among other things will include construction-drilling of 2 twin tunnels with a total length of 4.5 km, 6 major river bridges/viaducts, 2 interchanges and 12 overpasses/underpasses. The works that will be performed in the section Demir Kapija – Smokvica are comprised of: road works, tunnel civil works, bridge works, overpasses, underpasses, junctions, associated auxiliary and temporary works including service roads, access roads, landscaping.

In this paper, the methodology of risk assessment, risk assessment and control measures for activities associated with construction of bridge on the motorway section Demir Kapija - Smokvica are presented.

### THE RISK ASSESSMENT METHODOLOGY

Team of professionals in the field of safety of work from the Faculty of Technical Sciences Bitola prepared risk assessment for the whole project, [1]. The risk assessment is made in accordance with the Law on safety and health at work, [3] and Rulebook on minimal requirements related to safety and health at work for temporary or mobile construction sites [4]. The recognition and identification of risks and hazards in the workplace is made on the basis of data gathered from documents available to the Employer, observation and monitoring of the process at work in the workplace, gathering the necessary information and staff information and other sources. The Risk Assessment methodology presented in this paper is comprised of four levels

- HAZARD IDENTIFICATION

At the first level, for each construction activity, a method statement has to be developed. Based on the method statement potential hazards are identified.

- RISK ASSESSMENT

After having identified the hazards we calculate the risk per hazard. This calculation can be a qualitative or quantitative or both, if practicable. It is proposed that the occupational risk assessment is calculated qualitative, but without excluding other forms of similar competence. According to the Risk Assessment methodology each activity is broken down to tasks, it considers the hazards associated with each task and assesses the risk by assessing the likelihood of an event of a particular severity to occur and multiplies this likelihood with the corresponding severity (see sample risk assessment in the next page). Always the worst case scenario is considered.

The Severity is specified qualitatively by setting classification criteria which determine how serious the impact of a hazard is. Severity is rated into five levels as shown in Table 1. The assessment of the likelihood of a risk is made by using Table 2. Table 3 is the Risk Matrix which incorporates the criteria for assessing the severity and the likelihood, and is an effective tool for assessing and presenting the risk that can be understood at all levels

- SAFETY MEASURES EVALUATION

Completing a risk assessment with safety measures proposed, it is expected that the residual risk is trivial or minor. If this is not the case, then further measures are proposed.

- SAFETY MEASURES REVALUATION – REVISION

The final stage of the Risk Assessment is about reevaluating and revising the assessment depending on the nature of the Hazards and the various changes in the method statements.

**Table 1. Rating Severity**

Rating		Severity
1	Trivial	Trivial, minor first aid treatment. Back to work same day
2	Minor	Minor wounds, first aid treatment. Back to work within three days from incident
3	Moderate	First aid treatment. Hospital treatment. Back to work after 3 days from incident. No operation
4	Major	Hospital treatment. Operation is required. Back to work after 60 days from incident or requirement for changing post due to injury
5	Severe	Change work, Death

**Table 2. Rating Likelihood**

Rating		Likelihood
1	Almost zero	Impossible or almost impossible to happen
2	Low	The likelihood is very low
3	Possible	It is possible to happen
4	High	It is very likely to happen
5	Almost certain	It is almost certain or certain

$$\text{RISK} = \text{SEVERITY} \times \text{LIKELIHOOD}$$

**Table 3. Rating Risk Summary (see table 4)**

Assessment	Risk	Rating (Quantification)
Acceptable risk. No additional safety measures required.	Trivial	1 (1-2)
Acceptable risk. No additional safety measures required apart. A more close supervision and safety measures implementation might be required.	Minor	2 (3-5)
Not acceptable risk. Action is required. Measures should be fully implemented within a month.	Moderate	3 (6-8)
Not acceptable risk. Action is required. Measures should be fully implemented within a week.	Major	4 (9-14)
Not acceptable risk. Action is required. Works must be stopped Immediately Measures should be fully implemented immediately.	Severe	5 (15-25)

**Table 4.** Risk classification

Risk = Likelihood X Severity			Severity				
			Trivial	Minor	Moderate	Major	Severe
			1	2	3	4	5
Likelihood	Almost zero	1	1	2	3	4	5
	Low	2	2	4	6	8	10
	Possible	3	3	6	9	12	15
	High	4	4	8	12	16	20
	Almost certain	5	5	10	15	20	25

### RISK ASSESSMENT FOR THE BRIDGE B6

Before analyzing the major risks associated with bridge construction, the main bridge construction methods should be known. The main bridge construction methods are: flasework method, incremental launching method and cantilever method, [6]. Because the activities related to constructing of high motorway bridges include many different civil works, activities on the identification of hazard and risk are relatively difficult. Generic risks during construction of a highway bridge can be found in the literature related to this area. Due to pages limitations, in this article only an excerpt from the detailed risks assessment for the construction of bridge B6 is given in Table 5.

**Table 5.** Excerpt from the detailed risk assessment for construction of bridge B6

Activities/ work phases	Hazards	Risk	Risk severity	Safety Measures
General excavation of foundations	Earthworks	Collision / crushing / fall (at deep excavations)	<b>High</b>	Operator / Personnel experienced Trained personnel Use of PPE
	Confined space	Dust Reducing the depth of excavation, as above, it eliminates the risk in the closed space	<b>Low</b>	The entry or exit from the pit must become with the use of appropriate ladder Remotion of personnel out of load path where it is possible The operator must have the proper licence The equipment must be equipped with reverse alarm that is working Assistance by an operator for the equipment movements Personnel with no executed wok must draw away from the area The vehicles activities must be at safety distance from the edge of pit In areas of pits that no works executed must be safety closed

				Spraying with water in case of dust Create different points of access and egress and fencing of the construction zone of the pedestals
Unstable seat Lack of adequate space Pre-existing aerial networks Scroll bunding Flood / flooding project	Proper mounting of the machinery  Safe distance the boom from overhead networks	<b>Low</b>  <b>High</b>		Presence Geotechnical / Geologists during manufacture qualified staff Appropriate equipment
Use of construction equipment	Collision, crushing, tipping over	<b>High</b>		Before starting works with heavy equipment ensure the soil condition is good The equipment must be equipped with reverse alarm that is working Operator / Personnel experienced, careful and licensed
Use of electrical tools	Workers electrocution	<b>High</b>		The tools shall be insulated, earthed and with undamaged wire Working floor without water
Exposure to harmful factors	Solar radiation  Noise / vibration / shocks Dust  Outdoor /work-frost  Outdoor work-heat	<b>Medium</b>  <b>High</b>  <b>Medium</b>  <b>High</b>  <b>Medium</b>		Use of up to date and well maintained equipment for reduced noise production Shock – absorbing handles Continuous impregnation treatment for dust Controlled operations during frost and heat Personal Protection
Manual load handling	Musculoskeletal conditions	<b>Medium</b>		25 kg of load per worker training for the safe load lift and transportation mechanical load handling

<b>Assembling - disassembly scaffolding / formwork</b> <b>Assembling - disassembly metal body bridging</b>	Dangers of construction equipment /lifting works	Load lift / collision  Hand tools	<b>High</b>  <b>Low</b>	Operator / Personnel experienced and careful Trained personnel Use of PPE Remotion of personnel out of load path where it is possible Optic contact during transport or guide help Safety load binding The operator must have the proper licence Before starting works with heavy equipment ensure the soil condition is good Personal Protection
	Falls from height	Gaps in scaffolds Subversion. failure assembly Subversion. bearing failure Collapse	<b>High</b> <b>High</b> <b>High</b> <b>High</b>	Tying tools Avoid storing materials in floor scaffolding Safe tying to transfer items Personal Protection Use certified scaffolding Applicability - Compliance studies scaffolding (if required) Adequate support (fixed seating etc) - complete flooring work Measures against overturning
	Exposure to harmful factors	Solar radiation Noise / vibration Dust Outdoor work - frost  Outdoor work - heat	<b>Medium</b> <b>Low</b> <b>Medium</b> <b>Low</b>  <b>Medium</b>	Continuous wetting the road to avoid The dust Controlled operations during frost and heat Personal Protection
<b>Concrete works (concreting piers / walls /abutments / retaining walls)</b>	Dangers of construction equipment	Vehicle crash Vehicle collisions - people Vehicle crashes - fixed obstacle Crush between vehicle - machine Crush between vehicle - fixed obstacle Uncontrolled movement. system failures Uncontrolled movement. incomplete immobilization	<b>Medium</b> <b>High</b> <b>Medium</b> <b>Medium</b>  <b>Low</b>  <b>Low</b>  <b>Low</b>	Check fencing Fixed seating machine appropriate signage Accompanying documents (licenses & insurances operator / machine, authorization) Prohibition overload vehicles - machinery The machines will be equipped with beacon and reversing beep keeping driving code Proper maintenance machinery (Technical Manual) Personal Protection

		unstable seat Lack of space Construction Tools	<b>Low</b>	
	Falls from height	Gaps on floors Lack of ends on the flooring Elevated paths and footbridges Mobiles Ladders Suspended floors. Failure suspension Gaps in scaffolds Subversion. Failure assembly Subversion. Bearing failure Collapse. Failure material of the scaffold	<b>High</b> <b>High</b> <b>High</b> <b>High</b> <b>High</b> <b>High</b> <b>High</b> <b>High</b>	Personal Protection tying tools Safe tying tools to carry items Assembly and use of mobile and fixed scaffolding in accordance with regulations Adequate support (fixed seating etc) - complete flooring work Measures against overturning (eg anchorage fixed point) Fencing - Labeling of working area availability pharmacy avoiding overload

The conducted risk assessment is part of the total H&S plan implemented by the Contractor which also involves permanent health and safety related campaigns, on-site trainings and education of the staff, [2].

## CONCLUSION

Construction of high motorway bridge is one of the activities with highest hazards. In order to reduce the hazards, emergency procedures are developed and workers are adviced to strictly follow these procedures accompanied by control measures. Some of these control measures are [5]:

- All work surfaces should be properly installed in order to prevent their collapse/breakage, and to prevent people or objects falling out of them; they as well as all cavities and openings, must be securely fenced safe and stable positioning of ladders is a must; all open pits, in the field and in the work areas must be safely fenced;
- Wearing of safety-shoes with non-slip soles; it is also possible to roughen (by various techniques) all or some of the work surfaces;
- All means for preventing worker injury should be applied prior to and during excavation, as well as before carrying out demolition works, if required; compliance with the specific regulations dealing with excavation is a must;
- Usage of personal protection equipment fit for protecting the whole body, inc. crashhelmets, safety shoes and goggles;
- Work surfaces, floors, footpaths and similar passages must be free from protruding nails, binding wires, and all other obstacles;
- Work clothes have to be fitted to the climatic conditions; in order to prevent dehydration, all workers should drink enough water; use gloves and safety clothes according to need;
- Wear safety shoes that have inherent isolation, and do not work with detective tools
- Use appropriate clothing and head covers, for protection against inconvenient climatic conditions, inc. solar radiation;
- When necessary, consult with an ergonomist and/or environmental engineer and
- When working over water, the employer is required to provide employees with approved life jackets.

Handling and storing materials involves diverse operations such as hoisting tons of steel or concrete with a crane. It is important to know the rated capacity of cranes and rigging equipment to prevent overloading conditions.

- Cranes must be inspected frequently by people thoroughly familiar with the crane.
- If slings are used, they must be visually inspected before use and during operation. Defective equipment must be removed from service.
- Hoisting routes that minimize the exposure of employees to hoisted loads must be used.
- Materials must be rigged by a qualified rigger.
- Materials being hoisted must be rigged to prevent unintentional displacement.
- A tag or restrain line must be used if necessary to prevent rotation of the load that would be hazardous.
- Where a signal person is required, the type of signals must be established and understood by the crane operator, signal person and lift supervisor.

## REFERENCES

- [1] Geramitcioski T., Mitrevski V., Mijakovski V., Risk assessment with concept of safety and health at work for AKTOR S.A., Faculty of Technical Sciences, Bitola, March 2013.
- [2] Project health safety security management system (P-HSS MS) – Level 0 to 3, Agency of state roads of Republic of Macedonia, AKTOR S.A., HSS Management Force Group, November 2012.
- [3] Law on safety and health at work, Official gazette of Republic of Macedonia No. 92/2007.
- [4] Rulebook on minimal requirements related to safety and health at work for temporary or mobile construction sites, Official gazette of Republic of Macedonia No. 105/2008.
- [5] [www.ilo.org](http://www.ilo.org)
- [6] [www.mapfre.com](http://www.mapfre.com)



## RISK ASSESSMENT AT MOTORWAY TUNNEL CONSTRUCTION

Vladimir Mijakovski, Tale Geramitcioski, Vangelce Mitrevski

<sup>1</sup>University “St. Kliment Ohridski”, Faculty of Technical Sciences, Bitola, FYR Macedonia  
e-mail: [vladimir.mijakovski@tfb.uklo.edu.mk](mailto:vladimir.mijakovski@tfb.uklo.edu.mk)

**Abstract:** The subject of this paper is to give a brief overview of the risk assessment for the motorway tunnel as part of the risk assessment for the project comprising building of new motorway from the town of Demir Kapija down to the village of Smokvica, Republic of Macedonia. That is the last un-upgraded section of the existing motor road/motorway E-75, that runs through the Republic of Macedonia and connects Republic of Serbia and the Republic of Greece. Construction of the remaining section of this motorway will enable faster and more safe transportation of people and goods from Central Europe to Greece, or to Turkey and Near East since it will be connected to “Via Egnatia” (West-East) motorway in Greece. Team from the Faculty of Technical Sciences – Bitola prepared risk assessment for the whole project comprising 30 different work places and is constantly engaged as a consultant for Health and Safety at work related issues, [1]. According to identified risks (hazards) during tunneling road works, control measures are proposed in order to reduce or eliminate this risks.

**Key words:** risk assessment, motorway, tunnel

### INTRODUCTION

The motorway section is passing through the Demir Kapija canyon and the remaining gorge and through the more or less flat area from the village Miravci to the village Smokvica. The works that will be performed in the section Demir Kapija – Smokvica, can be seen in the project’s time schedule and comprise of:

- Road works
- Tunnel civil works
- Bridge works
- Overpasses
- Underpasses
- Junctions
- Associated auxiliary and temporary works including service roads, access roads, landscaping etc.

In total, the project involves construction of 28.2 km of new dual carriageway, including two twin tunnels of a total length of 4.5 km, 6 major river bridges/viaducts, 2 interchanges and 12 overpasses/underpasses. The main Contractor on the project is AKTOR S.A., the largest construction company in Greece.

Risk Assessment is a structured process to identify risks, assess risks and define safety measures or arrangements to remove/isolate or reduce risk as far as it is reasonably practicable and control residual risks..

### THE RISK ASSESSMENT METHODOLOGY

The Risk Assessment methodology presented in this paper is comprised of four levels, [2,3].

- HAZARD IDENTIFICATION

At the first level, for each construction activity, a method statement has to be developed. Based on the method statement potential hazards are identified.

- RISK ASSESSMENT

After having identified the hazards we calculate the risk per hazard. This calculation can be a qualitative or quantitative or both, if practicable. It is proposed that the occupational risk assessment is calculated qualitative, but without excluding other forms of similar competence.

According to the Risk Assessment methodology each activity is broken down to tasks, it considers the

hazards associated with each task and assesses the risk by assessing the likelihood of an event of a particular severity to occur and multiplies this likelihood with the corresponding severity (see sample risk assessment in the next page). Always the worst case scenario is considered.

The Severity is specified qualitatively by setting classification criteria which determine how serious the impact of a hazard is. Severity is rated into five levels as shown in Table 1

The assessment of the likelihood of a risk is made by using Table 2

Table 3 is the Risk Matrix which incorporates the criteria for assessing the severity and the likelihood, and is an effective tool for assessing and presenting the risk that can be understood at all levels

- SAFETY MEASURES EVALUATION

Completing a risk assessment with safety measures proposed, it is expected that the residual risk is trivial or minor. If this is not the case, then further measures are proposed.

- SAFETY MEASURES REVALUATION – REVISION

The final stage of the Risk Assessment is about reevaluating and revising the assessment depending on the nature of the Hazards and the various changes in the method statements.

**Table 1. Rating Severity**

Rating		Severity
1	Trivial	Trivial, minor first aid treatment. Back to work same day
2	Minor	Minor wounds, first aid treatment. Back to work within three days from incident
3	Moderate	First aid treatment. Hospital treatment. Back to work after 3 days from incident. No operation
4	Major	Hospital treatment. Operation is required. Back to work after 60 days from incident or requirement for changing post due to injury
5	Severe	Change work, Death

**Table 2. Rating Likelihood**

Rating	Likelihood	
1	Almost zero	Impossible or almost impossible to happen
2	Low	The likelihood is very low
3	Possible	It is possible to happen
4	High	It is very likely to happen
5	Almost certain	It is almost certain or certain

**RISK = SEVERITY x LIKELIHOOD**

**Table 3. Rating Risk Summary (see table 4)**

Assessment	Risk	Rating (Quantification)
<b>Acceptable risk. No additional safety measures required.</b>	<b>Trivial</b>	<b>1 (1-2)</b>
Acceptable risk. No additional safety measures required apart. A more close supervision and safety measures implementation might be required.	Minor	2 (3-5)
Not acceptable risk. Action is required. Measures should be fully implemented within a month.	Moderate	3 (6-8)
Not acceptable risk. Action is required. Measures should be fully implemented within a week.	Major	4 (9-14)
Not acceptable risk. Action is required. Works must be stopped Immediately Measures should be fully implemented immediately.	Severe	5 (15-25)

**Table 4.** Risk classification

Risk = Likelihood X Severity			Severity				
			Trivial	Minor	Moderate	Major	Severe
			1	2	3	4	5
Likelihood	Almost zero	1	1	2	3	4	5
	Low	2	2	4	6	8	10
	Possible	3	3	6	9	12	15
	High	4	4	8	12	16	20
	Almost certain	5	5	10	15	20	25

### RISK ASSESSMENT FOR THE TUNNEL T1

Construction of the tunnels is done according to NATM (New Austrian Tunneling Method) in two stages. First, the upper part of the portal is drilled, blasted and the remaining material from blasting is removed by excavation. After that, the same procedure applies for the lower part of the tunnel. Next phase is shotcreting with wet concrete followed by installation of lighting fixtures. After this phase, prior to formworks and final concreting works on the tunnel's arches, pedestrian pathways are constructed. Final stage of the tunnel construction are finishing roadworks.

As described above, tunneling works include many different civil works activities (surveying, excavation, drilling, charging, blasting, etc...), hence identification and assessment of risks was relatively difficult. Due to pages limitations, in this article only an excerpt from the detailed risk assessment for the construction of tunnel T1 is given in Table 5.

**Table 5.** Excerpt from the detailed risk assessment for construction of tunnel T1

Activity / operation	Health & Safety (HS) and Environmental (E) risks	Risk severity	Protective Measures	Technical or Organizational Measures for the Control of the Remaining Risk
Surveying works (setting out and leveling embankment)	Inability to call/ receive assistant due to lone working	H	<ul style="list-style-type: none"> <li>Always works in pairs</li> <li>Always before working in isolated areas inform colleagues in the office about when expecting to finish work</li> </ul>	<ul style="list-style-type: none"> <li>Provide with an emergency phone at all times</li> <li>Provide with a first aid kit at all times</li> </ul>
	Heatstroke	M	<ul style="list-style-type: none"> <li>Workers to wear a safety Hat</li> <li>Drink water regularly</li> <li>Avoid short sleeves and dark colourless clothes</li> </ul>	
	Hit by equipment	H	<ul style="list-style-type: none"> <li>Licensed operator</li> <li>Properly maintained</li> <li>Audio and visual reverse alarm</li> <li>Clear manoeuvring area</li> <li>All stay at least 5 meters away from working area of equipment</li> </ul>	<ul style="list-style-type: none"> <li>Provide to a person to regulate plant traffic locally</li> <li>Stop all equipment within the measurements area</li> <li>Wear high visibility vest all times</li> <li>Wear safety helmets and boots</li> </ul>

<b>Installation of corrugated polypropylene pipes</b>	Manual handling Injury	M	<ul style="list-style-type: none"> <li>• <b>Handle heavy materials/elements in pairs.</b></li> <li>• <b>Use mechanical means</b></li> </ul>	<ul style="list-style-type: none"> <li>• Personal protection (PPE)</li> </ul>
	Load falls off  /lifting tackle (gear) fails	H	<ul style="list-style-type: none"> <li>• <b>Licensed operator</b></li> <li>• <b>Fixed lifting points</b></li> <li>• <b>Experienced rigger</b></li> <li>• <b>Check the load before lifting</b></li> <li>• <b>Proper lifting tackle in perfect condition</b></li> <li>• <b>Lifting gear capacity check and in consistence in between them</b></li> <li>• <b>Inspect before use</b></li> <li>• <b>Continuous supervision</b></li> <li>• <b>Clear travel road</b></li> <li>• Clear vision of load by the operator, otherwise an experienced signaller should be in place</li> </ul>	<ul style="list-style-type: none"> <li>• Loading procedures</li> <li>• Fasten load tightly and secure it</li> </ul>
<b>Mechanically transporting materials (placement of embankment material)</b>	Material falling of the truck	H	<ul style="list-style-type: none"> <li>• Licensed driver</li> <li>• Driver in good condition</li> <li>• Load to be checked before leaving</li> <li>• Never overload the truck</li> <li>• Vehicle properly maintained and in good condition (lights, brakes, reverse alarms, tyres).</li> <li>• Door and hatches to be locked during every truck movement</li> <li>• Construct adequate site roads and maintain them properly</li> </ul>	<ul style="list-style-type: none"> <li>• Loading procedures</li> <li>• Fasten load tightly and secure it</li> <li>• Fine materials to be covered at all times</li> </ul>
	Damage site utilities	H	<ul style="list-style-type: none"> <li>• Surfaces utilities to be mechanically protected</li> </ul>	
	Damage existing roads, structure, etc	M	<ul style="list-style-type: none"> <li>• Routes to be verified for suitability and capacity</li> <li>•</li> </ul>	
	Vehicular accident irrelevant of the road	H	<ul style="list-style-type: none"> <li>• License driver</li> <li>• Comply with traffic regulations</li> <li>• Vehicle in good condition</li> <li>• Levelled roads on site</li> <li>• Strict traffic rules on site</li> <li>• Check for height restrictions</li> </ul>	<ul style="list-style-type: none"> <li>• Consult with authorities for transporting material outside the site</li> </ul>
	vehicle diversion from the road		<ul style="list-style-type: none"> <li>• placement bilaterally of the road reinforced concrete new jerseys</li> </ul>	<ul style="list-style-type: none"> <li>• appropriate warning signs for drivers</li> <li>• speed limit</li> </ul>

	Truck overturning	H	<ul style="list-style-type: none"> <li>• Do not overload truck</li> <li>• Do not lift the skip if overloaded</li> <li>• Do not unload close to the embankment edges</li> <li>• Use the bulldozes to push the material towards the edges</li> </ul>	
	Fall off from heights	M	<ul style="list-style-type: none"> <li>• Safe access</li> <li>• Safe working area</li> </ul>	
	Hit by material	H	<ul style="list-style-type: none"> <li>• Unloaded area to be supervised at all times</li> <li>• Door and hatches to be unlocked just before unloading and from the site</li> </ul>	
	Falling objects	M	<ul style="list-style-type: none"> <li>• Do not have people underneath the operations</li> </ul>	<ul style="list-style-type: none"> <li>• Trained employees on Health and Safety issues</li> <li>• Personal protection (PPE)</li> </ul>

It should be noted that the conducted risk assessment is only part of the total H&S plan implemented by the Contractor which also involves permanent health and safety related campaigns, on-site trainings and education of the staff. This is followed by regular measurement of noise, lighting, toxic gases and flammable gases in the tunnels, especially before/after blasting works, complying to local and EU legislative, [4, 5 and 6].

## CONCLUSION

Construction is one of the industries with highest hazards. Risk assessment methodology applied for tunneling works follows the construction process. Construction of road tunnels, apart from typical construction works hazards, involves many non-typical types of risks, such as oxygen deprivation, work in toxic and flammable atmosphere and exposure to dust due to working machinery or after blasting. In order to reduce the hazards, emergency procedures are developed and workers are advised to strictly follow these procedures accompanied by control measures. Some of these measures are:

- Performing of air monitoring and provision of proper ventilation. If oxygen level drops below 19 percent, works must be halted and additional ventilation must be enforced;
- Tunnel atmosphere to be constantly monitored during work. Workers to be trained in the use of monitoring equipment and evacuation procedures;
- Rescue equipment to be provided and all workers to wear safety harnesses, helmets and protective clothing;
- Measure and monitor the levels of O<sub>2</sub> and toxic gases. Use breathing apparatus if necessary. Provide sufficient ventilation;
- Workers to be trained in the hazards of operating in confined spaces. Workers to be trained in the use of rescue equipment and gas detection equipment. Locate the position of the fire extinguishers and in a case of emergency be ready to use them;
- Always use the routes provided for pedestrians and avoid using the route used by vehicles and equipment. Always wear the high visibility vest when working in the tunnel;
- Pay attention for falling debris when working in areas that have not been secured with proper temporary or permanent support. Proper lighting will be throughout the length of the tunnel and especially in the areas where work is being performed;
- Use ear protection, especially when working at the head of the tunnel, where the machinery operates;
- Where dust is likely to be a hazard to health, suitable Personal Protective Equipment (PPE) – breathing apparatus **MUST BE PROVIDED AND WORN.**

## REFERENCES

- [1] Geramitcioski T., Mitrevski V., Mijakovski V., Risk assessment with concept of safety and health at work for AKTOR S.A., Faculty of Technical Sciences, Bitola, march 2013.
- [2] Project health safety security management system (P-HSS MS) – Level 0 to 3, Agency of state roads of Republic of Macedonia, AKTOR S.A., HSS Management Force Group, November 2012.
- [3] Ceric A., Marcic D., Ivandic K., A risk-assessment methodology in tunneling, Tehnicki vjesnik 18, 4, pp.529-536, 2011.
- [4] Law on safety and health at work, Official gazette of Republic of Macedonia No. 92/2007.
- [5] Rulebook on minimal requirements related to safety and health at work for temporary or mobile construction sites, Official gazette of Republic of Macedonia No. 105/2008.
- [6] Rulebook on minimal requirements related to safety and health at work for mineral extracting industries (drilling), Official gazette of Republic of Macedonia No. 163/2011.

## TUNNELS AS AN AIR POLLUTANT ON DEMIR KAPIJA – SMOKVICA MOTORWAY CONSTRUCTION

Tale Geramitchioski, Vangelche Mitrevski, Vladimir Mijakovski

<sup>1</sup>University St. Kliment Ohridski, Technical Faculty, Bitola, FYR Macedonia  
e-mail: tale.geramitchioski@uklo.edu.mk

**Abstract:** This paper presents the results of the impact of gases on environment as a result of blasting in the tunnels which is part of the construction area in the project E-75 Motorway section Demir Kapija – Smokvica. Measured values of gases CO, CO<sub>2</sub>, NO, NO<sub>2</sub>, NO<sub>x</sub>, after blasting are very high, and with a very high impact on the environment. So, several constructive solutions to decrease the influence on the environment are given in the paper.

**Key words:** tunnels, air pollutant, environment

### INTRODUCTION

Air is necessary for the survival of living beings. It is a “gas-shell” of the Earth that comprises mostly nitrogen 78%, oxygen 21%, argon 1% and about 0.03% of carbon dioxide. Besides the composition of the atmosphere, it contains certain amount of water vapor and tiny particles of dust cover, aerosols whose dimensions are in the order of 10<sup>-5</sup> to 10<sup>-7</sup> cm, then internal gases (neon, argon, helium, krypton and xenon), fog, pores, smoke, carbon monoxide and various other organic compounds. Only anaerobic microorganisms are able to live without air or oxygen. Without food a man can stand for about 5 weeks, 5 days without water and without air only about 5 minutes. Preserving the oxygen balance is vital for humans and life on Earth, in general. This stems from the fact that every year on account of the destruction of oxygen, poisonous carbon dioxide thrown in the atmosphere is increasing. Clean air can be found only in remote areas that are not inhabited by humans. In addition to nitrogen, oxygen, argon, carbon dioxide and internal gases, traces of CH<sub>4</sub>, O<sub>3</sub>, CO and NH<sub>3</sub> can be found in the air. They originate from the higher parts of the atmosphere or are generated during the decomposition of organic matter or as a result of the impact of weather changing conditions. Pollutants change the Earth's atmosphere by allowing more and more harmful radiation from the sun. At the same time, polluted atmosphere becomes even better insulator, capturing the heat near the surface and contributing to the increase of global average temperatures. Scientists warn that the growth temperature, in the form of global warming will affect food supply on global level and weather will become more extreme and cause expanding of tropical belt.

Air pollution means introduction of new nonspecific physical, chemical and biological substances in the air or changes of the already high concentrations of these substances in the environment. Air pollutant is any substance that can cause harm to humans and the environment. Pollutants can be in the form of solid particles, liquid droplets or gases. Moreover, they can be of natural or man-made origin. Pollutants may be classified as primary or secondary. Usually, primary pollutants are directly emitted from a given process, such as ash from volcanic eruptions, carbon monoxide from discharges of motor vehicles or sulfur dioxide released from factories. Secondary pollutants are not emitted directly, but are created in the air by reactions or interactions between primary pollutants. An important example of a secondary pollutant is ground ozone - one of the many secondary pollutants that are an integral part of photochemical smog. Some pollutants may be both primary and secondary, if emitted directly or create other primary pollutants.

Republic of Macedonia, as a candidate country for EU-membership must comply with all European directives on environmental protection. Thus, large motorway construction of section Demir Kapija - Smokvica is a relevant source of pollution that needs to be analyzed and taken appropriate guidance for further actions to reduce environmental impact

## MATERIAL AND METHODS

Subsidiary of Actor ADT - Greece in Macedonia is the main contractor building the rest of the Motorway A-1 (E-75) from Demir Kapija to Smokvica, with a length of 28 km, as part of the Pan-European Corridor X, on the level of highway with permissible speed of 120 km/h. Construction of the highway section, among other things will include construction/drilling of 2 tunnels with a total length of over 4,5 km, and 6 bridges with a total length of 1,7 km. The execution of works, causes great disorder in eco balance, because most of the construction machines and systems are generators of dust, toxic gases CO and CO<sub>2</sub>, NO<sub>2</sub>H, high levels of noise and vibration that significantly affect the eco system nearby.

### Air pollutants

The basic primary air pollutants that occur:

- Sulfur oxides (SO<sub>x</sub>) - especially sulfur dioxide, a chemical compound with the formula SO<sub>2</sub>. SO<sub>2</sub> is produced by volcanoes and by various industrial processes. Since coal and petroleum often contain sulfur compounds, their combustion produces sulfur dioxide. With further oxidation of SO<sub>2</sub> (usually in the presence of a catalyst such as NO<sub>2</sub>) sulfuric acid (H<sub>2</sub>SO<sub>4</sub>) is formed, main component of acid rains. This is one of the reasons for concern when utilizing these type of fuels.
- Nitrogen oxides (NO<sub>x</sub>) - especially nitrogen dioxide are emitted during the combustion at high temperatures. It can be seen in the form of brown haze over cities.
- Carbon monoxide (CO) - a colorless, odorless and non-irritation but very poisonous gas. It is a product of incomplete combustion of fuels such as natural gas, coal or wood. The outlet of the vehicles is a major source of carbon monoxide.
- Carbon dioxide (CO<sub>2</sub>) - a colorless, odorless and non-toxic greenhouse gas associated with ocean acidification, emitted during combustion, cement production, and respiration. Otherwise it is recycled into the atmosphere through the carbon cycle.
- Persistent free radicals connected to airborne fine particles could cause cardiopulmonary diseases, [4], [5].
- Toxic (heavy) metals (Pb, Cu, Zn, Cd, Cr).
- Chlorofluorocarbons (CFC's) - harmful to the ozone layer and are emitted from products currently banned for use.
- Ammonia (NH<sub>3</sub>) - emitted during agricultural processes. In nature, it is encountered as a gas with a characteristic strong odor. Ammonia serves as a precursor for the fertilizer. Directly or indirectly, ammonia is also a main component of many pharmaceutical substances. Although widely used, it is caustic and hazardous.
- Odors - such as from garbage, sewage, and industrial processes.
- Radioactive pollutants - produced by nuclear explosions, nuclear events, war explosives, and natural processes such as radioactive decay of radon.

### Tunnels T1 and T2 - Air pollutant in construction of motorway Demir Kapija- Smokvica

In the project, construction of tunnel T1 (left and right bore) in total length of 2,2 km is planned. (Fig. 1).





**Figure 1.** Tunnels T1 (T2) as primary sources of air pollution on site  
Tunnels are drilled with multiple methods of blasting of rocky material (fig. 2 and 2b) (strictly controlled explosions) and drilling with machinery (such as fig. 1b).



**Figure 2.** a) explosive used with controlled charges b) stacking of dynamite

When performing structural works on the tunnel, with very frequent controlled explosions, as a by-product gases CO, CO<sub>2</sub>, NO<sub>2</sub> and NO<sub>x</sub> occur. It is clear that these gases affect natural world and the nature of the surrounding area of tunnels. It is necessary to perform measurements and compare the measured values with permissible limits, in order to assess the situation on the basis of comparison and to provide recommendations and guidance on further action for protection of the environment.

## RESULTS AND DISCUSSION

Measured values and limits of the relevant components of the air pollutants as a result of the blasting in tunnels are given below:



**Figure 3.** Measurements of gases after the explosion at the face of  
a) tunnel T1 – left bore b) tunnel T1 – right bore

Exposure limits %	O <sub>2</sub> Health Effects / ΟΞΥΓΟΝΟ
20,9	Percentage of oxygen found in normal air. No effect.
19.5	Minimum permissible oxygen level. No effect.
15-19	Decreased ability to work strenuously. May impair coordination and may induce early symptoms with individuals that have coronary, pulmonary, or circulatory problems.
12-15	Respiration and pulse increase; impaired coordination, perception, and judgment occurs.
10 -12	Respiration further increases in rate and depth; poor judgment and bluish lips occur
8-10	Symptoms include mental failure, fainting, unconsciousness, an ash-colored-face, blue lips, nausea, and vomiting.
6-8	8 minutes - 100 percent fatal; 6 minutes - 50 percent fatal; 4-5 minutes - recovery with treatment.
4-6	Coma in 40 seconds, convulsions, respiration ceases - death.

20.9-23.5 percent: Maximum permissible oxygen level. No effect.

Exposure limits (ppm)		CO Health Effects / ΜΟΝΟΞΕΙΔΙΟ
PPM	Time	Comments
35 - 50	8 hours	The maximum allowable concentration For continuous exposure in any 8 hour period
200	2 - 3 hrs.	Headache (mild)
400	1 - 2 hrs.	Headache (mild)
800	10 - 15 min.	Dizziness, nausea
1600	20 min.	Headache, dizziness, death within 1 hour
3200	5 - 10 min.	Headache, dizziness, death within 1 hour
6400	1 - 2 min.	Headache, dizziness, death within 1 hour
6000 - 8000	5 min.	Incapacitation
12,800	2 - 3 min.	Unconsciousness breaths
12,800	1 - 3 min.	Death

Exposure limits (ppm)	CO <sub>2</sub> Health Effects / ΔΙΟΞΕΙΔΙΟ
1-3	Shortness of breath, deep breathing
5	Breathing becomes heavy, sweating, pulse quickens
7,5	Headaches, dizziness, restlessness, breathlessness, increased heart rate and blood pressure, visual distortion
10	Impaired hearing, nausea, vomiting, loss of consciousness
30	Coma, convulsions, death

Figure 4. Tables of allowed (limited) values of measured gases O<sub>2</sub>, CO, CO<sub>2</sub>

Dust measurements (particulate matter in the air) are performed with manual dust detector DUSTMATE, product of TurnKey, UK. Instrument has nefelometer with pump sucking air, while dust is measured using a laser. The instrument has its own memory (logger) to record data.

5. GAS MEASUREMENTS IN THE TUNNEL T1 - LEFT BRANCH				
GASES	DATE/TIME	MEASUREMENTS	NORMAL LIMITS	REMARKS
SO <sub>2</sub>	11.4.2013 14:50 a.m.	5 ppm (13.1 microgram/m <sup>3</sup> )	150 micrograms/m <sup>3</sup>	LESS than limit value
CO		70 ppm (85 mg/m <sup>3</sup> )	1 microgram/m <sup>3</sup> (50ppm)	MORE than limit value
NO <sub>2</sub>		20 ppm (24.4 microgram/m <sup>3</sup> )	85 microgram/m <sup>3</sup>	
NO		27 microgram/m <sup>3</sup>	0,01 % (mg/l)tV	
CO <sub>2</sub>		200 ppm (360 mg/m <sup>3</sup> )	0,5 % (5000 ppm)	LESS than limit value
CH <sub>4</sub>		0	1,0 % (10000 ppm)	
H <sub>2</sub> S		0	0,0005 % (5 ppm)	
O <sub>2</sub>		20,9		Normal
PM <sub>10</sub> DUST		6527 microgram/m <sup>3</sup>	120 microgram/m <sup>3</sup>	MORE than limit value

In the case of tunnels, as effective means of reducing the emission of harmful gases into the air as a result of the blasts is the use of filters (Fig.3) - gases containing dust pass through a porous medium made of woven or filler material. Particles in the gas are retained in the filters while the clean gas that is released from the particles in the system remains tight.



**Figure 5.** Textile filters (in the tube) remove and filtrate gases from the tunnel

**Table 2.** Measured values of suspended particulate matter (PM10) in the air by filtering

No.	Measuring point	measured value [ $\mu\text{g}/\text{m}^3$ ]	Permissible value [ $\mu\text{g}/\text{m}^3$ ]	Note
1.	Measuring points – left branch	834.1	50	unsatisfactory
2.	Measuring points – right branch	917.8	50	unsatisfactory



**Figure 6.** Measured values of the dust exiting left and right bore of tunnel T1 with filtering of air pollutants

The huge number of air pollutants result in many effects on man and the environment alike:

- Psychological effects - taking into account the wide range of known and yet unknown direct and indirect effects of atmospheric pollutants, it is quite likely that the estimated health and economic impact of pollution is lower than the real one.
- Reduction of visibility - leading to disturbances in air traffic and the opportunities for increased traumatism and losses in tourism .
- Action (damage) of materials - solid and liquid materials deposited on surfaces lead to:
  - Direct damage ( mechanical and chemical sulfide)

- Indirect damage, when certain chemical compounds are converted to other more harmful (SO<sub>2</sub> into H<sub>2</sub>SO<sub>4</sub> which can further be transformed to acid rain having harmful effects on the skin).
- Effect on plants – just to mention three main symptoms of harmful impact of pollutants (in particular SO<sub>2</sub>, fluridite, ozone, ethylene, nitrogen oxides, halogens, acids and some metals).
- failure of the structure of the leaves;
- chlorosis or other changes in color;
- Change of growth;
- Effects on animals - during acute episodes of atmospheric pollution and illness of the animals. Exposure of animals to air pollution is done either through inhalation or through contaminated pastures. It is proved that it can lead to a decline in milk production at exposed cows.
- Disruption of comfort - an important effect in terms of caring for the mental health of the population, but it is difficult to assess its real impact since this is pretty subjective category.

## CONCLUSION

The measured values of gaseous pollutants in early stages of tunnels construction works showed values much higher than the permissible given in the norms and standards. The amount of dust in the air also reached alarming values. As a first measure, the usage of textile tubular filter with vacuum allows gases and dust to exit the tunnel, while keeping the hard particles using electrostatic filters, and combined washing solutions which keep harmful gases ‘trapped’ in the water.

After constructive intervention, the measured values have decreased, but not enough to declare that air pollution around the constructive site is within the permissible levels.

So, in the future, much more activities must be undertaken in order to make complex and extensive study of possible technical and technological measures and solutions for greater reduction of harmful pollutants in the air.

## REFERENCES

- [1] Geramitcioski T., Mitrevski V., Mijakovski V., Risk assessment with concept of safety and health at work for AKTOR S.A., Faculty of Technical Sciences, Bitola, march 2013.
- [2] Project health safety security management system (P-HSS MS) – Level 0 to 3, Agency of state roads of Republic of Macedonia, AKTOR S.A., HSS Management Force Group, November 2012.
- [3] Maystre, Lucien Y., Spiegel, Jerry, Environmental Pollution Control, *Maystre, Lucien Y., Spiegel, Jerry, Editor*, Encyclopedia of Occupational Health and Safety, Jeanne Mager Stellman, Editor-in-Chief. International Labor Organization, Geneva. © 2011.
- [4] Elias, John, Environmental Pollution Control, Maystre, Lucien Y., Spiegel, Jerry, Editor, Encyclopedia of Occupational Health and Safety, Jeanne Mager Stellman, Editor-in-Chief. International Labor Organization, Geneva. © 2011.
- [5] Dr Zhou Yingxin, Construction Safety in Hard rock Tunnelling, Programme Manager (Underground Technology & Rock Engineering) Defence Science & Technology Agency, Washington, 2009
- [6] [http://www.ilo.org/oshenc/part-vii/environmental-pollution-control/item/510-air-pollution-control#EPC\\_table12](http://www.ilo.org/oshenc/part-vii/environmental-pollution-control/item/510-air-pollution-control#EPC_table12)
- [7] <http://www.ilo.org/oshenc/part-vii/environmental-pollution-control/item/511-water-pollution-control>
- [8] <http://www.pollutionsystems.com/air-pollution-systems.html>

## CALCULATION OF THE SHAFT SAFETY FACTOR USING STANDARD DIN 743 AND KISSsoft SOFTWARE

Aleksija Đurić, Biljana Maraković

University of East Sarajevo, Faculty of Mechanical Engineering East Sarajevo, B&H, RS

e-mail: [aleksijadjuric@gmail.com](mailto:aleksijadjuric@gmail.com); [biljamarkovic@yahoo.com](mailto:biljamarkovic@yahoo.com)

**Abstract:** This paper shows how to calculate the safety factor of the shaft using the KISSsoft software. Standard DIN 743 gives a new approach in calculations of the shafts and axles. This standard is very suitable for the development of programs that facilitate the calculation of safety factor of axles and shafts. The results obtained through the software KISSsoft will be compared with the results obtained from manual analytical calculation for the selected shaft.

**Key words:** DIN 743, KISSsoft, calculation, safety factor, shaft

### INTRODUCTION

Engineering praxis, as imperative, demands application of computer sciences in all phases of a product development process. The application of various softwares facilitates the design and allows the designer to come up with a solution quickly. Thus various programs, such as the KISSsoft software, allow a quick check of safety of shafts and axles.

Stress and strain analysis is one of the main tasks expected from design engineers to be fulfilled. Design is based on the theory of material strength and possibilities of materials properties usage. From the early beginnings of engineering era, engineers have been trying to get functional dependency between loads and dimensions of the elements. In most cases, there was a big uncertainty and complex mathematical dependency of several factors, and people started to use previously gathered knowledge and similarities. Engineers started to make probe tools that had familiar properties and behaviour, and later compared other manufactured parts with probe tool. That was the early beginning of the standards creation and progress in design theory, [9].

### STANDARD DIN 743

The German standard DIN 743 [1], [2], [3] has been prepared by the German Institute for standardisation and the Institute for Mechanical Elements and Design, Technical University of Dresden, Germany. The objective was to make a standard focusing on strength analysis of shafts and axles available for the engineering community. The standard is based on the standard TGL 19340 of Former German Democratic Republic, the VDI 2226 of Federal Republic of Germany and the FKM guideline compiled by the IMA Dresden, Germany.

The standard consists of four parts:

- Part 1: Introduction, analysis method (DIN 743-1)
- Part 2: Stress concentration factors and fatigue notch factors (DIN 743-2)
- Part 3: Materials data (DIN 743-3)
- Part 4: Examples

Standard DIN 743 involves equations for safety factor determination in critical sections of shafts and axles according to the two basic criteria:

1. Safety in relation to the plastic deformation of the part (static safety factor),
2. Safety in relation to the dynamical strength of the material (dynamic safety factor).

The scheme of calculation this two safety factor has been showed in *Figure 1*. Calculations include torque, pressure/tension and deflection of the shafts and axles. Shearing is not contained in the calculations. The results gained according to the DIN 743 clear any doubt about safety in critical sections of shafts and axles and meet demands of the engineers for successful, safer and complete dimensioning.

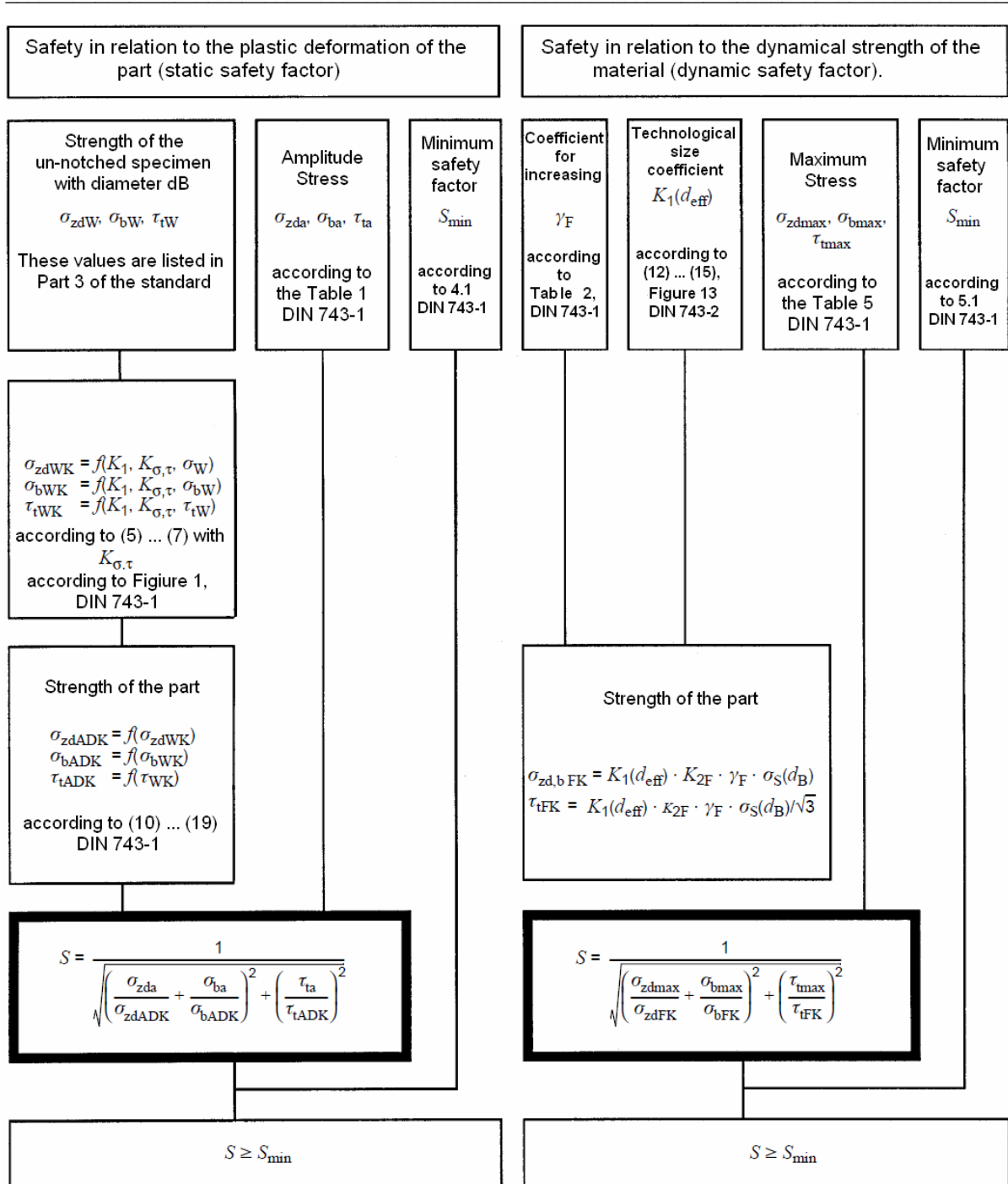


Figure 1. Scheme of calculation static and dynamic safety factors

Where:

- $\sigma_{zdFK}, \sigma_{bFK}, \tau_{tFK}$  - yield stress of material for pressure/tension, deflection and torque;
- $\sigma_{zdmax}, \sigma_{bmax}, \tau_{tmax}$  - maximal normal stress delivered by the pressure/tension, deflection and torque;
- $K_{2F}$  - factor of static strength;
- $\sigma_S(d_B)$  - yield stress of the probe (probe shaft);
- $K_1(d_{eff})$  - technological factor of the influence delivered by the size;
- $\gamma_F$  - factor of yield stress increase;
- $\sigma_{zda}, \sigma_{ba}, \tau_{ta}$  - amplitude stress delivered by the pressure/tension, deflection and torque;

$\sigma_{zdADK}, \sigma_{bdADK}, \tau_{tADK}$  - amplitude dynamical strength for the pressure/tension, deflection and torque;

$\sigma_{zdWK}, \sigma_{bdWK}, \tau_{tWK}$  - dynamic strength of the shaft;

$K_{\sigma, \tau}$  - factor of the surface roughness for normal/tangential stresses (according to Figure B.1 DIN 743-1);

$S \geq S_{min} = 1,2$  - minimal value of the safety factor.

## APPLICATION OF KISSsoft SOFTWARE FOR CHECKING SAFETY FACTOR OF SHAFTS

KISSsoft AG develops design software for engineers and designers in a wide variety of fields: whether they manufacture cable car systems, gears for construction equipment, Formula 1 race car transmissions or the tiny gears used in Mars rovers. More and more companies all over the world have come to rely on KISSsoft design software. When used in keeping up with currently valid standards (DIN, ISO, AGMA), this software serves as a quick, high-quality tool for sizing machine elements, reviewing calculations, determining component strength and documenting safety factors and product life parameters, [12].

The DIN 743 for strength analysis of shafts and axles is the most helpful analysis method, for analysis of machine elements provided by the KISSsoft software. The standard, however, is available in German only and the theory behind the KISSsoft software is not yet available for non-German speaking customers. Calculation of the axles and shafts according to the standard DIN 743 is a complex and iterative process requiring great number of iterative steps for solution searching. Usage of KISSsoft software accelerates and facilitates the calculation of axles and shafts

The central element of the shaft and bearing calculation is the graphic shaft entry (shaft editor). This is a place where the inner and outer geometry of the shaft, bearings, and loads are defined. Based on these data all relevant calculations can be executed from the elastic line and torque involutes, to critical speed, strength verification in accordance with DIN or FKM guidelines. A summarizing log provides an overview. The bearing calculation is integrated in the shaft calculation, so these dimensions, forces, etc. are already available.

### The analysis safety factor for the selected shaft

Firstly, it is necessary to define the outline of the shaft, supports, loads and critical points in the KISSsoft software (Figure 2).

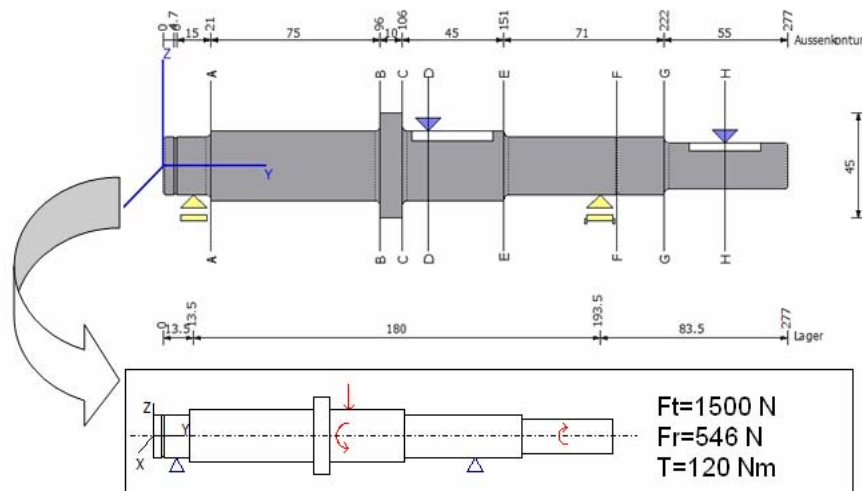
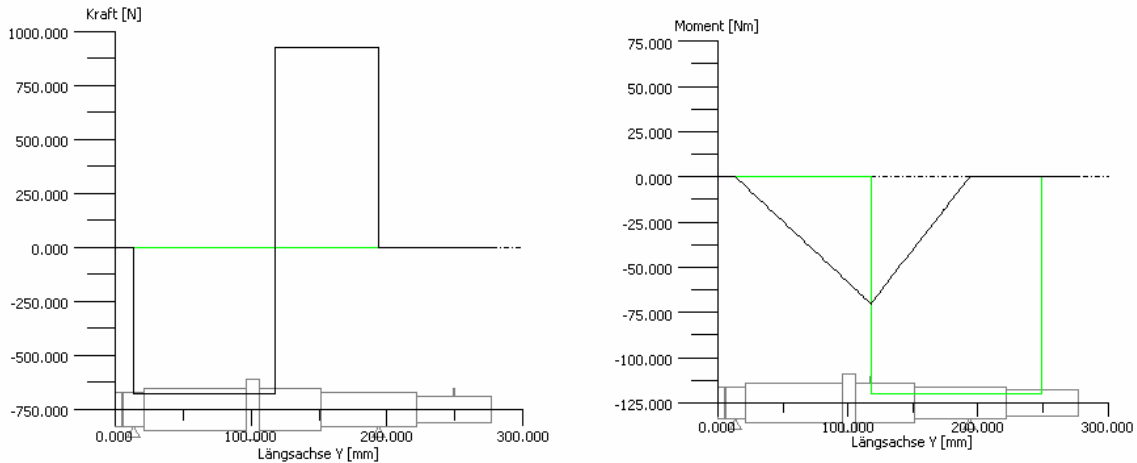


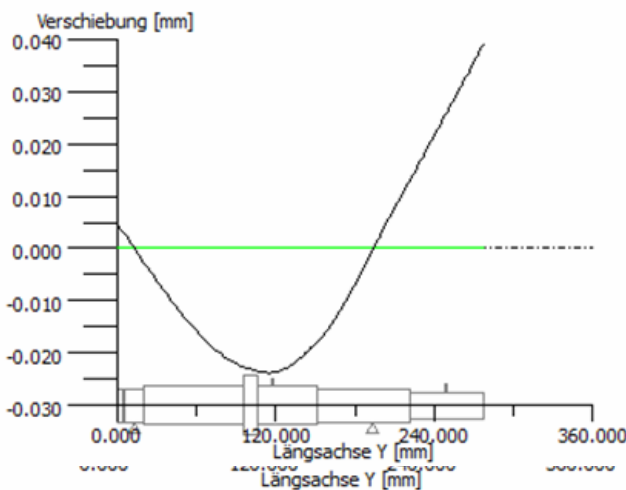
Figure 2. Model of selected shaft made in KISSsoft software

The first support is movable and the second is stationary. The first part of the shaft is only loaded by the bending, the middle part is loaded by bending and twisting, and the last part of the shaft is loaded only by twisting. The shaft material is a structural steel E295. It is necessary to notice the next facts: bending load is purely alternating variable load and twisting load is purely directional variable load. For these inputs the software provides a safety factor and draws diagrams that are suitable for the analysis of capacity shaft. *Figure 3* shows a diagram of the forces and moments obtained by this software.

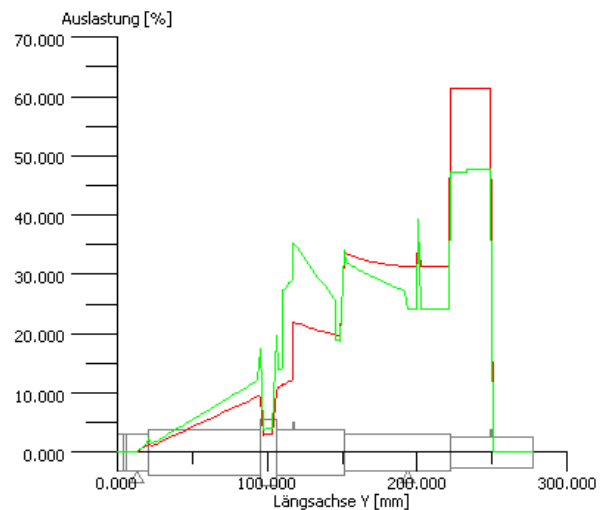


**Figure 3.** Diagram of the forces and moments

Moment diagram shows that the maximum moment on the shaft is equal to 70 Nm. KISSsoft also determines the reaction and movement of the supports, which has been used for drawing of the elastic line (*Figure 4*). *Figure 5* shows the load capacity of the shaft.



**Figure 4.** Elastic line of selected shaft



**Figure 5.** Diagram of shaft load capacity

Dynamic safety factors for critical points G and H (see Figure 2) obtained by the KISSsoft software are shown in *Table 1*. In *Table 1* also shows the factor and stresses that are required for safety factor calculation.



**Table 1.** Dynamic safety factor for critical points *G* and *H* obtained by KISSsoft software

Critical points	$T_{\tau a}$ [Nm]	$T_{\tau m}$ [Nm]	$\tau_{\tau a}$ [N/mm <sup>2</sup> ]	$\tau_{\tau m}$ [N/mm <sup>2</sup> ]	$\tau_{\tau W}(d_B)$ [N/mm <sup>2</sup> ]	$\beta_{\tau}$	$K_{\tau}$	$\tau_{bADK}$ [N/mm <sup>2</sup> ]	$S_D$
<i>G</i>	60	60	38,19	38,19	145	1,17	1,197	97,04	2,54
<i>H</i>			38,19	38,19		1,38	1,38	96,1	2,51

The cause of stress concentration on critical point *G* is transition radius, while the cause of stress concentration on critical point *H* is keyways. Static safety factor for critical points *G* and *H* is shown in *Table 2.*, also.

**Table 2.** Static safety factor for critical points *G* and *H* obtained by KISSsoft software

Critical points	$T_{\tau}$ [Nm]	$K$	$T_{\tau max}$ [Nm]	$\tau_{\tau max}$ [N/mm <sup>2</sup> ]	$\sigma_S(d_B)$ [N/mm <sup>2</sup> ]	$K_{2F\tau}$	$\gamma_{F\tau}$	$\tau_{\tau FK}$ [N/mm <sup>2</sup> ]	$S_F$
<i>G</i>	120	1,7	204	129,87	295	1,2	1	194,08	1,49
<i>H</i>				129,87		1,2	1	194,08	1,49

Both of safety factors are higher than the minimum level recommended in DIN 743. Dynamic safety factor is also manually calculated according to DIN 743. These results are shown in *Table 3* for critical points *G* and *H*. Results obtained by KISSsoft software and by manual calculation are compared in *Table 4.*

**Table 3.** Dynamic safety factor for critical points *G* and *H* obtained by manual calculation

Critical points	$T_{\tau a}$ [Nm]	$T_{\tau m}$ [Nm]	$\tau_{\tau a}$ [N/mm <sup>2</sup> ]	$\tau_{\tau m}$ [N/mm <sup>2</sup> ]	$\tau_{\tau W}(d_B)$ [N/mm <sup>2</sup> ]	$\beta_{\tau}$	$K_{\tau}$	$\tau_{bADK}$ [N/mm <sup>2</sup> ]	$S_D$
<i>G</i>	60	60	38,19	38,19	145	1,178	1,203	105,7	2,7
<i>H</i>			38,19	38,19		1,35	1,378	93,92	2,46

**Table 4.** Comparison of the results of safety factors

	Manual analytical calculation		KISSsoft		Difference	
	Critical points		Critical points		G	H
	G	H	G	H		
$\beta_{\tau}$	1,178	1,35	1,171	1,38	0,007	0,03
$K_{\tau}$	1,203	1,378	1,197	1,34	0,006	0,038
$\tau_{\tau WK}$ [N/mm <sup>2</sup> ]	120,6	105,2	121,2	107,5	0,6	2,3
$\tau_{\tau bADK}$ [N/mm <sup>2</sup> ]	105,7	93,92	97,04	96,1	8,66	2,1
$S_D$	<b>2,7</b>	<b>2,46</b>	<b>2,54</b>	<b>2,51</b>	<b>0,16</b>	<b>0,05</b>

The tables above show very small differences between the calculation by KISSsoft and manually calculation. These differences exist because of the fact that the most influence factors values have been adopted and rounded down during calculation. Nevertheless, difference on point *H* exists because of the next elements: factor of surface quality used for calculation in KISSsoft was 1 (value one –that means - no influence on safety factor) and factor of surface quality in manual calculation for all critical points is calculated using forms (19) and (20), from DIN 743-2, [2].

Although differences in calculation of critical stresses are notable, the difference in total safety factor is very small and it is not so important. Designers in process of design and calculation of shafts, during adopting shaft diameter, use bigger safety factor and they usually use results of calculations (from software or from manual approach) as a base for making decisions. In accordance with the previously said, it could be concluded that both methods of calculating safety factor are authoritative.

From the point of faster calculation and overview visualisation, advantage could be on the KISSsoft software side, because of the facts that using software is not required from the designer position and software offers warning in case of bigger mistakes.

Also, a big advantage of KISSsoft software is a complete report with all elements about calculation of capacity. The Report on capacity for chosen shaft which has been obtained in KISSsoft is given in Contribution 2, [4].

## CONCLUSION

This paper presents an example calculation using KISSsoft software. The results obtained by this software are compared with the results obtained by manual calculations. This comparison was helpful for conclusion that both of methods are relevant for the verification of safety factors. This paper gives recommendation that advantage for calculating safety factor has KISSsoft software, because it quickly calculates the safety factor, it is visually suitable, it draws diagrams. All previous characteristics make process of design and calculation of shafts much easier.

The next step in calculating shaft would be in introduction of FEM analysis for checking safety factors. First, it would be necessary to make a shaft model in some of the FEM softwares and then check the results. In theory, the best results would be provided by methods of combining FEM and DIN 743. General conclusion of this paper is a fact that a safety factor is a factor of uncertainty, in fact – a factor of a designer's inexperience. This conclusion is the result of the fact that DIN 743 is based on various empirical forms, which has been obtained by experimental research, for defined shaft and axle types. Behaviour of these mechanical elements in exploitation is the best indicator of calculation accuracy.

## REFERENCES

- [1] DIN 743-1. Tragfähigkeitsberechnung von Wellen und Achsen; T1: Einführung, Grundlage. Beuth, Berlin. Oktober 2000.
- [2] DIN 743-2. Tragfähigkeitsberechnung von Wellen und Achsen; T2: Formzahlen und Kerbwirkungszahlen. Beuth, Berlin. Oktober 2000.
- [3] DIN 743-2. Tragfähigkeitsberechnung von Wellen und Achsen; T3: Werkstoff – Festigkeitswerte. Beuth, Berlin. Oktober 2000.
- [4] Đurić, A.: Proračun vratila i osovina prema standardu DIN 743. Završni rad, Mašinski fakultet Istočno Sarajevo, Istočno Sarajevo 2013.
- [5] Marković, B.: Metodološki pristup upravljanja ljudskim resursima, u procesu razvoja proizvoda. Doktorska disertacija. Mašinski fakultet Niš, Niš, 2008.
- [6] Miersch N.: Konstruktion einer Getriebewelle für Fräswerkzeug. Wildau, Njemačka, 20.06.2010.
- [7] Miltenović, V.: Mašinski elementi – oblici, proračun i primjena. Mašinski fakultet Niš, Niš, 2009.
- [8] Miltenović, V.: Mašinski elementi – tabele i dijagrami. Mašinski fakultet Niš, Niš, 2009.
- [9] Miličić, D., Agatonović, I., Mijajlović M.: Program module for strength check of the shaft and axles according to the DIN 743. Zbirka radova sa konferencije ADEKO, Fakultet tehničkih nauka Novi Sad. Novi Sad, 2009. Str 277.
- [10] Miličić, D., Živković, D., Mijajlović M., Miladinović S.: Proračun nosivosti osovina i vratila prema DIN 743. Zbirka radova sa internacionalne konferencije COMETA, Mašinski fakultet Istočno Sarajevo. Jahorina 28.-30. Novembar 2012. Str 277.
- [11] Ognjanović, M.: Mašinski elementi. Mašinski fakultet Beograd, Beograd, 2006.
- [12] \*\*\* <http://kisssoft.ch>
- [13] \*\*\* <http://www.technicaljournalonline.com>

## **SESSION 3: Manufacturing Technologies and Materials**

## REFLECTOR WITH MULTILAYER STRUCTURE

Petar Shindov<sup>1</sup>, Dimitar Petrov<sup>2</sup>, Atanas Rusev<sup>3</sup>

<sup>1,2</sup>Technical University - Sofia, branch Plovdiv, Plovdiv, Bulgaria

<sup>3</sup>MegaplastBG Ltd, Plovdiv, Bulgaria

e-mail: [p\\_shindov@mail.bg](mailto:p_shindov@mail.bg)<sup>1</sup>, [dimgog@abv.bg](mailto:dimgog@abv.bg)<sup>2</sup>, [office@megaplastkladno.com](mailto:office@megaplastkladno.com)<sup>3</sup>

**Abstract :** In the report are presented the results from the study and the preparation of a multilayer structure, which is included into the structure of a reflector on the basis of polymethylmethacrylate with a reflective layer of aluminium and a protective layer of an alloy of copper-aluminium. The reflector is used in reflective systems, in the design of interior mirrors and traffic mirrors, in solar collectors and others.

**Key words:** protective layer, reflective layer, adhesion, deposition of layers, vacuum, multilayer structure

### INTRODUCTION

Known are reflectors used in the reflective and optical systems, given in Figure 1, which structure includes a glass or transparent plastic on the which surface are deposited the reflective layer of silver or aluminium [1]. The reflective coating is protected by means of a layer of metal oxide, most often aluminium oxide or silicon oxide. This layer requires performing additional processing operations. The preliminary forming of the bearing base of the reflective layer as part of a sphere or a parabolic hinders the application of reflective or protective layers with uniform thickness on the all surface. For uniform thickness of deposited layers on the surface in the magnetron systems it is necessary rotation of the work pieces that are to be covered and the big sizes of work pieces bring technical problems, too. Applying a protective layer by means of polymerization in vacuum HMDSO [2] results in deposition of material onto the sputtering systems and the walls of the chambers, which have to be cleaned in a given period. The use of painting equipment for applying protective coating makes more expensive the products and it is accompanied by the appearance of intermediate layers of unwanted inclusions, aerosols, dust and more.

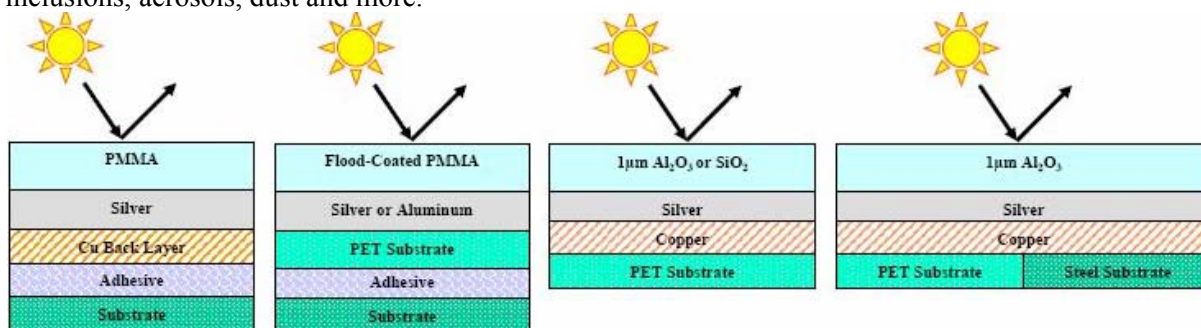


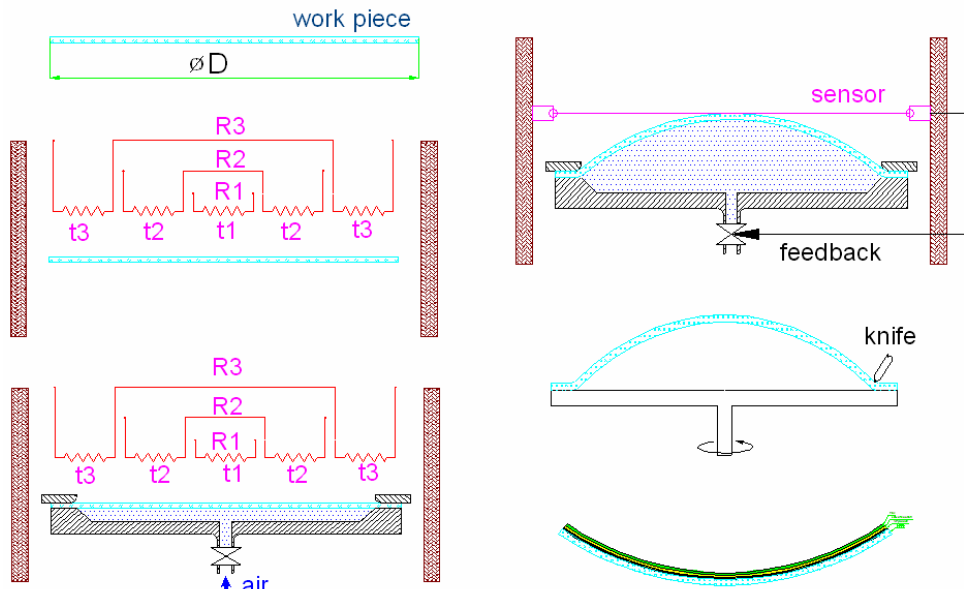
Figure 1. Constructions of multilayer reflectors

In our previous work [3] we have shown that the method of vacuum thermal evaporation is suitable for deposition of layers of aluminium on large parts for reflectors. The aim of this work was to create a reflector with a multilayer structure, as in a single technological cycle to be deposited successively reflective layer of aluminium and a protective layer of an alloy of copper-aluminium.

The deposition of the layers in a vacuum is conducted with the vacuum system BH 90. The adhesion of the layers is determined according to the methodology of the standard ASTM D3359-97 by means of degrees from 0A to 5A with the use of adhesive tape 3M Scotch 810. The surface morphology was studied using an optical microscope JENA VERT and scanning electron microscopes BS 340 and QUANTA 3D 200i. The conductivity of the protective layers was measured on specimens in the shape of a meander.

## EXPERIMENTAL SECTION

Preparations of polymethylmethacrylate are formed according to Figure 2. The method is different in comparison of the method of pneumatic and vacuum forming. The creation of appropriate thermal gradient through the system by the heater matrix and the dosing of the air flow are the basic parameters in the technological sequence of forming of the sheet material. Onto the pre-formed inner surface, after removing the protective foil, reflective layer of aluminium and a layer of aluminium or copper alloy successively are coated by vacuum thermal evaporation.



**Figure 2.** Technological sequence of forming the sheet material

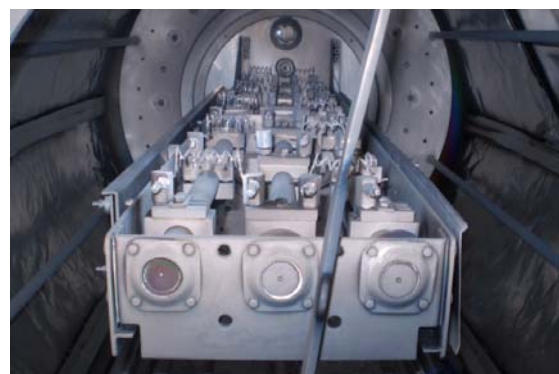
The used system BH 90, shown in Figure 3 and Figure 4, is equipped with two systems of linear evaporators. Technical parameters of the installation enabling conducting processes at: an electric current for evaporation of up to 1200 A; power of the glow discharge to 5 kVA; number of water-cooled evaporators - 12; distance evaporator-substrate up to 1200 mm.

The layers are deposited in a single technological cycle without disturbing the vacuum in the processing chamber using the method of vacuum thermal evaporation. The two metals (aluminium and copper) have similar values of temperatures of evaporation and relatively different - of melting. The proportion of copper to aluminium for the different experiments is changed in the research process.

The used equipment for deposition provides a smooth transition from the aluminium layer, serving as a reflector to the protective layer of aluminium-copper alloy, which is characterized by a high corrosion resistance [4].

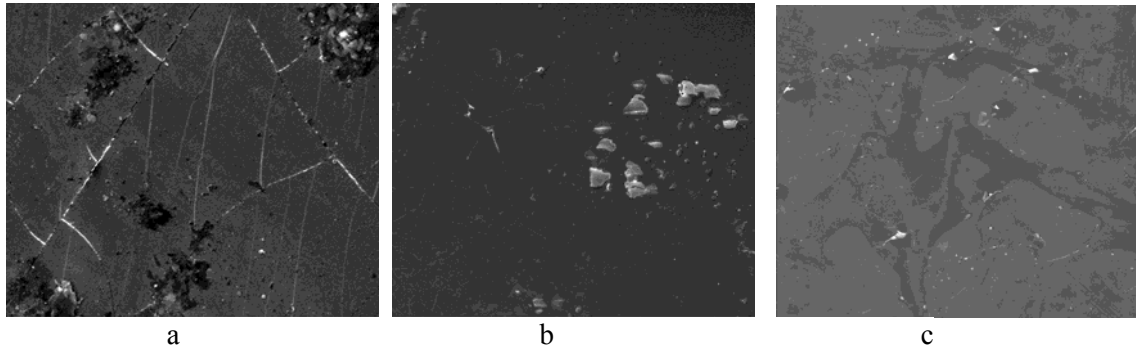


**Figure 3.** System BH 90.



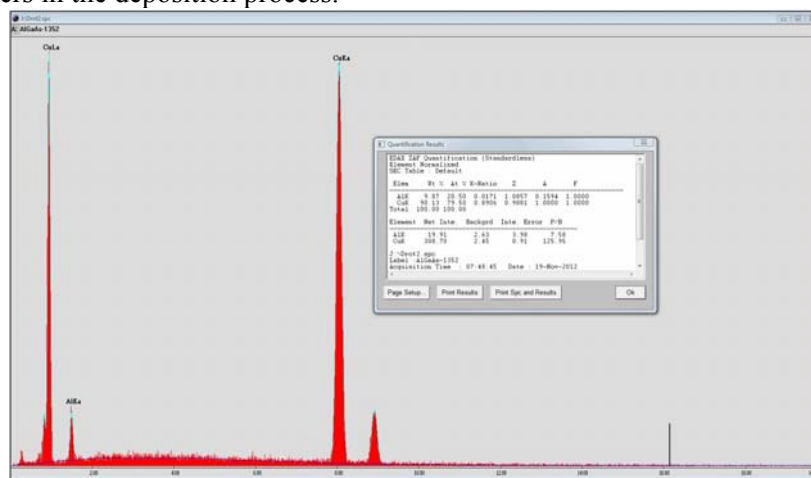
**Figure 4.** System for the deposition of layers with linear evaporators.

On figure 5a, 5b and 5c are shown photographs of the morphology of the surface after deposition of the protective coating at different ratios of the components of the protective coating Cu/Al- 70/30, 80/20, 90/10. Dense and uniform layer at selected technological sequence is achieved for protective coating at ratio of its components Cu/Al = 90/10. For the indicated ratios of the components of the protective coatings, the measured values of the adhesion are respectively 2A, 4A and 5A.

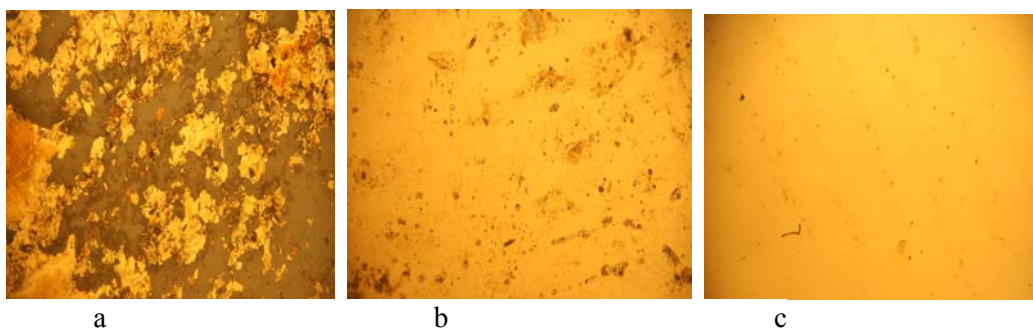


**Figure 5.** Surface morphology at magnification 5000x: a. 70/30; b. 80/20; c. 90/10.

On the figure 6 the results from electron microprobe analysis are shown at the ratio of copper to aluminium 9:1. The results of the tests for corrosion resistance (NaCl, HCl) are given in Figure 7a, 7b and 7c – the values are highest at the ratio 90/10. The deposited layers are characterized by a linear changing of the sheet conductivity with respect of the coating thickness as it is shown in figure 8. The sheet conductivity of the protective layer decreases with the increasing of the aluminium component. At thicknesses exceeding 200 nm are established divergences in the values of sheet conductivity for the different ratios of components of the protective layers. The data can be used to measure the thickness of layers in the deposition process.



**Figure 6.** Electron microprobe analysis of layer 90/10



**Figure 7.** Treated surfaces for corrosion resistance - a. 70/30; b. 80/20; c. 90/10;

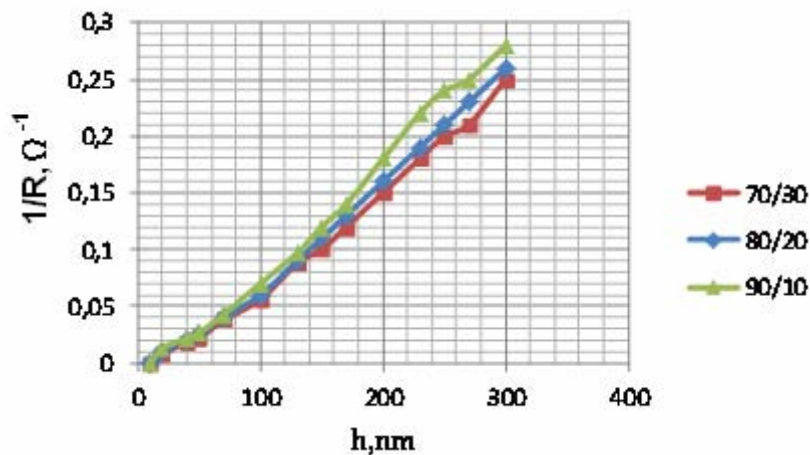


Figure 8. Sheet conductivity of the protective coating with respect to its thickness.

## CONCLUSION

The results of the experiments conducted for the production of a reflectors with a multilayer structure showed, that with the selected technological sequence and composition (of layers) is achieved a high degree of adhesion, dense and uniform layer with high corrosion resistance at the ratio 90/10 of copper to aluminium. The results of this report are subject to protected utility model of "MegaplastBG" [5].

## REFERENCES

- [1] C.Kennedy, K.Terwilliger, C.Lundquist, CSP FY 2005 Milestone Report, "Provide status of test results of candidate solar mirror samples and identify promising candidates", September, (2005).
- [2] G.Lopardo, R.Mossotti, R.Innocenti, G.Mazzuchetti, Polimerizzazione in plasma di HMDSO su tessuti a maglia di lana ad azione anti-pilling, Proceedings of the 6<sup>th</sup> Health and Textile International Meeting, Biella, Italy (2006).
- [3] П.Шиндов, Д.Петров, А.Русев, В.Вълчев, DC плазмена модификация на полимерната повърхност при формиране на прехода метал-полимер, Научни трудове на Съюза на учените в България, Серия В, Техника и технологии, 10-11.12, (2011).
- [4] Z.E.Horváth, G.Peto, Z.Pásztai, É.Zsoldos, E.Szilágyi, G.Battistig, T.Lohner, G.L.Molnár, J.Gyulai, Enhancement of oxidation resistance in Cu and Cu(Al) thin layers, Research Institute for Technical Physics and Materials Science (MFA) of the Hungarian Academy of Sciences, Budapest, P.O.B. 49,11-1525 Budapest, Hungary,(2011).
- [5] А.Русев, П.Шиндов, Свидетелство за регистрация на полезен модел №1609, BG 1609 U1, "Рефлектор с многослойна структура" (2012).

## THE ANALYSIS OF THE RESULTS OF DEVELOPMENT AND PRODUCTION OF COATED ELECTRODES WITH A CORE OF FLUX-CORED WIRES

Nikola Bajić<sup>1</sup>, Mihajlo Mrdak<sup>5</sup>, Slobodan Stojadinović<sup>3</sup>, Jasmina Pekez<sup>3</sup>, Karastojković Zoran<sup>4</sup>, Marko Rakin<sup>2</sup>, Darko Veljić<sup>1</sup>

<sup>1</sup> Techno experts d.o.o – Research and Development Center, Belgrade, Serbia

<sup>2</sup> Research and Development Center, IMTEL komunikacije a.d Belgrade, Serbia

<sup>3</sup> Technical Faculty „Mihajlo Pupin“ Zrenjanin, Serbia

<sup>4</sup> Advanced Technical School for Vocational Studies, Belgrade, Serbia

<sup>5</sup> Faculty of Technology and Metallurgy, University of Belgrade, Karnegijeva 4, Belgrade, Serbia

e-mail: [ihis@eunet.rs](mailto:ihis@eunet.rs)

**Abstract:** The objective of this paper is the analysis of the results of development and production of new coated electrodes with a core of flux-cored wires. The main objective of replacing the core of solid wire with flux cored wire is to improve the welding productivity and flexibility of changing the composition of the core, thereby obtaining a weld metal of designed chemical composition and mechanical properties. The technological process consists of the phase of production of cored wire designed for producing the core of the coated electrode and the second phase of applying coatings on the press for continuous coating.

**Key words:** covered electrodes, cored wire, manual metal arc welding process

### INTRODUCTION

This is explained by the simplicity of the welding process, the good and easy operation, streamlined composition of weld metal.

The process of alloying of the weld metal during welding with coated electrode may be from the core and the coating of the electrode. According to literature [1-3] the best way to alloy weld metal in terms of chemical composition uniformity is from the electrode core with alloying elements coming from solid metal core. Replacing of solid metal core with flux-cored wire provides broader technological capabilities in terms of the flexibility of introducing alloying elements in the weld metal alloying, oxidation loss of alloying elements, increase in welding speed. To create a cored wire core materials used are similar in composition to materials for coating the electrode.

Replacing flux cored wire instead of solid wire for making the core of coated electrodes provides real opportunities that with its chemical composition the cored wire combined with appropriate coating give the desired composition of the weld metal. Proper selection of adequate quality cored wires for core production and optimal composition of the coating of the new electrode can significantly improve the quality of welded joints and increase productivity. Production of the new electrode with a core made of flux-cored wire requires special technical solutions for individual technological operations in particular in cutting ends and closing to prevent powder spilling [1-3].

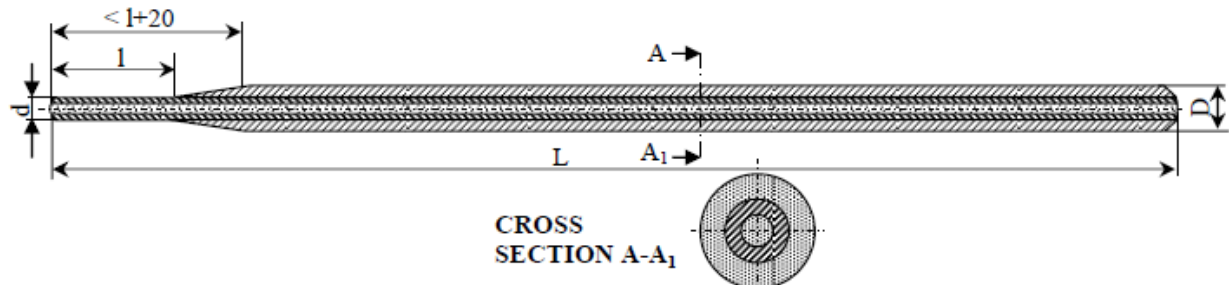
### EXPERIMENTAL

The experimental part includes the production of coated electrodes with a core of solid and flux-cored wires for the purpose of comparison of test results. To create a solid wire core wires of 2.0 and 3.25 mm in diameter is selected with a chemical composition: 0.10% C, 0.03% Si, 0.6% Mn. For making an electrode core of flux-cored wire, on the line for calibration and filling in IHIS RDC Belgrade, produced was a certain quality cored wire, from a steel strip 0.8 mm thick and 10 mm wide, chemical composition: 0.10% C, 0.03% Si, 0.45% Mn, from domestic production. Plastic processing of the flux-cored wire was continued on the wire drawing machine reducing the diameter of 4.0 mm to a final diameter of: 2.0 and 3.25 mm. Coils of solid and flux-cored wire with final diameters 2.0 and 3.25 mm were, using a straightening and cutting machine, cut into rods 350 mm in length intended for the production of the core of the coated electrodes.



Mastering and pilot production of coated electrodes was carried out on an experimental line for coating in the IHIS Research and Development Center in Belgrade.

Layout of longitudinal cross section of a new special coated electrode with a core of flux-cored wire is shown in the diagram, Figure 1. Before the coating process of flux-cored wire the ends need to be closed by a coating of graphite powder and binder.



**Figure 1.** Sketch of the longitudinal cross section of the coated electrode with a core of flux-cored wire

## RESULTS AND DISCUSSION

Tested was the compactness and eccentricity of the coating, then the metallographic and mechanical properties of welded joint as well as testing the welding-technological properties of coated electrodes with cores of solid and flux-cored wire.

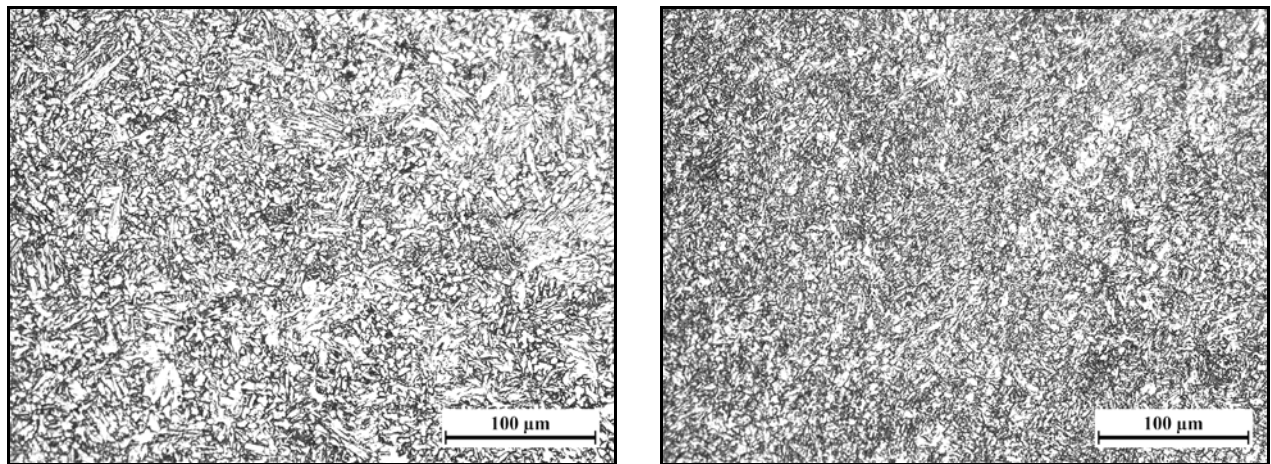
Examination of compactness of coating is performed by dropping the electrode in free fall on a smooth steel plate from a height of 1 m. The results obtained by testing compactness using the selected method are very satisfactory since there was no crumbling or falling off of coating. A particular problem in the coating of flux-cored wire is the appearance of coating eccentricity which is necessary to be brought to the allowed level. Eccentricity of the coating ( $e$ ) has been tested using a method based on measuring the thickness of electrode coating in three places lengthwise at a distance of 50-100 mm and the circumference of at an angle of  $120^\circ$ . Eccentricity values were calculated using the formula:  $e = S - S_1$  and the measurement results are given in Table 1. According to literature allowed coating eccentricity is up to 1 mm.

**Table 1.** The measured values of thickness of coating and the calculated eccentricity ( $e$ )

Measuring point	S (mm)	S <sub>1</sub> (mm)	Eccentricity $e = S - S_1$ (mm)
1	4,00	3,8	0,20
2	4,05	3,8	0,25
3	3,90	3,9	0,00

Experimental welding was done by manual electric arc process using a coated electrode with a core of solid and flux-cored wire, and then testing of the characteristics of welded joints was performed. Visual inspection showed that: the electric arc is easily established and burns steadily; coating melts evenly; there was not much splatter, observed was uniform spreading of electrode material in all welding positions; notes even spreading of slag and only separation after cooling especially in surfacing in the horizontal position.

The structure of the weld metal is fine-grain pearlite-ferrite, Figure 2.a. In the surface passing to the face of the weld metal the structure is extremely coarse dendritic ferrite-pearlite with a share of bainite. HAZ structure is uniform ferrite-pearlite, Figure 2b.



**Figure 2.** Microstructure of the weld metal (a) and HAZ of the welded joint (b) made with a coated electrode with a flux-cored wire core

## CONCLUSIONS

Production of cored wire designed for welding the MIG / MAG process, submerged arc process in several metallurgical qualities is a basis for further upgrades to a new product in the form of a coated electrode with a core of flux-cored wire designed for welding and surfacing low-carbon, alloyed and high alloyed steels.

Based on the results of comparative analysis of welding properties of coated electrodes with a core of flux-cored wire with respect to electrodes with a classic solid wire core certain advantages were observed in terms of:

- easier management of the welding process;
- quality formation and separation of slag from the weld metal;
- stable arc management.

Moreover, it is expected that with the alloyed electrodes with a flux-cored wire to achieve uniform chemical composition along the length of the weld metal and lower oxidation loss of alloying elements compared to the classic coated electrode where the alloying elements are within the coating.

## Acknowledgements

This work is supported by the Serbian Ministry of Education, Science and Technological Development (project number TR34016 "Development of covering and core production technology based on local raw materials for manufacturing of special coated electrodes designed for steel arc welding" & TR 35002" Development of new methodologies for revitalizing turbine and hydro mechanical equipment of hydroelectric power stations depending on the cause of degradation of the material").

## REFERENCES

- [1] N. Bajić, S. Stojadinović, J. Pekez, M. Mrdak, Z. Karastojkovic, Z. Radosavljevic., II International Conference Industrial Engineering and Environmental Protection , ISBN 978-86-7672-184-9., Zrenjanin, (2012) p.93-99.
- [2] N.N. Potapov, D. N. Baranov, O. S. Kakovkin, D. B. Vitman i dr.: „Svaročne provoloki i elektrodi“, ISBN 5-217-01236-8., Moskva, Mašinostrenie, (1993).
- [3] N. Bajić, V.Šijački-Žeravčić, B.Bobic, D.Cikara, M. Arsić., "Filler Metal Influence on Weld Metal Structure of Micro-Alloyed Steel", Welding Journal, Supplement Vol.90, ISSN 0043-2296 (2011) p.55-62.

## PROPERTIES OF A SLIDING BEARING MADE OF MULTI-LAYER MATERIALS PRODUCED USING EXPLOSION ENERGY

Rade Katana<sup>1</sup>, Nikola Bajić<sup>2</sup>, Slobodan Stojadinović<sup>3</sup>, Jasmina Pekez<sup>3</sup>

<sup>1</sup>Trimetal, 11147 Beograd, Serbia,

<sup>2</sup>Techno experts d.o.o. – Research and Development Center, Belgrade, Serbia

<sup>3</sup>Technical Faculty „Mihajlo Pupin“, Zrenjanin, Serbia

e-mail:katana.rade@gmail.com

**Abstract:** Presented in this paper are the characteristics of the bond of the sliding alloy with the steel base of the sliding bearing made using explosion energy for constructions intended for various purposes and bimetal qualities. This paper analyzes three groups of bonded sliding alloys with a steel base made using explosive welding energy. The group first analyzed is the turbine bearings that have an intermediate layer of copper applied using explosion energy. The second group is an explosion welding formed sliding layer of bronze on the inner side of the cylinder of the hydraulic press. In the third group of sliding bearing joints, special attention in the review was given to the formation of bimetal steel + AlSn20Cu1, which is designed for heavy-duty diesel engines in locomotives, ships, oil pumping facilities, mill housings, crushers, etc..

**Key words:** antifriction alloy, explosion welding, emulsion explosive, hydraulic cylinder, plane bearing liner, welded joint, thermal treatment

### INTRODUCTION

Sliding bearings are one of the most responsible and most accurate elements of the structures into which they are fitted. They have a very sensitive and responsible role and the life span of the structure and therefore the whole plant depends highly on their capacity and quality.

A number of factors affect the durability of the bearings in working mode: the choice of bearing materials, as a cooperative part, lubricant quality, cleanliness and impact of the lubrication system, precision during bearing installation.

Bearings consist of a steel bearing shell with a high modulus of elasticity which provides a firm bearing set, and one or more layers of bearing materials. A good bearing material must have a certain plasticity and differential hardness of the basic components. The hard components are able to sustain impacts without deformation, and the soft base has a role to absorb those impacts and adapt to the journal.

The hard base consists of Al, Al+Cu and the soft structural parts of: Sn, Pb, and other. These structures accumulate 90 to 98% of the friction energy. High wear resistance and durability against scuffing, is caused by the squeezing out the soft secondary parts of the base, which form a thin protective film of soft metal, which now acts as a solid lubricating material i.e. solid lubricant.

A good bearing material has sufficient hardness, the ability to accommodate high loads, the ability of surface adjusting, the capacity to bind the oil film to itself, a low expansion coefficient, good thermal conductivity, corrosion resistance in the lubricant, low sensitivity to marginal deformations etc. [1-4].

Destruction of the working antifriction metal occurs under variable load conditions. Residual stresses caused by the different coefficients of linear expansion of the steel base of the bearing and the antifriction layer, lead to a sudden drop in load capacity threshold of the sliding layer. The clearance gap for lubricants, which draws heat and separates the wear surfaces is extremely important. Increasing the gap lowers the temperature of the wear surface, thus increasing the bearing fatigue strength. However, a very large gap causes an increase of dynamic impact loads, which may adversely affect the fatigue strength, which in steel is lower than the elastic limit [5-6].

Bearing material is applied to the supporting steel base using various technological processes: pouring, expanding, sintering, conventional surfacing, and most recently explosion welding. When bonding Al-Sn alloys with steel, every technological process that melts the alloy is inapplicable, because it causes the tin in the alloy to be deposited, and if rapid cooling is not achieved the sliding alloy loses its characteristics. Achieving a completely homogeneous bond of these alloys with the bearing steel base, using explosion energy, is the only reliable technological procedure today [5-6].

## EXPERIMENTAL

- **Turbine bearing with an explosion applied copper interlayer**

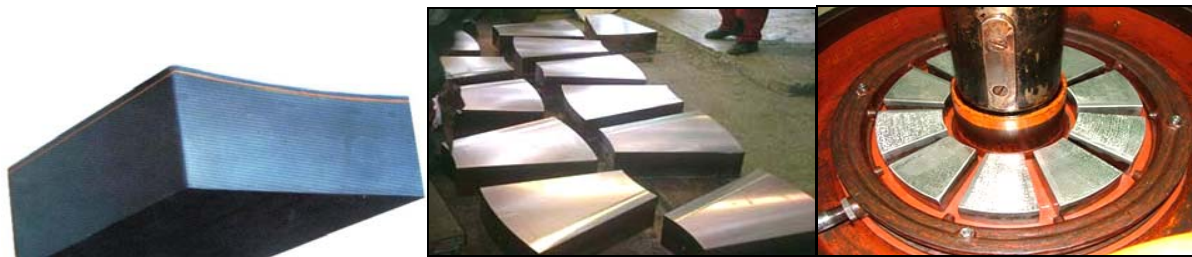
This type of bearing sliding layer should possess the following mechanical and technological characteristics: density ( $\rho = 738\text{kg/m}^3$ ), melting temperature ( $370^\circ\text{C}$ ), linear shrinkage (0.65%), tensile strength ( $R_m = 90\text{MPa}$ ), compressive strength ( $R_m$  pressure =  $115\text{MPa}$ ), hardness at  $20^\circ\text{C}$  ( $\text{HB} = 30$ ), friction coefficient in contact with the shaft ( $\mu = 0.005$ ).

Chemical composition: (10-12)% Sb; (5.5-6.5)% Cu, the remainder Sn + impurities (mass%). The required chemical composition is very close to the composition of the alloy B 83.

In forming a quality bond two elements are important: that there are no unbonded spots on the bond surface and that bond strength is high enough to prevent splitting of already joined surfaces. At the unbonded spots stress concentration occurs. Stress in these spots is higher than nominal and there starts the separation of the bearing from the base, regardless of whether the bonded spots possess strength that would be enough if there was no affect of stress concentration factors.

The emergence of unbonded parts between the base and the babbitt metal is usually related to mechanical impurities, oxidized areas, parts contaminated with oils and moisture, as well as inclusions on the surface. Adhesion of the coating layer depends on the capillary forces and the angle at which a small part of the liquid metal is in interaction with the solid surface. Therefore, the preparation of the base surface is a very important element for the process of pouring of the babbitt metal [1, 5-6].

In recent years, using explosion welding a pre-coating with a layer of copper on the bearing steel base is done for better bonding of babbitt metal during pouring (Fig. 1).



**Fig.1.** Turbine bearing with the explosion applied copper interlayer

- **Explosion application of sliding layer (CuSn8) into the hydraulic press cylinder**

In practice, two methods are used to achieve a steel TS5 (Č.1213) cylinder and sliding alloy CuSn8 bond. Compared with conventional methods of welding the sliding alloy to steel, the brass + steel bond using explosion welding is more homogeneous, with significantly higher bond strength. The bond has uniform strength and is in the range of  $367\text{-}394\text{ N/mm}^2$ . The joint boundary is wavy with no visible intermetallics in it.

However, in the conventional surfacing processes, with electrodes, there is an evident parallel formed micro-constituent of significantly increased hardness (450 HV), which significantly weakens the joint and reduces service life. Bond strength varies and can range from  $113\text{-}257\text{ N/mm}^2$ . The quality of these joints largely depends on the level of training of welders [5-6].

In Figures 2 and 3 shown is the technological process of welding a sliding layer on the inside of the cylinder and the result of the mechanical-metallographic test of the boundaries of the joint made.

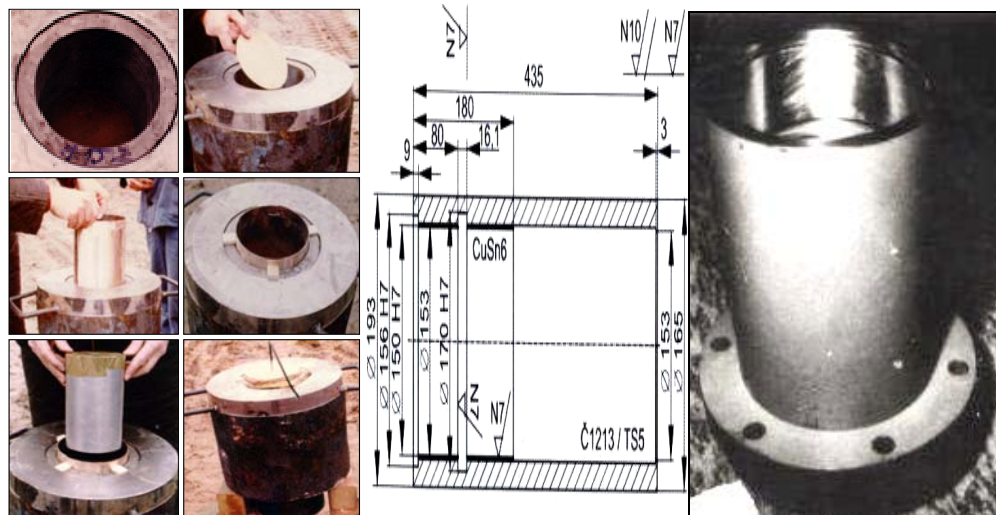
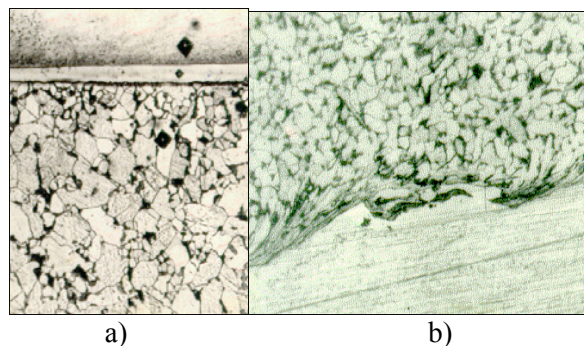


Figure 2. The technological process of bronze plating of a hydraulic press steel cylinder



Joint boundary	Micro hardness, HV <sub>0.01</sub>	
	Joint welded with an electrode	Explosion made joint
Bronze	121	227
Joint boundary	464	322
Steel	138	157

Figure 3. The steel - bronze joint boundary achieved by surfacing using an electrode (a), the boundary of the bond made using explosion welding (b) with simultaneous showing of hardness values of joint boundaries for both welding processes(c).

- **Bimetal sliding bearing (steel + AlSn20Cu1)**

Aluminum alloys have a number of characteristics that distinguish them as a promising material in the production of sliding bearings: they have high thermal conductivity, lubricating characteristics and the ability of binding with the oil layer and a much wider range of load and speed. Alloys have a low modulus of elasticity which provides maintaining of normal operating conditions of the bearing in machine designs with a shaft deflection [1].

Sliding alloy (AlSn20Cu1) has the ability of surface adjusting, the capacity to bind the oil film to itself, a small expansion coefficient, good thermal conductivity, corrosion resistance to the lubricant, low sensitivity to marginal deformations. Bearing is stable against scuffing.

Stress-strain state analysis of bimetal steel-AlSn20 Cu1-points to a 3 layer model with a inhomogeneous bonding zone with a thickness of 0.3-0.5 mm. Soft elements in the bond represent an interlayer between the hard parts and deformations are concentrated in them. Soft elements are basically on the surface of aluminum, the hard elements are on the base of steel and the very hard are intermetalloid inclusions.

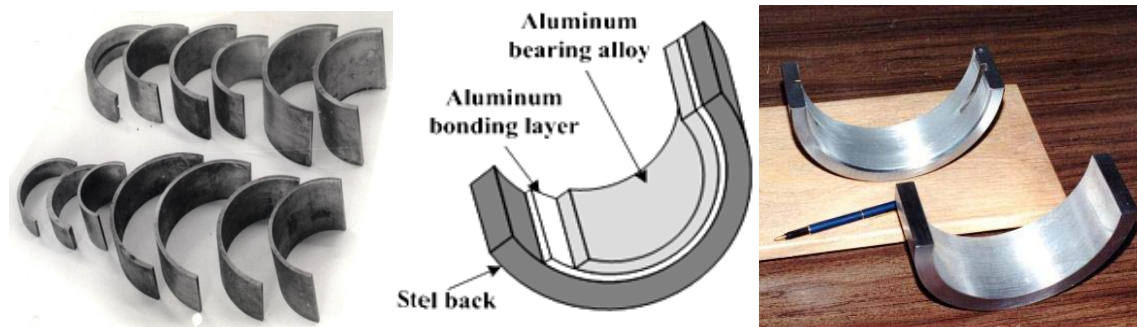
This bimetal is also produced by expanding to 5 mm thickness. Above this thickness production is uneconomical because it requires powerful and expensive rolling mill stands. It is interesting to compare the quality of explosion welded bimetal with bimetal made by rolling steel and alloy AlSn20. Static testing of bimetal show that R<sub>m</sub> (tensile strength), when tested to rupture, is about 30-35% higher than in the shearing test. Bi-metal made with explosion welding has about 20% higher strength properties than bimetal produced by rolling.

A technical aluminum layer 0.15mm thick is rolled on to the anti-friction AlSn20 Cu1 layer and then applied to the steel base of the bearing. Actually the bonding of the sliding alloy and steel is achieved

through technical aluminum so the bonding strength is determined by the quality of the aluminum and steel bond.

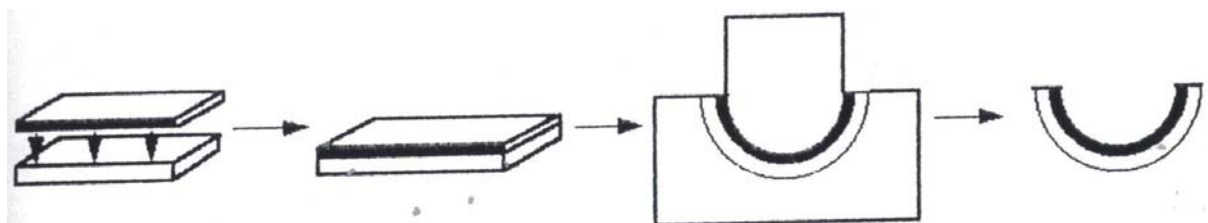
The fact that tin and aluminum do not form a chemical compound, and that an independent phase of easy melting inclusions appears in the alloy, leads to the phenomenon that during alloy deformation tin is extruded to the surface and the quality of the bond is decreased. Limiting the amount of tin is possible by reducing the zone affected by plastic deformation [5-6].

This observed problem directed further research to the mastering of emulsion explosives with which to achieve lower speeds and angles of collision of metals in the joint. Compared to previously used ammonium nitrate explosives, for a successful combination a 2 times smaller quantity of explosives is enough, which significantly reduces the level of plastic deformation and the amount of heat released. This way we achieve a high quality homogenous direct bond of steel and alloy AlSn20. Within the limits of 42-60 MPa, this with additional heat treatment at 350°C is increased to 60-80 MPa.



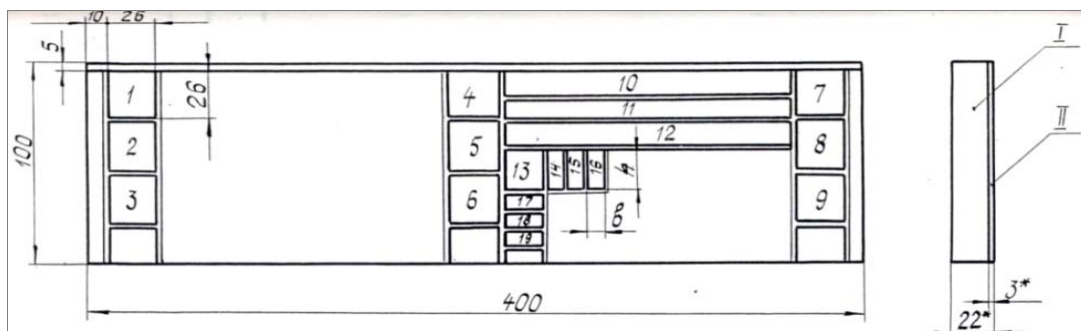
**Figure 4.** Bimetal bearing (Č1120 + AlSn20) for a locomotive series 661 diesel motor

Technological process of making a steel + AlSn20Cu1 sliding bearing intended for heavy loads is shown in the diagram, Figure 5



**Figure 5.** Technological process of making a sliding bearing (explosion bonding of metal, machining edges of bimetal, drawing-bending and finishing of the bearing)

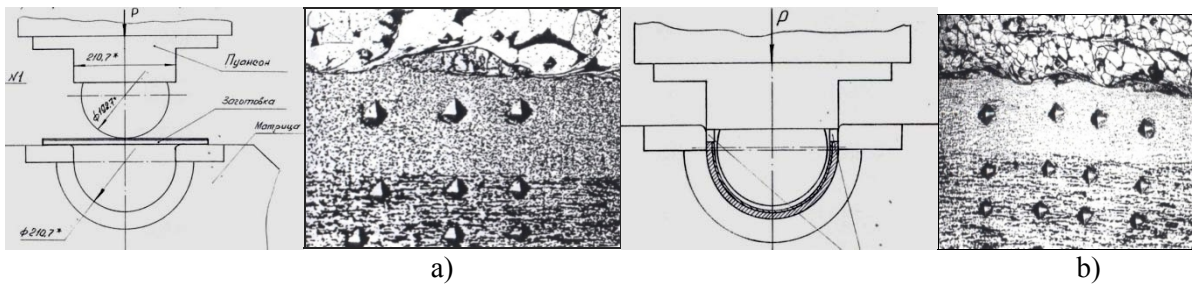
The sampling plan for mechanical and metallographic testing is shown in the schematic, Figure 6. The results of shear strength testing are clearly shown in Table 1 and the results of the micro hardness testing are shown in Table 2.



**Figure 6.** Locations of sampling for further mechanical and metallographic testing

**Table 1.** Results of shear strength testing of bimetal samples

Shear strength values of bimetal samples						
Samples	Direction of shearing force	b mm	h mm	S mm <sup>2</sup>	F kg	P kg/mm <sup>2</sup>
13	Vertical to joint direction	4.75	10.2	48.45	418	8.6
14		4.8	10.0	48.0	426	8.8
15		4.8	10.15	48.7	372	7.6
17	Parallel to joint direction	4.3	9.65	41.5	398	9.6
18		4.3	9.65	41.5	346	8.3
19		4.3	9.7	41.7	384	9.2



**Fig. 8.** Micro hardness in the explosion zone of derived bond (a), after bimetal drawing to a bearing pre-form (b)

**Table 2.** Results of micro hardness (HRB) testing on steel + AlSn20Cu1 bimetal after explosion welding and after forming of the bearing jacket

Micro hardness measuring results (HRB)							
Material	Steel				Al 99.5	AlSn20	
	Center	from joint		Steel surface		from joint	
		0.03 mm	0.14 mm			0.05 mm	0.15 mm
Steel	130	-	-	-	-	-	-
Bimetal Steel+AlSn20 /After explosion welding/	150	223	207	-	50	57	57
Bimetal Steel+AlSn20 /after bimetal drawing/	180	223	197	199	49	55	53

## CONCLUSION

1. Application of explosion energy is a reliable procedure for the realization of high quality and homogeneous bonds between the sliding alloy and the steel base of the sliding bearings.
2. The paper presents manufacturing experience in demanding operating systems with alloys in which the individual components do not form chemical compounds, so it is more difficult to bond those using conventional welding methods.
3. Special emphasis is given to mastering of a bearing with the sliding alloy AlSn20 with and without an intermediate layer of technical aluminum.

## Acknowledgements

This work is supported by the Serbian Ministry of Science and Technological Development (project number TR34016")

## REFERENCES

- [1] А.А.Дерибас, Физика упрочнения и сварки взрывом. Новосибирск. Наука, 1980.
- [2] И.Д.Захаренко. Сварка металлов взрывом. Наука і техніка, 1990, с.205с.
- [3] Ю.А.Конон,Л.Б.Первухин,АД.Чудновский. Сварка взрывомю, Машностроение, 1987, с.216.
- [4] Буше Н. А. и др. Подшипники из алюминиевых сплавов. – М.: Транспорт, 1974.
- [5] Злобин Б. С. Разработка научных основ процесса изготовления биметаллических заготовок подшипни-ков с использованием взрыва. – Дисс. док. тех. наук, Новосибирск, 2000, с.275.
- [6] B. S. Zlobin, V. V. Sil'vestrov, A. A. Shtertser, A. V. Plastinin: "Peculiarities of bond formation at explosive welding of AlSn20Cu1 alloy with steel"



## INVESTIGATION OF THE INFLUENCE OF THE LEVEL OF CARBON AND NITROGEN POTENTIAL AT HIGH TEMPERATURE CARBONITRIDING OF Mn-Cr STEEL

Željko Rosandić<sup>1</sup>, Dejan Anđelković<sup>2</sup>, Ivan Opačak<sup>1</sup>, Vlatko Marušić<sup>1</sup>

<sup>1</sup> Mechanical Engineering Faculty in Slavonski Brod, Croatia

<sup>2</sup> Faculty of Technical Sciences in Kosovska Mitrovica, Serbia

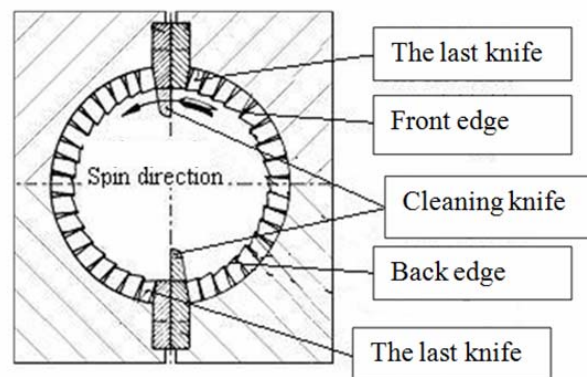
e-mail: [zeljko.rosandic@sfsb.hr](mailto:zeljko.rosandic@sfsb.hr)

**Abstract:** High temperature carbonitriding is a process of heat treatment that is used to increase the surface hardness of components, in order to reduce wear. The worm press for production of vegetable oil was chosen as an example of a system in which the high temperature carbonitrided components, made of Mn-Cr steel, are also built in. In exploitation, the extraction cage knife is exposed to a significant influence of the abrasive media, and the fatigue of material. A decrease of installed capacity efficiency is the result of local damages of components due to wear. The determined dimensional criterion of seizure makes the process of high temperature carbonitriding very suitable for the production of components that are used in the given exploitation conditions. The possibility of changing the level of carbon and nitrogen potential, as well as the effect on the possible life of extraction cage knives, were analysed. The use of a different carbon and nitrogen potential at the high temperature carbonitriding of test samples results in an extremely favourable flow of hardness at the cross-section. It can be observed that the achieved course of hardness is an extremely important indicator that had a significant impact on the final decision on the suitability of the observed process of thermochemical treatment for the intended purpose.

**Key words:** carbonitrided components, high temperature, worm press

### INTRODUCTION

In the worm presses for production of vegetable oil, the extraction cage consists of built-in knives (Fig. 1).



**Figure 1.** Cross-section of extraction cage knives of worm press

Due to the presence of abrasive media and the appearance of fatigue of material that the extraction cage knives are exposed during exploitation, they were usually made by the cladding procedure. The costs of production by cladding, and extremely strict dimensional criterion of seizure and the problems during exploitation (Fig. 2), emphasize the need to examine the use of other methods of production and prolonging life.

Taking into consideration the previous experiences, it can be assumed that the high temperature carbonitriding could give the optimum results, both from the production, but also from the standpoint of behavior in exploitation. The high temperature carbonitriding is a thermochemical surface treatment. The simultaneous diffusion of carbon and nitrogen in the surface forms different depths of martensite, according to the applied temperature. Even though this is an industrial process, which is used to harden the surface of components in order to reduce the wear, the wear mechanism was not

intensively studied. Furthermore, there is little information on the wear of materials and their properties, which vary from the surface to the core. First of all, it is necessary to determine the suitability of high temperature carbonitriding process for application on the steels for cementation that would have not only an affordable price, but also the required properties. If the satisfactory properties of layer are determined, the subsequent testing and the analysis of wear intensity will be performed.



Figure 2. Damaged extraction cage knife – made by cladding

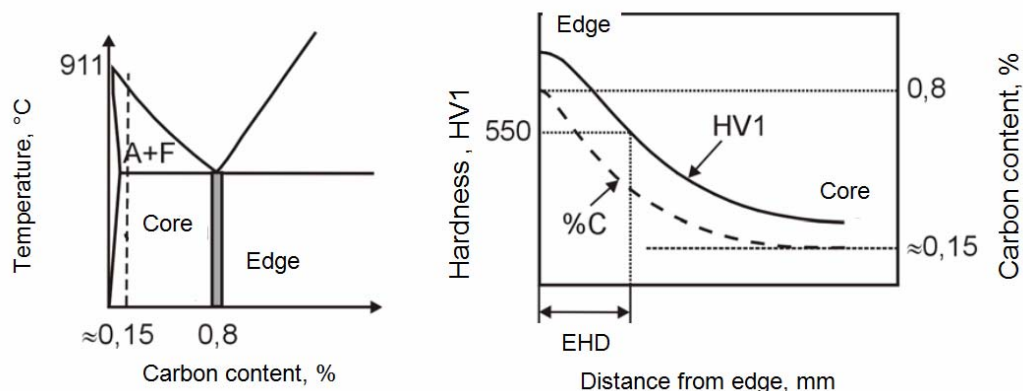
## MATERIAL AND METHODS

### Steels for cementation

Steels for cementation belong to the group of structural steels. They usually contain from 0,1 up to 0,2 %C before carburisation, and can be non-alloyed or low-alloyed. Steels with that low carbon content during hardening cannot achieve sufficiently high hardness, which is necessary to achieve resistance to abrasive wear. Therefore, steels for cementation, after the chip forming treatment with the addition for grinding of surfaces, which should be grinded after the cementation (gear teeth, fits for bearing, crosshead guides, etc.), are subjected to carburisation. Carburisation in granulate, salt bath or gas results in the increased amount of carbon from 0,8 up to 0,9 %C in the surface layer of material. Thus enriched surface edge of material becomes hardenable, i.e. by quenching from a suitable temperature of austenitization, it takes the structure of high-carbon martensite, resistant to wear [1]. The hardnesses after quenching can reach between 60 and 65 HRC. The process of cementation consists of the carburisation and hardening of carburised part, as well as the low-temperature tempering. After cementation, the core of material stays ferritic-pearlitic if the product is not hardened, i.e. it becomes low-carbon martensitic if the core is hardened. Both these structures of core have a high toughness, i.e. after the process of cementation, steel will have a hard surface with good wear resistance, and with relatively tough core.

With alloyed steels, hardening is preferred, because the cemented steels are low-tempered at the temperatures below 220 °C, and greater toughness of the core can be achieved only by the low-carbon martensite. The aim of alloying is to improve hardenability of steel at quenching of carburised object. Due to better hardening of the core, we get the structure of low-carbon martensite, which provides high strength properties of core, its increased fatigue strength and high toughness (diagrams in Fig. 3). Alloying elements have an impact on the process of carburisation of edge of object, i.e. on the speed of the process of carburisation, carbon content in the edge of carburisation of object, depth of carburised boundary layer. Non-carbide-forming elements, like nickel, silicon and cobalt, accelerate the diffusion of carbon in austenite, but also lower the solubility of carbon in the boundary layer, while carbide-forming elements, like chromium, molybdenum, vanadium and manganese, lower the diffusion coefficient of carbon in austenite, and thus increase the carbon content in the boundary layer [1], [2], [3].

One of the main problems when choosing the parameters for the process of carburisation and hardening is how to determine the correct temperature of quenching. Considering the fact that at the same time, there are areas with a high carbon content (the edge with over 0,8%) and low carbon content (core with less than 0,2%), it is necessary to choose a compromise temperature of quenching. The temperature of quenching should be lower than the ideal one for the core (the temperature at which the boundary layer overheats causing a coarse-grained martensite and increased fragility) and higher than the ideal for the high-carbon edge (at which there is incomplete hardening of the core). In this respect, the least problems occur with non-alloyed steels, in which the so called direct hardening, i.e. quenching with the temperature of carburisation, is permitted. From such non-alloyed steels, the products of smaller dimensions, and the products for secondary purposes that are exposed to lower impact stresses, are manufactured [1], [2], [3], [4].



**Figure 3.** Carbon content (a) and hardness (b) during carburisation [1]

The process of carburisation can be performed in the granulate, molten cyanide salts and in a gaseous medium. The process of hardening can be done directly or after the process of carburisation, so called single hardening. Direct hardening is usually applied after carburisation in salt bath, and single hardening after slow cooling in granulate or gas. The hardening is followed by the low temperature tempering in the temperature interval from 170 up to 220°C.

When choosing the steels for cementation, the determining factor is the dimension of finished product. Since it is possible to achieve a high surface hardness (that guarantees wear resistance) on all steels for cementation, there is a special request for the approach to the hardenability of core.

The main characteristic of Mn-Cr steels for cementation is that despite the high percentage of chromium, and due to the presence of manganese, they are not prone to separation of carbides in the boundary layer. The presence of manganese and chromium increases hardenability, so these steels are used for the medium size products, such as gears and shafts of machine tools. Mn-Cr steels are sensitive to overheating, and therefore, after carburisation, they are slowly cooled and re-austenitized and quenched, and then tempered [2], [3].

In order to investigate the influence of the level of carbon and nitrogen potential (on the properties of steel), the high temperature carbonitriding of Mn-Cr steel for cementation will be made, (chemical composition is shown in Table 1).

**Table 1.** Chemical composition of 20MnCr5 steel [5]

Proportion of chemical element, %	C	Si	Mn	Cr
Composition of sample	0,19	max. 0,4	1,25	1,15
According to EN 10084 : 2008	0,17÷0,22	max. 0,4	1,1÷1,4	1÷1,3

### High temperature carbonitriding

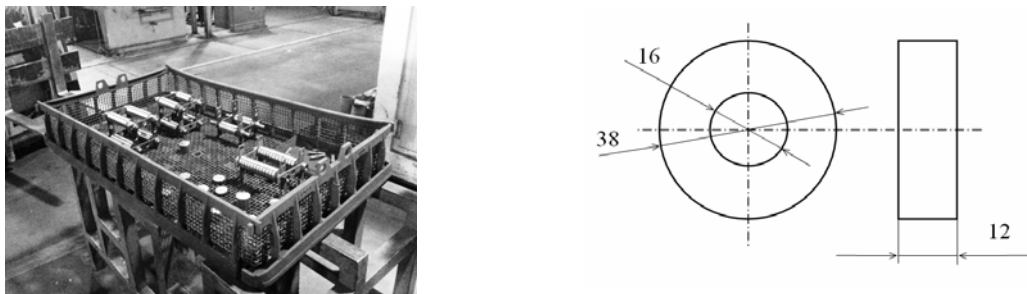
The high temperature carbonitriding is a thermochemical treatment where the surface layers of steel in the austenitic condition are enriched simultaneously by carbon and nitrogen. After hardening, the object is quenched in oil or water, and low temperature tempered [2].

The high temperature carbonitriding process is carried out between 700 °C and 900 °C, and with the lower temperature of carbonitriding, nitrogen enrichment prevails over carbon. With the increase of temperature of carbonitriding, the amount of diffused carbon is increased, and the amount of diffused nitrogen is decreased. The structure of layers is carbon-nitrogen martensite, and the outer part of the layer is a zone of carbonitride compounds. The process of high temperature carbonitriding can be performed in liquid, solid or gaseous agents. Temperature, duration of the procedure and the chemical composition of steel have the most significant effect on the process of high temperature carbonitriding.

Nitrogen in the carbonitrided edge increases wear resistance, and if a zone of compounds is created in a carbonitrided layer, fatigue strength of machine parts will be increased. The process of high temperature carbonitriding is carried out in liquid or gaseous media. Liquid media are salts for carbonitriding, which are the mixtures of alkaline cyanides, cyanates, carbonates, chlorides and activators. The high temperature carbonitriding in gas atmospheres is a process of cementation with the same gas atmosphere, which is enriched by the gas with nitrogen (ammonia  $\text{NH}_3$ ). The procedure is used as a substitute for the cementation of objects sensitive to measuring.

Unlike nitriding, the carbonitrided components are more resistant to high specific pressures and impacts. The materials that can be used for the carbonitriding are the steels for cementation, improvement, sintered iron and cast iron [3].

The test samples in a form of disc are shown in Fig. 4. The process of high temperature carbonitriding was performed in the protective atmosphere of a furnace, rich with earth gas and ammonia, at the constant parameters of temperature ( $920\text{ }^\circ\text{C}$ ) for the duration of 10 hours. The use of different values of carbon potential ( $C_{\text{pot}}$ ) and nitrogen potential ( $N_{\text{pot}}$ ) was planned.  $C_{\text{pot}}$  values were read directly on the measuring equipment which is part of the furnace. For Experiment 1,  $C_{\text{pot}} = 0.5\text{ \% C}$ , and for Experiment 2,  $C_{\text{pot}} = 1.0\text{ \% C}$ .  $N_{\text{pot}}$  values were regulated by the flow of ammonia. They were as follows:  $10\text{ \% NH}_3$  for Experiment 1, and  $5\text{ \% NH}_3$  for Experiment 2.



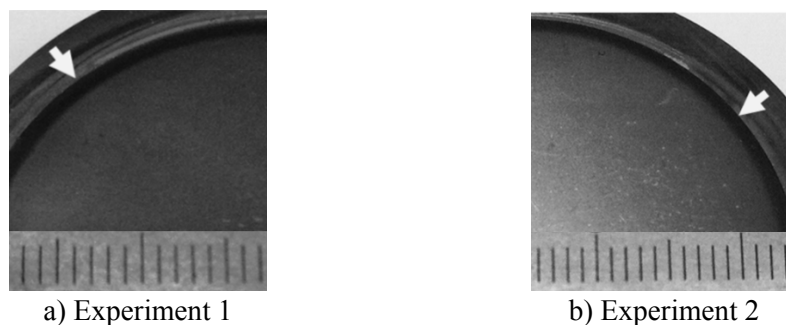
a) Test samples (prepared for the furnace)

b) Test sample (schematic representation)

**Figure 4.** Test samples for high temperature carbonitriding

## RESULTS AND DISCUSSION

Using HV1 method, the hardness measurement was performed at the cross-section of test samples (Fig. 5). A characteristic dark edge (marked by the arrows) can be noticed on the surface layer of the test samples sealed in polymer.

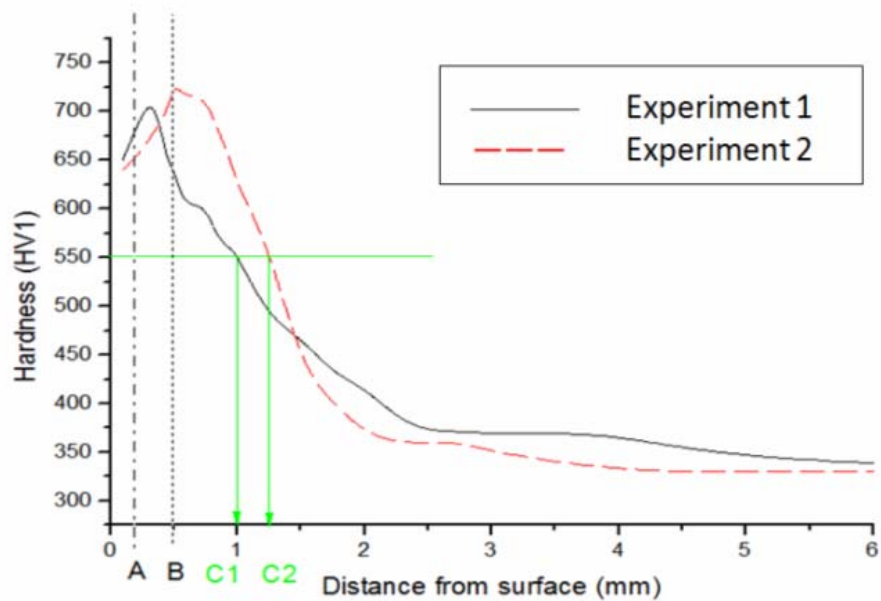


a) Experiment 1

b) Experiment 2

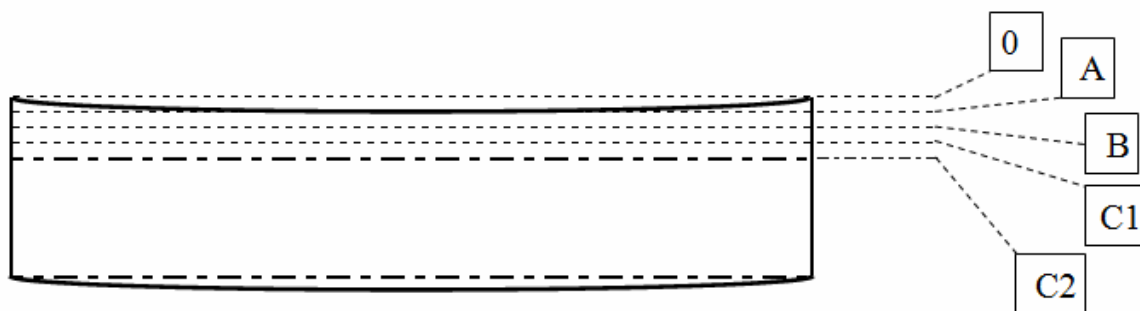
**Figure 5.** Cross-section of high temperature carbonitrided samples sealed in polymer

Fig. 6 shows the hardness measured at the cross-section of samples (high temperature carbonitrided for 10 hours). The achieved effective depth of carbonitriding was  $1\div 1,3\text{ mm}$  (represented by the points C1 and C2 in Fig. 6).



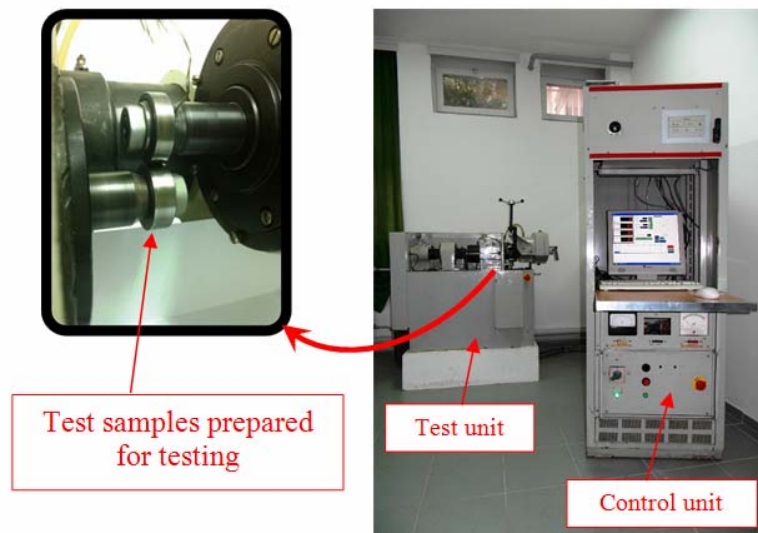
**Figure 6.** Hardness (HV1) measured at the cross-section of test samples shown in Fig. 5

In the components with the rod-shaped form, like an extraction cage knife, there is a risk of deformation at the high temperature carbonitriding, Fig. 7. From the flow of hardness, Fig. 6, it can be observed that by the use of different levels of carbon and nitrogen potential, different effective depths of carbonitriding are achieved (points C1 and C2, Fig. 6). Despite the observed differences, the high temperature carbonitriding still proves to be a very effective procedure of thermochemical treatment. It also allows the subsequent steps of grinding to correct the dimensional deviations caused by deformations up to the level of hardness marked with A for Experiment 1, and the level of hardness marked with B for Experiment 2. The letter symbols (in Fig. 7) represent the zones of hardness at depth of high temperature carbonitrided knife of extraction cage, which are taken from the diagram in Fig. 6. The maximum permitted level of wear in exploitation is up to the point C1, when using the parameters of Experiment 1, and up to the point C2, when using the parameters of Experiment 2.



**Figure 7.** Schematic representation of tolerance areas of the extraction cage knives, where the corrections by machining are allowed

Using the device SMT-1 2070 (Fig. 8), it is possible to simulate the conditions most similar to real, operating conditions.



**Figure 8.** Device for testing of friction and wear, SMT-1 2070

## CONCLUSION

The main objective of the high temperature carbonitriding is an increase of surface hardness and wear resistance. Since the dimensional criterion of seizure for the extraction cage knives is approximately 0,2 mm (point A in the diagram, Fig. 6), the high temperature carbonitriding can be applied for their production regardless of the level of carbon and nitrogen potential. With regard to the wear resistance, it is necessary to perform the additional tests of prepared samples. The obtained results will give a complete picture of the properties in conditions of wear.

They provide an adequate basis for the future research. The testing for the prepared samples is designed, making it possible to carry out the testing of wear resistance of the layers at the desired depth of layer. By monitoring the wear intensity of adhesive type with the component of sliding, it is possible to get an insight in the current properties, as well as the possibility of better synchronisation of the necessary surface properties of machine elements.

## REFERENCES

- [1] Kožuh, S., Specijalni čelici (skripta), Metalurški fakultet Sveučilišta u Zagrebu, pp. 1-57, 2010.
- [2] Krumes, D., Površinske toplinske obrade i inženjerstvo površina, Strojarški fakultet Slavonski Brod, pp. 31-114, 2004.
- [3] Novosel, M., Krumes, D., Posebni čelici, Strojarški fakultet Slavonski Brod, pp. 93-165, 1998.
- [4] Stupnišek M., Čajner F., Osnove toplinske obradbe metala, 1996
- [5] EN 10084 : 2008

## INTEGRITY ASSESSMENT OF WELDED CASING PIPES IN OIL WELL MADE OF API J55 STEEL BY HIGH FREQUENCY WELDING

Ljubica Lazić Vulićević<sup>1</sup>, Živče Šarkoćević<sup>2</sup>, Miodrag Arsić<sup>3</sup>, Aleksandar Sedmak<sup>4</sup>,  
Marko Rakin<sup>5</sup>, Zijah Burzić<sup>6</sup>, Bojan Medjo<sup>5</sup>

<sup>1</sup>High Technical School of Professional Studies, Zrenjanin, Serbia

<sup>2</sup>High Technical School of Professional Studies, Zvečan, Serbia

<sup>3</sup>Institute for Testing of Materials (IMS), Belgrade, Serbia

<sup>4</sup>Faculty of Mechanical Engineering, Belgrade, Serbia

<sup>5</sup>Faculty of Technology and Metallurgy, Belgrade, Serbia

<sup>6</sup>Military Technical Institute, Belgrade, Serbia

e-mail: [lazic.ljubica@yahoo.com](mailto:lazic.ljubica@yahoo.com)

**Abstract:** The subject of this paper is integrity analysis of welded casing pipes made of API J55 steel by high-frequency (HF) contact welding. Experimental tests of base material mechanical properties are conducted on pipes after 70 000 hours of service in an oil drilling rig. A surface crack influence on the pipe integrity was examined on hydrostatic pressured pipe with axial surface crack in the base material. Fracture behavior is examined by testing the modified compact tension (CT) specimen with a pre-crack in the base material, welded metal and heat affected zone (HAZ). The critical value of the stress intensity factor  $K_{Ic}$  is determined using the critical value of the  $J$  integral,  $J_{Ic}$ .

In addition to experimental research, based on obtained values for  $K_r$  and  $S_r$  using fracture analysis diagram (FAD), evaluation of the integrity of welded casing pipes with axial surface crack on the outer surface was performed.

**Key words:** seam casing pipes, axial surface crack, high frequency contact welding, Fracture Analysis Diagram - FAD

### INTRODUCTION

The reliability of the oil wells system is important not only because of oil exploitation, but also to preserve the environment. For those reasons, the research for the evaluation of resistance to fracture of welded casing pipe in the oil industry was conducted and an analysis of pipeline integrity using fracture analysis diagram (FAD) was made. Pipelines used in an oilfield can be made of welded or seamless pipes [1, 2]. Specifications of the pipeline, in the standard API 5CT, mostly includes properties of the pipeline, such as the dimensions of pipes and fittings, pipeline resistance to internal and external pressure, mechanical properties and chemical composition as well.

Some of the developed standards and recommendations that were discussed deal with the impact of through-wall cracks on the integrity of the pipes that are loaded by the internal pressure and bending [3]. However, the welded casing pipes can have an axial surface crack on the inside and / or outer surface, and be subjected to different loads, including internal and external pressure and axial loads (e.g. due to the weight of the structure).

Methods for assessing damage to the pipes under pressure are important for maintaining security and stability of pipelines in power plants [4-9]. Essential part of the integrity assessment of pipes is how to efficiently and accurately assess the maximum allowable pressure and determine the parameters of fracture mechanics, such as the stress intensity factor ( $K_{Ic}$ ) and  $J$ -integral of the damaged pipe. Unlike the inner circular and axial semi-elliptical surface cracks [4 to 15,17], a very limited number of studies in the field deal with determination of  $K_{Ic}$  and  $J$ -integral for pipes with external axial semi-elliptical surface cracks [13]. So far, there was no detailed 3D finite element analysis (FEM) for a wide spectrum of surface cracks on the outside of the pipe. The analyses are mainly related to the application of 3D elastic-plastic finite element analysis to determine the  $J$  integral for circular [16] and the axial surface cracks on the inner surface of the pipe [17].

In some fracture analysis diagrams (FAD), load limit of cracked pipe is used to define  $L_r$  parameter that represents the value of plastic collapse [18]. Moreover, when the structural integrity assessment is done using the R6 method [19], a reference stress is defined by the limit load. Here, the boundary load

is usually assessed for damage in high strength steels [20, 21]. A large number of existing solutions for the limit pressure of damaged pipe has been developed analytically or empirically, based on data obtained during the investigation [20]. These solutions are generally too conservative.

This paper presents the integrity analysis of welded casing pipes with axial surface crack, made of API J55 steel. Analyzed tube was in operation at an oil rig and was withdrawn during the process of repair, after a period of about 70 000 hours (8 years). This period is much shorter than the projected service life, which is up to 30 years.

By the testing of modified CT specimens, indirectly, through the critical  $J$  values  $J_{IC}$ , the critical values of stress intensity factor  $K_{Ic}$  were determined. Based on the critical value of stress intensity factor  $K_{Ic}$  for the base metal, HAZ and weld metal, the critical crack lengths were calculated. To assess the integrity of pipelines, the fracture analysis diagram (FAD) was applied. Based on the obtained values for  $K_r$  and  $S_r$  in the fracture analysis diagram (FAD) the point was marked, which is located in a safe part of the diagram. Having in mind that the FAD analysis is conservative in all of its aspects, it can be concluded that the protective welded pipe safe not only of brittle fracture, but also of plastic collapse.

## EXPERIMENTAL PROCEDURE

The present study has been carried out in order to assess the integrity of the pipe after a period of about 70 000 operating hours (8 years) in an oil rig. Properties of API J55 steel were determined on samples taken from pipes produced by HF welding. The test tubes have a diameter of Ø139,7 mm and nominal wall thickness of 6.98 mm. Chemical composition of steel API J55 is given in Table 1.

**Table 1.** Chemical composition of API J55 steel [mass. %]

C	Si	Mn	P	S	Cr	Ni	Mo	V	Cu	Al
0.2924	0.233	0.963	0.013	0.0216	0.0995	0.0579	0.0123	0.003	0.131	0.025

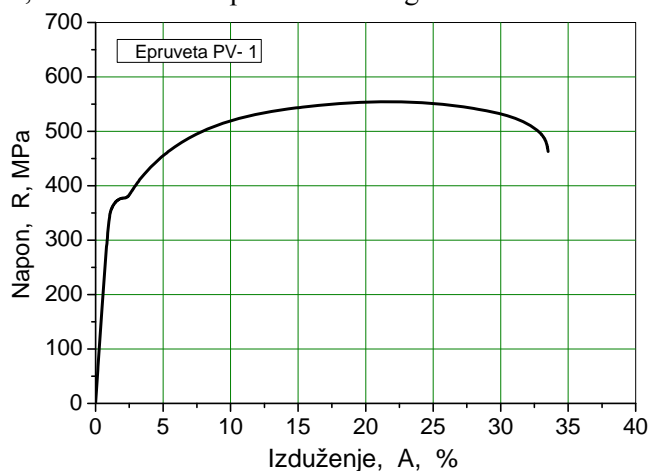
$$*Ceq=[C+Mn/6+(Cr+Mo+V)/5+(Ni+Cu)/15]=$$

$$=[0.2924+0.963/6+(0.0995+0.0123+0.003)/5+(0.0579+0.131)/15]=0.49$$

## Mechanical properties

The sampling positions for determining the mechanical properties of base metal and weld of longitudinally welded pipes are defined in the standard [23]. The shape and dimensions of specimens for testing tensile properties are defined in the standard [24]. Measurement process is performed using electromechanical testing machine SCHENCK-TREBEL RM 100, with strain (elongation) control and the load introducing speed of 5 mm / min.

Examination results of the base material tensile properties on the samples parallel with the direction of rolling are given in Table 2, and test chart is presented in Figure 1.



**Figure 1.** Diagram of stress - the elongation percentage, the specimens PR-1, the pipe from service, 20 °C



**Table 2.** Tensile properties of base metal, parallel to rolling direction (PV)

Material	Specimen	Temperature	$R_e$	$R_m$	$A$
		[°C]	[MPa]	[MPa]	[%]
Exploited	PR	20	380	562	33
Standard API 5CT			379-552	> 517	

### Fracture resistance

Welded pipe under pressure can be very sensitive to the cracks and their stable or unstable growth. Therefore, it is important to identify reliable criteria for assessing the remaining life of pressure pipes with cracks in the base metal and the weld. To better understand the initiation and the growth of cracks in casing pipes, which are exposed to high pressures in the wells, high temperatures and chemically aggressive work environment, the control parameters of material behavior at the crack tip and fracture resistance should be expressed quantitatively. Therefore, the critical value of stress intensity factor  $K_{Ic}$  and crack growth resistance curve ( $J-\Delta a$ ), are experimentally investigated [25].

### Testing modified (CT) specimens

Tests of the modified CT specimens were carried out at room temperature on a machine SCHENCK-TREBEL RM 100. Modified CT specimen thickness is  $d = 6.98$  mm (equal to the pipe wall thickness) [25]. Indirectly, through the critical  $J$  values  $J_{Ic}$ , the critical values of stress intensity factor  $K_{Ic}$ , are determined, i.e., calculated using the expression (1) and are given in Table 3:

$$K_{Ic} = \sqrt{\frac{J_{Ic} \cdot E}{1 - \nu^2}} \quad (1)$$

Using the expression:

$$K_{Ic} = 1,12 \cdot \sigma_c \cdot \sqrt{\pi \cdot a_c} \quad (2)$$

and taking into account the values of stress,  $\sigma = \sigma_c$ , (where  $\sigma_c$  is fracture stress) were calculated approximate values of critical crack length ( $a_c$ ), for base material (BM), heat affected zone (HAZ) and weld metal (WM).

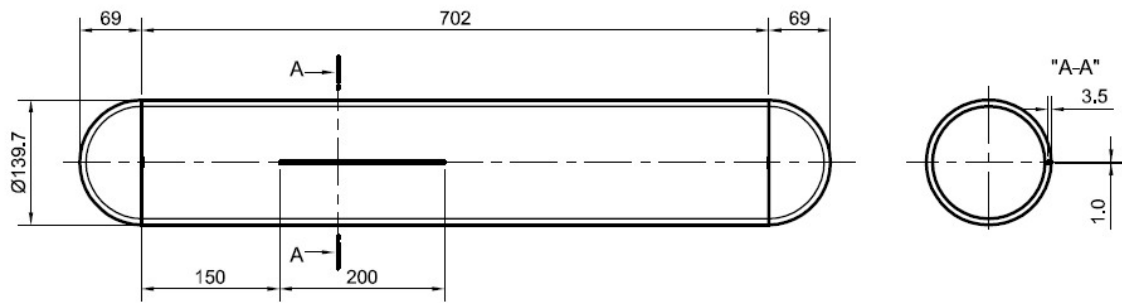
**Table 3.** The values of  $K_{Ic}$  - pipe from service

Specimen	Temperature [°C]	$J_{Ic}$ [kJ/m]	$K_{Ic}$ [MPa m <sup>1/2</sup> ]	$a_c$ [mm]
BM-NR-E	20	35.8	91.4	14.4
HAZ-NW-E		48.5	106.4	19.6
WM-NW-E		45.7	103.3	18.5

Based on the obtained values of  $K_{Ic}$  for the base metal, HAZ and weld, the lowest resistance to crack initiation and propagation has the basic material.

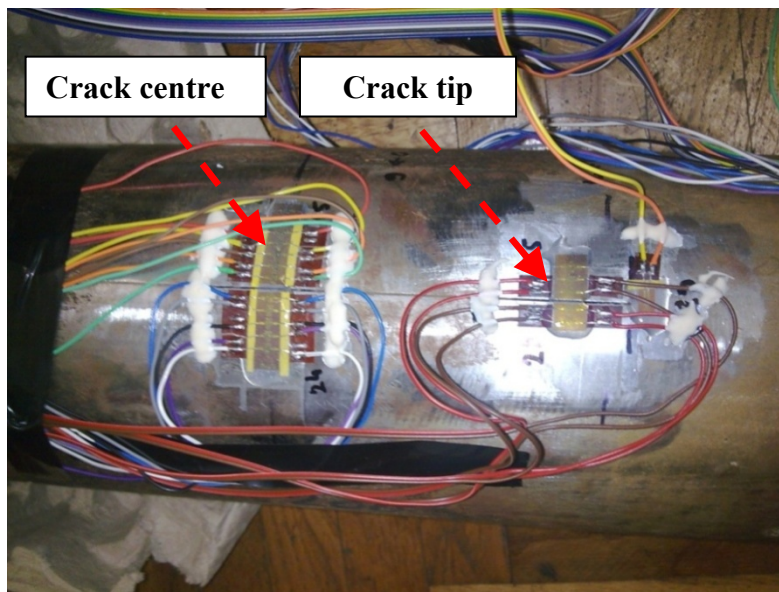
### STRUCTURAL INTEGRITY ASSESSMENT OF PIPES WITH AXIAL SURFACE CRACK

Tests were conducted on pressured vessels with axial surface crack in the base metal, Figure 4. The vessel is made of seam casing pipes from exploitation. On the outer surface of the pipes, an axial surface crack in the base material was introduced by means of electro erosion, with dimensions:  $a=3,5$  mm i  $2c=200$  mm.



**Figure 2.** Vessel with an axial surface crack on the outside surface

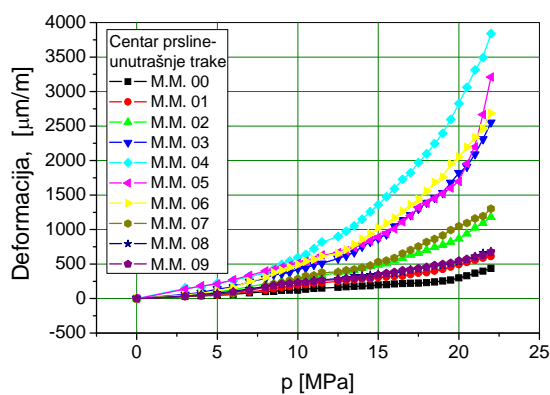
Pipe prepared for hydrostatic pressure testing is shown in Fig. 3.



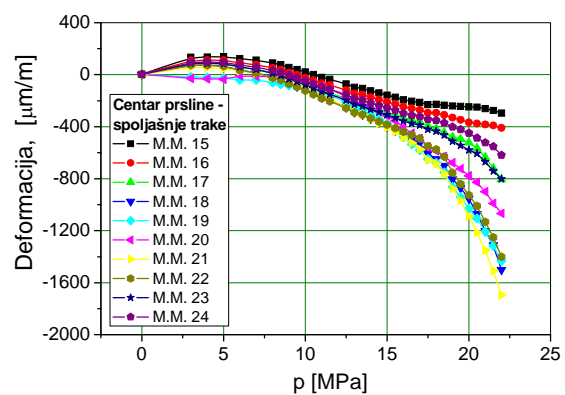
**Figure 3.** The appearance of pipes prepared for testing

Pressure during testing was increased successively in increments of 1 MPa to the pressure of 8 MPa, and then by 0.5 MPa to 22 MPa pressure, and with the use of strain gauges LY 11-6/120, manufactured by HBM, the strains were registered at the measuring points [26].

Dependence deformations of the test pressure  $p$  diagrams are shown in Fig. 4 to 7.



**Figure 4.** Dependence strain-pressure, internal tape - crack middle



**Figure 5.** Dependence strain-pressure, external tape - crack middle

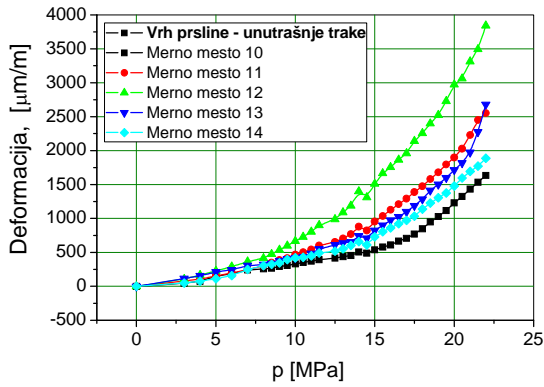


Figure 6. Dependence strain-pressure, internal tape - crack tip

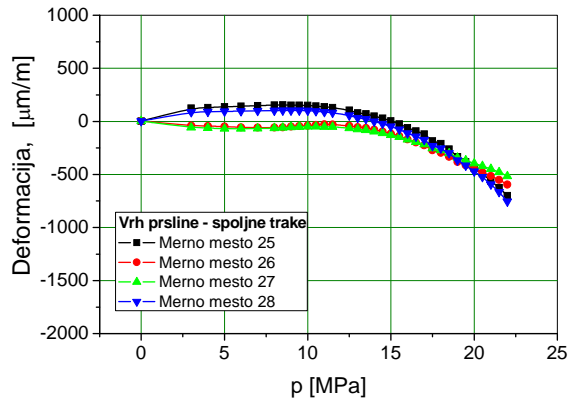


Figure 7. Dependence strain-pressure, external tape - crack tip

### Fracture analysis diagram – FAD

Structures made of ductile materials are not subjected to brittle fracture but to the plastic fracture if they are overloaded. The mechanism of plastic fracture (collapse) is not included in the projected CTOD curve, and for its analysis a more general approach is required. Therefore, the concept with two failure criterion was introduced, to describe the mutual interaction of brittle fracture and plastic collapse, implemented through the fracture analysis diagram (Failure Analysis Diagram - FAD) [27]. Starting point of this diagram is modified strip yield model for through crack in an infinite plate, which connects the effective stress intensity factor  $K_{eff}$  with distant stress [28]:

$$K_{eff} = \sigma_Y \sqrt{\pi a} \left[ \frac{8}{\pi^2} \ln \sec \frac{\pi \sigma}{2 \sigma_c} \right]^{1/2} \quad (3)$$

In real structures yield strength  $\sigma_Y$  should be replaced with collapse stress  $\sigma_C$ , which in addition to the material, depends on the geometry of the structure, including crack. The next step in the modification of FAD is an expression of effective stress intensity factor in no dimensional form as  $K_{eff}/K_I$ :

$$\frac{K_{eff}}{K_I} = \frac{\sigma_c}{\sigma} \left[ \frac{8}{\pi^2} \ln \sec \frac{\pi \sigma}{2 \sigma_c} \right]^{1/2} \quad (4)$$

As a final step, dimensionless variables  $S_r = \sigma/\sigma_c$  and  $K_r = K_I/K_{Ic}$  are defined, which represents the abscissa and ordinate in the modified FAD, Figure 5, and the equation becomes:

$$K_r = S_r \left[ \frac{8}{\pi^2} \ln \sec \left( \frac{\pi}{2} S_r \right) \right]^{-1/2} \quad (5)$$

If the material is totally ductile, the structure breaks in plastic collapse  $S_r=1$ , while for the failure of the structure of completely brittle materials  $K_r=1$ . In all other cases there is interaction between plastic collapse and brittle fracture, the  $K_r$  and  $S_r$  values are less than 1, and the pairs of corresponding values are the limit curve, as shown in Figure 8. When it is taken that  $K_{eff}$  to be equal to material fracture toughness,  $K_{Ic}$ , and the  $K_r$ , is determined according to:

$$K_r = \frac{K_I}{K_{Ic}}$$

For the calculation of  $S_r$ , only primary stresses are taken, because secondary stresses are not affected on the collapse of the structure.

Using the manual,  $K_I$  factor, for the geometry of Fig. 2, the following expression is given:

$$K_I = \sqrt{\frac{\pi a}{Q}} \frac{pR_i^2}{R_o^2 - R_i^2} \left[ 2G_0 + 2\left(\frac{a}{R_i}\right)G_1 + 3\left(\frac{a}{R_i}\right)^2 G_2 + 4\left(\frac{a}{R_i}\right)^3 G_3 \right]$$

(6)

a constant  $Q$  is calculated by:

$$Q = 1 + 1,464 \left(\frac{a}{c}\right)^{1,65}$$

where the  $G_j$  values depend on  $a/c$ ,  $a/t$  and  $t/R_i$  and are given in [13]. The relevant values of  $G_j$ , for this study obtained by interpolation and extrapolation are:

$$G_0 = 1,584 \quad G_1 = 0,839 \quad G_2 = 0,600 \quad G_3 = 0,480$$

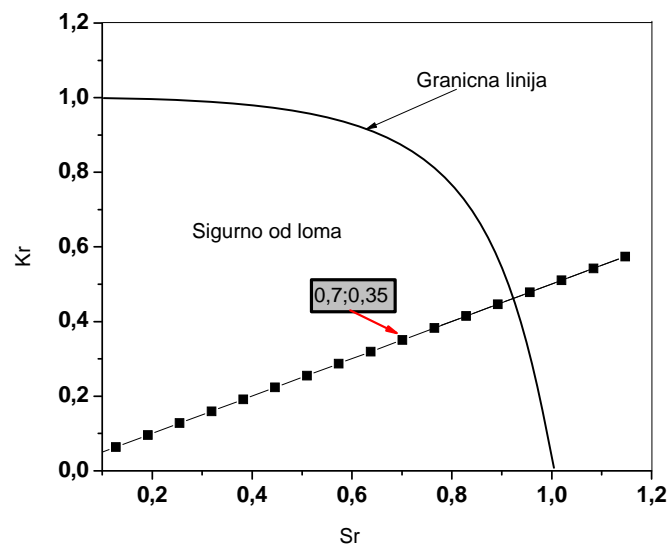
At the initial depth  $a = 3,5$  mm and crack length  $2c = 200$  mm it is obtained:

$$Q = 1,0058 \quad \text{ i } \quad K_I = 32,067 \left[ \text{MPa}\sqrt{\text{m}} \right] \quad \text{ pa je } \quad K_r = \frac{K_I}{K_{Ic}} = \frac{32,067}{91,4} = 0,35$$

Tension in the net section  $\sigma_n = 1,5pR/t$ , where the factor of 1.5 was taken because of section weakening by crack, length 3,5 mm in thickness 6.98 mm (50%), and is obtained:

$$S_r = \frac{2\left(\frac{1,5pR}{t}\right)}{(R_{eH} + R_m)} = \frac{2\left(\frac{1,5 \cdot 22 \cdot 69,85}{6,98}\right)}{(380 + 562)} = 0,7$$

The obtained values for  $K_r$  and  $S_r$  in the fracture analysis diagram (FAD) marked the point with coordinates (0.7; 0.35), which is located in a safe part of the diagram, Figure 8.



**Figure 8.** Fracture analysis diagram (FAD) for the pipe with axial surface crack on the outer surface

## CONCLUSION

In this work, using fracture mechanics, integrity assessment of welded seam casing pipes with axial surface crack on the outer surface of pipes, made of API J55 steel was performed.

Based on the critical value of stress intensity factor  $K_{Ic}$  for the base metal, HAZ and weld metal, the critical crack lengths were calculated. The results indicate that the basic material has the lowest resistance to crack initiation and propagation.

Having in mind the conservative analysis of FAD in all of its aspects, it can be concluded that the welded casing pipes are safe not only of brittle fracture, but also of plastic collapse.

It is important to notice that the FAD provides a simple analysis of integrity that can reliably determine whether the welded casing pipe, and thus the casing string, is safe from failure, under condition that the geometry and the load presented on the conservative way.

On the other hand, if you can not prove integrity; it does not mean that the casing string is useless, but that they need additional, more complicated analysis.

## Acknowledgements

We thank to the Ministry of Science and Technological Development of Serbia for the financing of work on this topic within the project EVB: TR 35002.

## REFERENCES

- [1] Arsić M. Choice of steel for welded tubes production. *Welding Weld Struct*, 2002; 47:33-37,
- [2] Šarkoćević Ž, Arsić M, Rakin M, Sedmak A. Fabrication of welded tubes by high strength steel and quality indicators. *Struct Integr Life*, 2008; 8:81-98.
- [3] Sanjeev S, Ramachandra Murthy DS. On the accuracy of ductile fracture assessment of through-wall cracked pipes, *Engineering Structures*, 2007; 29:789–801.
- [4] Kumar V and German MD. Elastic-plastic fracture analysis of through-wall and surface flaws in cylinders. EPRI Report, NP-5596, 1988.
- [5] Zahoor A. Ductile fracture handbook. Novetech Corp, 1991.
- [6] R6: Assessment of the integrity of structures containing defects, revision 4. British Energy Generation Ltd., 2001.
- [7] ASME, Rule for in-service inspection of nuclear power plant components - ASME Boiler and Pressure Vessel Code, Section XI (1996).
- [8] API, API RP579 - Recommended Practice for Fitness-For-Service. American Petroleum Institute, 2000.
- [9] Miller AG. Review of limit loads of structures containing defects. *International Journal of Pressure Vessels and Piping*, 1988; 32:191-327R
- [10] Jones MR. & Eshelby JM. Limit solutions for circumferentially cracked cylinders under internal pressure and combined tension and bending. *Nuclear Electric Report TD/SID/REP/0032*, 1990.
- [11] Delfin P. Limit load solutions for cylinders with circumferential cracks subject to tension and bending. SAQ/FoU Report 96/95, SAQ Kontroll AB, Stockholm, Sweden, 1998.
- [12] Kim, YJ, Shim DJ, Huh, NS and Kim, YJ. Plastic limit pressure for cracked cylinders using finite element limit analyses. *International Journal of Pressure Vessels and Piping*, 2002; 79:321-330.
- [13] Raju IS and Newman JC. Stress-intensity factors for internal and external surface cracks in cylindrical vessels. *Journal of Pressure Vessel Technology*, 1982; 104:293-298.
- [14] Bergman M. Stress intensity factors for circumferential surface cracks in pipes. *Fatigue and Fracture of Engineering Materials and Structures*, 1995; 18:1155-1172.
- [15] Fett T. and Munz D. *Stress Intensity Factors and Weight Functions*. Computational Mechanics Publications, 1997.
- [16] Kim YJ, Kim JS, Kim YJ. Non-linear fracture mechanics analyses of part circumferential surface cracked pipes. *Internal Journal of Fracture*, 2002; 116:347-375.

- [17] Kim YJ, Kim JS, Park YJ and Kim YJ. Elastic-Plastic Fracture Mechanics Method for Finite Internal Axial Surface Cracks in Cylinders. *Engineering Fracture Mechanics*, 2004; 71:925-944.
- [18] Zerbst U, Hamann R and Wohlschlegel A. Application of the European flaw assessment procedure SINTAP to pipes, *International Journal of Pressure Vessels and Piping*, 2000; 77:697-702.
- [19] Ainsworth RA. The assessment of defects in structures of strain hardening material. *Engineering Fracture Mechanics*, 1984; 19:633-642.
- [20] Miller AG. Review of limit loads of structures containing defects. *International Journal of Pressure Vessels and Piping*, 1988; 32:191-327.
- [21] Kim YJ, Shim DJ, Nikbin K, Kim YJ, Hwang SS. and Kim JS. Finite element based plastic limit loads for cylinders with part-through surface cracks under combined loading. *International Journal of Pressure Vessels and Piping*, 2003; 80:527-540.
- [22] Tonković Z, Skozrit I. Elastoplastic Analysis of External Axial Surface Cracks in Tubes. *Proceedings of the ICCES'04, International Conference on Computational & Experimental Engineering and Sciences*, Tadeu, A., Atluri, S. N. (eds.), Madeira, Portugal, 26-29 July 2004.
- [23] API Spec 5CT, Specification for casing and tubing, American Petroleum Institute, 2002.
- [24] ASTM A370-94, Standard test methods and definitions for mechanical testing of steel products, 1994.
- [25] Šarkoćević Ž, Arsić M, Medjo B, Kozak D, Rakin M, Burzić Z, Sedmak A. Damage level estimate of API J55 steel for welded seam casing pipes. *Strojarstvo: J Theory Appl Mech Eng*, 2009; 51:303-11.
- [26] Harrison RP et al. Assessment of the Integrity of Structures Containing Cracks. *International Journal of Pressure Vessels and Piping*, 1975; 3:77-137.
- [27] Harrison RP et al. Assessment of the Integrity of Structures Containing Cracks. *International Journal of Pressure Vessels and Piping*, 1975; 3:77-137.
- [28] Dugdale DS. Yielding in Thin Sheets Containing Slits, *J. Mechanics and Physics of Solids*, 1960; 8:100-104

## MASTERING PRODUCTION OF CORED WIRES FOR REPAIRING OF MACHINE PARTS

Nikola Bajić<sup>1</sup>, Darko Veljić<sup>1</sup>, Marko Rakin<sup>4</sup>, Slobodan Stojadinović<sup>3</sup>, Jasmina Pekez<sup>3</sup>,  
Mihajlo Mrdak<sup>2</sup>

<sup>1</sup>Techno experts d.o.o – Research and Development Center, Belgrade, Serbia

<sup>2</sup>Faculty of Technology and Metallurgy, University of Belgrade, Karnegijeva 4, Belgrade,  
Serbia

<sup>3</sup>Technical Faculty „Mihajlo Pupin“ Zrenjanin, Serbia

<sup>4</sup>Research and Development Center, IMTEL komunikacije a.d Belgrade, Serbia  
e-mail: ihis@eunet.rs

**Abstract:** This paper presents the results of development and mastering production of flux-cored wires intended for wide layer surfacing of machine parts using the EPP procedure. Selected were two metallurgical qualities of flux-cored wires, which are the most commonly used in application in repairing machine parts. One of the two is the quality of low alloy flux-cored wire which is used as an intermediate-tampon zone, and the other metallurgical quality is a high alloy flux-cored wire forming wide layer surfacing on the working surface of designed hardness and wear resistance.

**Keywords:** flux-cored filler wire, fusion welding, EPP- method surfacing

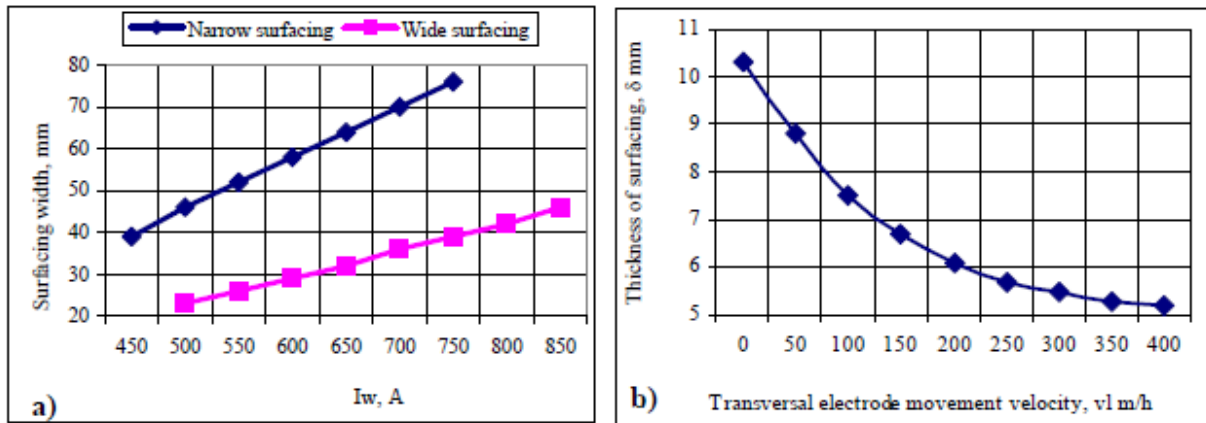
### INTRODUCTION

This paper presents the results of development and introducing onto production of flux-cored wire from a narrow steel strip produced in Serbia, with a core of a mixture of metal powders. Flux-cored wire is designed for use with the EPP procedure (submerged arc welding) for surfacing in a wide layer of new and for repairing of worn machine parts. Surfacing of cylindrical parts in a broad layer with electrode flux-cored wire that oscillates provides opportunities for the application of currents of over 600A, which is reflected in the increase in the width of the surfacing deposit (50 to 100 mm), Figure 1a.

In the process of EPP surfacing the electrode flux-cored wire is given lateral oscillation of adequate speed that allows the surfacing to be performed in the joint melt pool. Amplitude of oscillation is determined depending on the required width of surfacing layers. The increase in line speed of transverse oscillations of the flux-cored electrode wire contributes to more than two times lower depth of penetration of the base metal in comparison to surfacing with flux-cored wire without oscillation, Figure 1b.

When surfacing in a wide layer the thermal cycle is more favorable than in surfacing in a narrow weld therefore reducing the demand for pre-heating massive parts. When surfacing large cylindrical parts in a wider layer in powder shielding increased current above 800A does not worsen the forming of the surfacing layer. Increased current limits only the depth of penetration and excessive heating of parts [1-3].

Possibility of an increase in productivity is even higher when surfacing cylindrical parts of relatively small diameter (50 to 250 mm). Liquid pool becomes wider but significantly shorter compared to surfacing without oscillation, the diagram in Figure 1a. This allows a significant increase in welding current threshold value, at which the molten metal remains on the surface of the machine part. Retention of the liquid metal on the part's surface during welding in a broader layer depends upon: the curvature of the surface, the mass of surfacing metal per unit of time, the configuration of weld pool, heat conducting conditions and physical-chemical properties of the liquid metal and slag.



**Figure 1.** Dependence of the surfacing width (a) in function of the surfacing current strength ( $I_w=800A$ ,  $U=40V$ ) and the oscillation of the welding head: 1 - without oscillation, 2 - with oscillation ( $a=50mm$ ). Dependence of the depth of the weld (b) of the base metal on the velocity of transverse oscillation of the electrode wire[1]

Flux-cored welding wire for submerged arc hardfacing can be roughly divided into soft and hard. Softer flux-cored wires are designed for tough and medium hard welds, which are subject to wear due to rolling. The pure weld metal can, without major difficulties and problems be processed by removing shavings, and due to its good toughness that type of flux-cored wire can be used in multi-layer surfacing of highly worn parts.

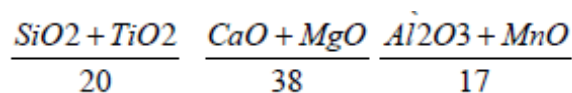
Hard flux-cored wires are generally used when there is impact action, combined with abrasive wear. The harder the alloy the lower its resistance to an impact or compressive load, and the higher the resistance to abrasive wear. Weld metal made from hard flux-cored wires contains hard wear resistant carbides and nitrides in part, stored in the tough base mass of the metal, which provides significant resistance. Weld metal of such alloys is workable only by grinding and has a hardness of 53 to 62 HRC.

The basis for the development and introduction to production of new metallurgical quality flux-cored wires designed for surfacing in a wide layer are the significant annual costs of repair welding of rollers, conveyor rollers and crane wheels in Serbia.

The subject of this paper is the development of the two selected metallurgical qualities to standard (API A5.17) that are purchased from manufacturers Weldclad, regarding quantity mostly used are: Weldclad 3 (hardness of HRC 33-48) and Weldclad 9 (hardness 120-140 HV) [1,2-4,6].

## EXPERIMENTAL

The development and experimental production includes two selected metallurgical quality flux-cored wires (soft - Weldclad 9 and hard - Weldclad 3) that have the highest quantity rate in repairing machine parts. One of the two is the quality of low alloyed flux-cored wire marked IHIS FCW-9S (hardness 120-140HV), which is used as an intermediate-buffer zone, and the second metallurgical quality is high alloyed flux-cored wire marked IHIS FCW -3H (hardness of HRC 33-48) which forms a weld in a broad layer on the working surface of which high wear resistance is expected. On the line for calibration of narrow steel strip flux-cored wire a diameter of 4.0 mm is formed, and then multistage drawing leads to a final diameter of 3.2 mm, intended for EPP surfacing (submerged arc welding). Experimental surfacing in a wide layer is made with an EPP device Lincoln Electric DC-1000 with the application of a universal agglomerated powder to standard AWS A5. 17-89 EM 13K (from the manufacturer Weldclad) basic composition:





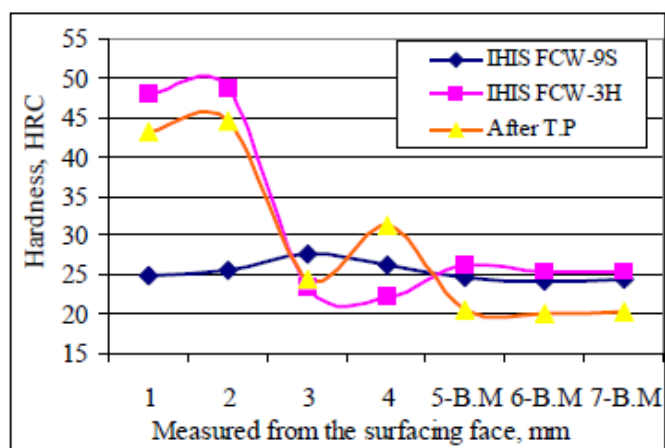
Surfacing was carried out at the firm Zmaj and Profiweld - Smederevo on the device with oscillating movement of the welding head, forming a surfacing weld with a width of 60 mm and a thickness of  $3 \times 5 = 15$  mm. The roller is welded with three layers-passes, the first of which was made with a soft flux-cored wire making the transition (buffer) zone and two final working coats made with alloyed flux-cored wire[4,6].

## RESULTS AND DISCUSSION

The chemical composition of the wide surfacing was investigated. Chemical analysis of the weld face was performed by pre-grinding off a layer 1.5 mm thick, and examining the chemical composition. The mean values of the results of chemical analysis of the weld metal for, low alloyed flux-cored wire marked IHIS FCW-9S (hardness 120-140HV), and the other metallurgical quality high alloyed flux-cored wire marked IHIS FCW-3H (hardness of HRC 33-48) are given in Table 1.

**Table 1.** The results of chemical analysis of weld performed with two mastered qualities of flux-cored wires IHIS FCW-9S and IHIS FCW-3H.

Flux-cored wire mark	Chemical composition of weld metal %											
	C	Mn	Si	S	P	Cr	Ni	Mo	Cu	Nb	V	Ti
IHIS FCW-3H	0,12	1,00	0,61	0,011	0,019	12,5	2,65	0,79	0,07	0,17	0,15	0,01
IHIS FCW-9S	0,10	1,08	0,53	0,012	0,018	0,05	0,02	0,34	0,07	0,01	0,01	0,01



**Figure 2.** Changes in hardness of surfacing weld performed using EPP procedure with flux-cored wires quality: IHIS FCW-9S and IHIS FCW-3H

The surfacing weld hardness test was performed on the longitudinal cross section of a vertical line from the weld face to the base metal of the surfacing weld. The microhardness results of the surfacing weld from both electrode wires and hard surfacing after thermal treatment are shown in the diagram, Figure 2.

## CONCLUSION

The aim of this paper is presenting the results of mastering and introducing into production two metallurgical qualities of flux-cored wires which are mostly present in application for repair of machine parts. The two metallurgical qualities are: the low alloyed flux-cored wire marked IHIS FCW-9S which is used as an intermediate buffer zone, and the other is the high alloyed flux-cored wire marked IHIS FCW-3H which forms a broad layer surfacing on the working surface of pre-designed hardness and wear resistance.

The achieved results of development and mastering production of flux-cored wires intended for surfacing in a wide layer with the EPP process presents certain technical changes in regard to the metallurgical qualities of the flux-cored wires from the manufacturer Weldclad, which is twice as thick steel strips for making the jacket of the flux-cored wire, which contributes to the increase of current strength, higher intake of metal along the length of the melted wire, thus increasing the productivity of surfacing.

Results obtained in experimental surfacing in a wide layer of cylindrical parts show that:

- The mastered two metallurgical qualities of flux-cored wire intended for submerged arc welding (EPP) process in a wide-layer have good welding-technological properties and can be safely recommended for industrial applications;
- The resulting surfacing weld in a wide layer of 60 mm meets the requirements and technical conditions in terms of quality and mechanical-technological properties;
- Surfacing in a wide layer of cylindrical parts with two new qualities of flux-cored wires show good economic effects due to increased current and speed, and thus the productivity of the surfacing with good quality of weld surface causing a decrease of the share of machining.

### Acknowledgements

This work is supported by the Serbian Ministry of Science and Technological Development (project number TR34016" Development of covering and core production technology based on local raw materials for manufacturing of special coated electrodes designed for steel arc welding"& TR 35002" Development of new methodologies for revitalizing turbine and hydro mechanical equipment of hydroelectric power stations depending on the cause of degradation of the material").

### REFERENCES

- [1] D.M. Kušnerev, S.F Rižej, V.A.Lapčenko, V.V.Golovko, V.S. Rogal: Avtomatičeskaja svarka, Nr.12(261),(1974), p.48-50.
- [2] A. Author, V. Ilić, „Methods of welding-technological properties testing of flux cored wire“ International symposium, Budva, (1986), p. 139-141.
- [3] Pernis, J. Kasala, D. Žabecka., METALURGIJA 52 (2013) 3, ISSN 0543-5846, p.352-354.
- [4] N. Bajić, D. Bajić, D. Veljić, M. Rakin., METALURGIJA, ISSN 0543-584652(4) (2013), p.465-468
- [5] BY N. M. Ramini de Rissone, H. G. Svoboda, E. S. Surian, and L. A. de Vedia, Influence of Procedure Variables on C-Mn-Ni-Mo Metal Cored Wire Ferritic All-Weld Metal., WELDING JOURNAL,(2005), p. 139-148s.
- [6] Bajić N, M. Rakin, S. Stojadinović.: „Surfacing of the worn part of crane wheel with flux cored wire”,ZAVARIVANJE I ZAVARENE KONSTRUKCIJE, WELDING&WELDED STRUCTURES UDK/UDC:621.791, ISSN 0354-7965, ,Beograd (4/2006), p.147-150.

## EXPLOSIVE METAL HARDENING

Rade Katana<sup>1</sup>, Nikola Bajić<sup>2</sup>, Slobodan Stojadinović<sup>3</sup>, Jasmina Pekez<sup>3</sup>

<sup>1</sup>Trimetal, Belgrade, Serbia

<sup>2</sup>Techno experts d.o.o – Research and Development Center, Belgrade, Serbia

<sup>3</sup>Technical Faculty „Mihajlo Pupin“, Zrenjanin, Serbia

e-mail:katana.rade@gmail.com

**Abstract:** This paper presents the procedures and results of hardening of parts made of Hadfield steel. The characteristic of these steels is that they harden in conditions of excessive impact loads as a result of transformation of the structure of the working surface from austenite to martensite. The purpose of this hardening is to prevent pronounced initial wear of parts made of this steel, until the moment when the operating conditions themselves continue to harden it. The effect of the applied hardening procedures is an increase in service life of parts of construction and mining machinery, 1.5-2 times.

**Key words:** Hadfield steel, explosion depth hardening, explosive deformation, work hardening, railway switch.

### INTRODUCTION

Explosion hardening is significantly different from the methods applied in static conditions. Hardening is caused by the wave nature of propagation of the disturbances in metal, short-lived process and high pressure values, which reach hardening depth that can not be achieved by other methods and without the use of special equipment.

Metal, under the influence of the shock wave, changes density and mechanical properties, whereby in the material there is an increase in properties of strength, a decrease in ductile properties and a significant increase of physical characteristics, such as: electrical, thermal and magnetic. Usually for contact method hardening of metals, high brisance explosives are applied with detonation velocities of 7-8 km/sec and density of 1.5-1.7 gr/cm<sup>3</sup>, whereby pressures of 20-40 GPa are generated in the shock wave front (Fig. 2).

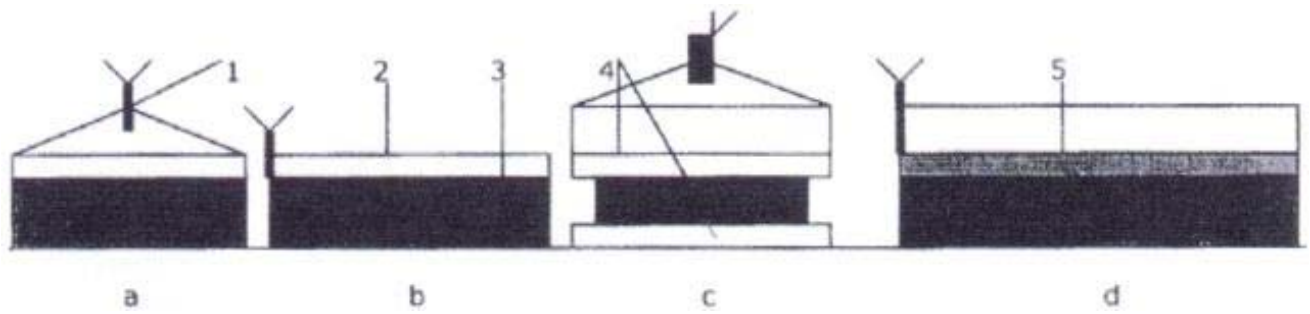
The subject of hardening is high manganese Hadfield steel, which in conditions of pronounced impact or crushing changes its structure and hardens. On delivery this austenitic steel is soft. It is produced by quenching steel in water at approximately 1050°C. Quenched steel is tough, has good cold deformation properties but is mechanically difficult to process [1-6].

### MATERIAL AND METHODS

In practice various schemes for hardening of metals are used. In principle those are contact methods, where the metal and explosives are in direct contact or hardening takes place through a porous layer. The metal is hardened under the influence of the front of a flat or sliding shock wave to achieve greater depth of hardening (Fig. 1). Often in these hardening schemes combined explosive charges are applied, where a lower explosive is laid directly in contact with the metal (Fig. 5).

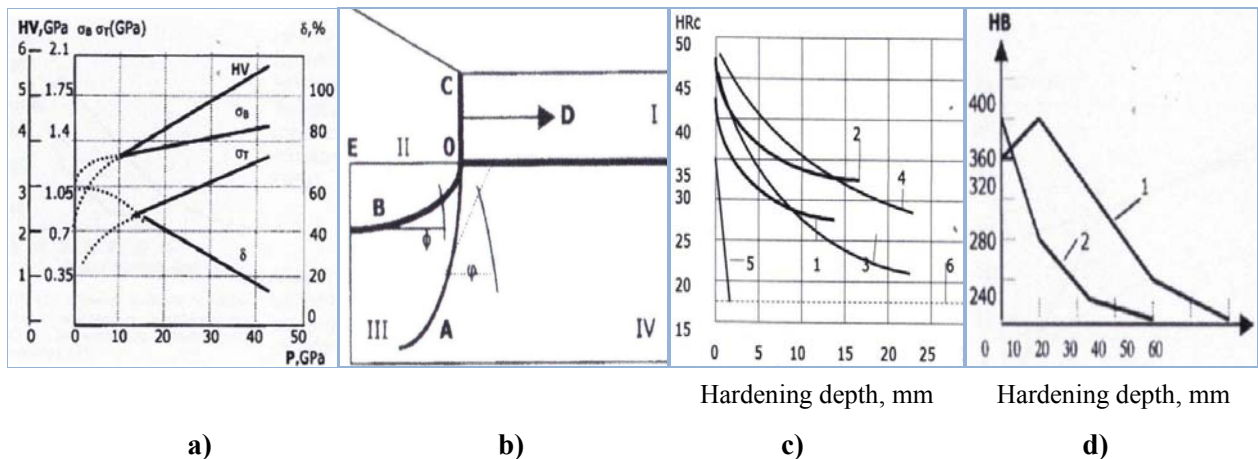
The effect of high dynamic pressure leads to phase transitions in metal (transition from one state of crystal lattice to another), with rapid changes in metal density. The peculiarity of phase transitions is in their unusually high rate of formation. Under the influence of the shock wave new phases are formed in a fraction of a microsecond, both in processes without diffusion and those that require mass transfer.

Today more and more frequently the method of hardening through porous layers is used, with the application of low brisance - less expensive explosives. The porous layer, in addition to protecting the metal surfaces, enables prolonged effect of gaseous explosion products of metal, when the amplitude of the waves increases significantly [1-3,5].



**Figure 1.** Schemes of hardening of metals: flat (a) and sliding (b) shock wave, repeated hardening using metal plates (c), hardening of metal through the porous layer (d) where, 1–electric detonator, 2-explosive, 3-metal being hardened, 4-metal plates used for hardening, 5-porous layer

Schemes with repeated hardening mean that the metal which is to be hardened is placed between metal plates, and due to the difference in acoustic resistance of the metal and the plate the shock wave is repeatedly reflected and returned into the metal hardening it repeatedly (Fig. 2c) [4-7].



**Figure 2.** Changes of mechanical properties of Hadfield steel [7]:

- (a) Changes of mechanical properties of Hadfield steel under the influence of a shock wave, pressure 4-40 GPa
- (b) Hardening using an oblique shock wave: I-explosive, II-blast products, III-area of metal with load, IV-metal without load
- (c) Repeated hardening of Hadfield steel: 1, 2, 3, 4-number of hardenings, 5-hardening with strikes of a pneumatic hammer, 6-initial hardness of steel
- (d) Changes in hardness of Hadfield steel: 1- application of a combined explosive charge, 2-one type of explosive

In practice, we have implemented manufacturing of a number of bimetallic wear-resistant combinations, from which we produce cladding panels for baskets in loading and receiving limestone bunkers. Distinct requirements demanded mastering of a series of procedures for hardening working pieces of equipment in mining and construction [8].

**EXPERIMENTAL**

- **Manufacturing of bimetal for lining baskets in crusher plants**



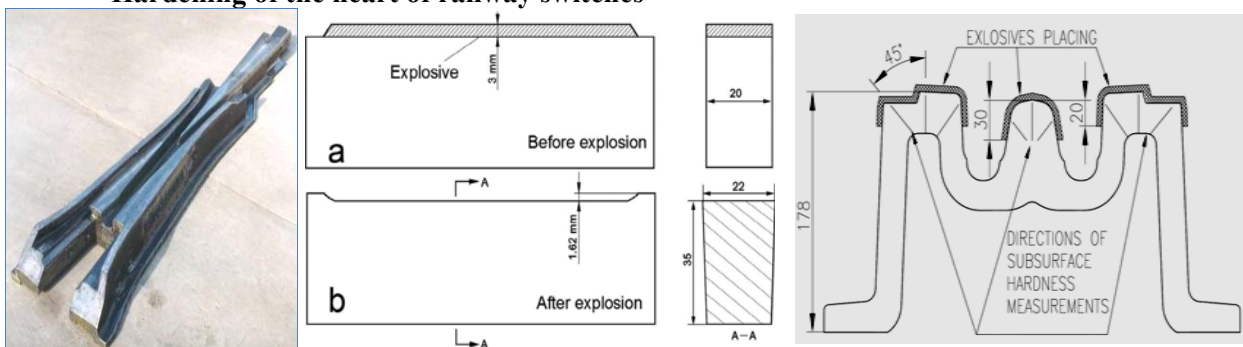
**Figure 3.** Production of bimetal (Č0563 + Č3160) for lining of loading baskets

- **Procedure of hardening loading bucket teeth in mining and construction**



**Figure 4.** Hardening of loading bucket teeth

- **Hardening of the heart of railway switches**



**Figure 5.** Hardening of railway switches

• Procedures for hardening of the hammer in crusher for crushing limestone



Figure 6. Hardening of the hammer for limestone crushers

Hardening process and analysis of the results of hardening a mill hammer BL-V

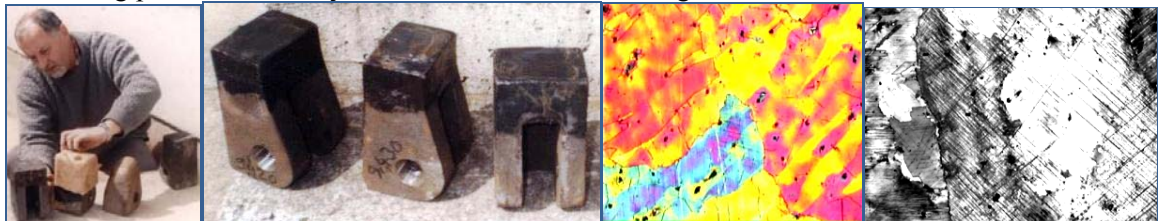


Figure 8 The process of hardening a mill hammer BL-V and the microstructure of the base material (core) of the hammer and the hardened surface of the hammer ČL.3160: dark lines-martensite  
 Condition: cast, quenched and hardened by explosion

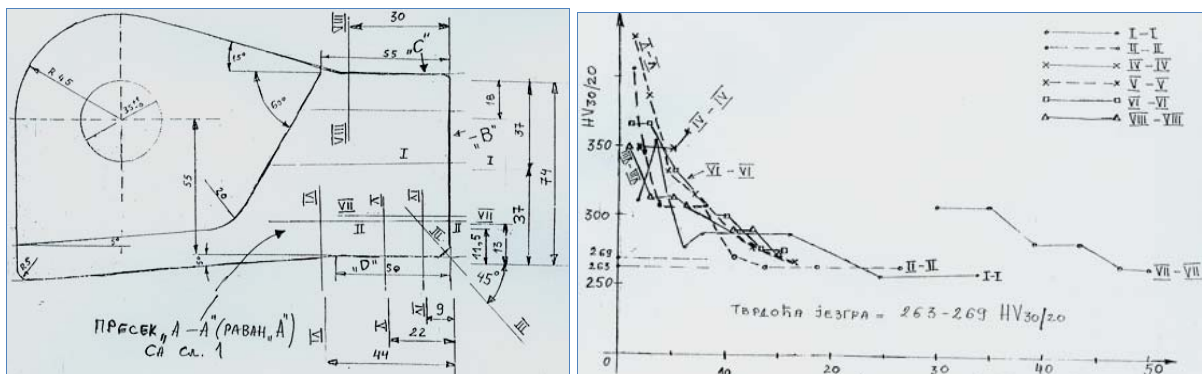


Figure 9. Schematic overview of hardness measuring in plane 'A' cross section 'A-A'

**Table 1.** Cross section II-II

Distance from surface "B" in mm	1,3	2,4	4,0	6,2	8,2	11,0	14,0	18,7	26,5
HV <sub>30/20</sub>	406	343	308	308	308	269	263	263	263
Corresponds to HRC	41,3	33,7	30,7	30,7	30,7	25,7	24,5	24,5	24,5

**Table 2.** Cross section V-V

Distance from surface , "D" in mm	1.5	3.0	4.5	7	12.7	17
HV <sub>30/20</sub>	429	385	337	315	269	263
Corresponds to HRC	43.5	39.3	33.6	31.6	25.5	24.5

## RESULTS AND DISCUSSION

- The highest hardness value of 406 HV was measured directly at the frontal surface "B".
- Based on the measuring results in cross section VII-VII at a distance of 30-35 mm from surface "B", that is at a distance of 13 mm from surface "D" measured hardness values were greater than 300 HV.
- The main micro constituent in the structure is austenite. In addition to the austenite, present are carbide phase particles (dark individual elongated particles) and dark particles that are non-metallic inclusions and gas pores.
- Based on the microstructure test results the conclusion is that the appearance of the microstructure correlates well with the results of hardness testing.

## CONCLUSION

- Explosion hardening is significantly different from the methods applied in static conditions, where under the influence of a shock wave, the density and mechanical properties of steel are changed, with a lifetime increase by 1.5-2 times for components made of Hadfield steel.
- With explosion energy depth hardening is achieved which can not be achieved by other methods and without the use of special equipment.
- In the interest of a more economical procedure and partly deeper hardening, we apply hardening through adequate porous layers using cheaper-powder explosives.

## Acknowledgements

This work is supported by the Serbian Ministry of Science and Technological Development (project number TR34016")

## REFERENCES

- [1] А.А.Дерibas, Физика упрочнения и сварки взрывом. Новосибирск. Наука, 1980.
- [2] И.Д.Захаренко. Сварка металлов взрывом. Наука і техніка, 1990. 205с.
- [3] Ю.А. Конон, Л.Б.Первухин, А.Д.Чудновский. Сварка взрывомю Машностроение.1987.216с.
- [4] Mustafa Acarer, Behcet G`ulenc. Cladding of High Mn Steel on Low C Steel by Explosive
- [5] Welding, Turkish J. Eng. Env. Sci. 27 (2003) , 431 - 434.
- [6] Petr Havlíček, Petr Nesvadba. Application of explosive hardening on railway infrastructure parts. Metal 2011, 18. - 20. 5. 2011, Brno, Czech Republic, EU
- [7] Ming Zhang, Bo LV, Fucheng Zhang\* and Xiaoyong Feng, State Key Laboratory of Metastable Materials Science and Technology, Yanshan University, Qinhuangdao, 066004 China.
- [8] Ing. Petr Havlíček, Ing. Josef Zbořil, Ph.D. Wear of the railway turnout crossings made of explosive hardened Hadfield steel. METAL 2013, May 15th – 17th 2013, Brno, Czech Republic
- [9] Rade Katana, Otvrdnjavanje metala niskobrizantnim eksplozivom primenom inertnih prosljajaka, Patent YU48843.

## **SESSION 4: Maintenance**



## STRESS ANALYSES OF CONNECTION OF TURNTABLE WITH CHASSIS OF ARTICULATED BUS USING SOFTWARE PACKAGE CATIA AND COMPARATIVE METHODS

Ivana Vasović<sup>1</sup>, Marko Ristić<sup>1</sup>, Mirjana Opačić<sup>2</sup>, Mirko Maksimović<sup>3</sup>

<sup>1</sup>Institute Goša, 35, Milana Rakića str., Belgrade, Serbia

<sup>2</sup>Mechanical Faculty, University of Belgrade, Serbia

<sup>3</sup>Water Works and Sewerage, Belgrade, Serbia

e-mail: [ivana.vasovic@institutgosa.rs](mailto:ivana.vasovic@institutgosa.rs)

**Abstract:** This paper deals with the static structural analysis of an articulated urban bus chassis, carried out with the Finite Elements Method and measurement stress distribution by strain gauges. The purpose of this work is to simulate and find out where are critical areas into construction. Accordance to standards requirements is to achieve a fast and easy redesign based on an optimization of structure taking into account fast solution of problems. A thorough interaction with the customer company allowed the authors to adequately define the loading scheme and to constrain the structure properly. Analyses with FEM parameters have been run, in order to achieve an adequate compare with stress strain results obtained measuring by strain gauges. Whole experiment is defined in several phases. The results between numerical simulation and experiment have good matching, about 8-10%, which is pretty good for these types of experiments. This experiment show that is possible to use finite element analyses for improving the critical part of the bus construction. Eventually, the customer has been notified of critical issues and the related suggested improvements.

**Key words:** Numerical simulation, Optimization, Stress State, Strain Gauges

### INTRODUCTION

Damage of metal parts and constructions is a complex process which takes place with effect of one or more mechanisms, such as: surface damages (corrosion, wear); distortion (elastic and plastic) and fracture.[1] Fracture, which is a most severe form of material damage, is under influence of numerous factors, such as: mechanical stresses, temperature, composition and atmospheric conditions, shapes and dimensions of a part or construction; structure and properties of material and quality of surface [1-3]. Analysing the results, obtained by numerical simulation and strain gauges were performed with the redistribution of critical stresses, and proposal for the structure optimization. The comparative analysis methods have been provided the precise prediction of failure appearance and made possible to define the preventive measures [4]. A complete characterization of the system implies a better understanding and behavior of construction in the presence of failure, and the evaluation of their resistance to crack initialization and growth. The vehicle which is under investigation is an articulated bus characterized by a length of 18 m, realised by the joining of two chassis (Figure 1), capable of carrying up to 130 passengers and with a mass at full load of about 25,000 kg. Urban buses, as most part of passenger vehicles, are built around a tubular chassis that bears both the weight of the vehicle itself and the weight of passengers and luggage.

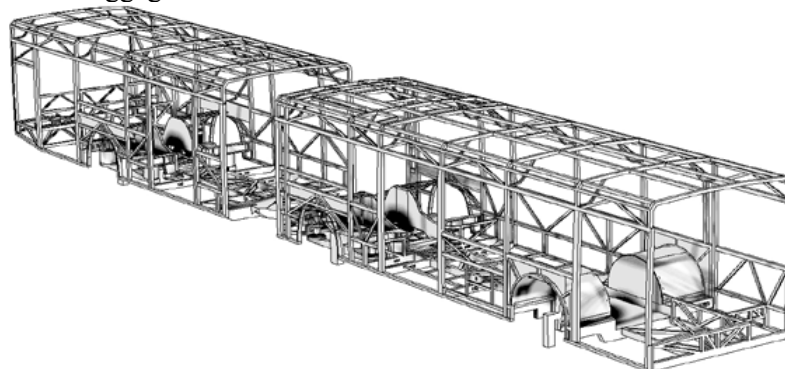


Figure 1. Model of articulated bus

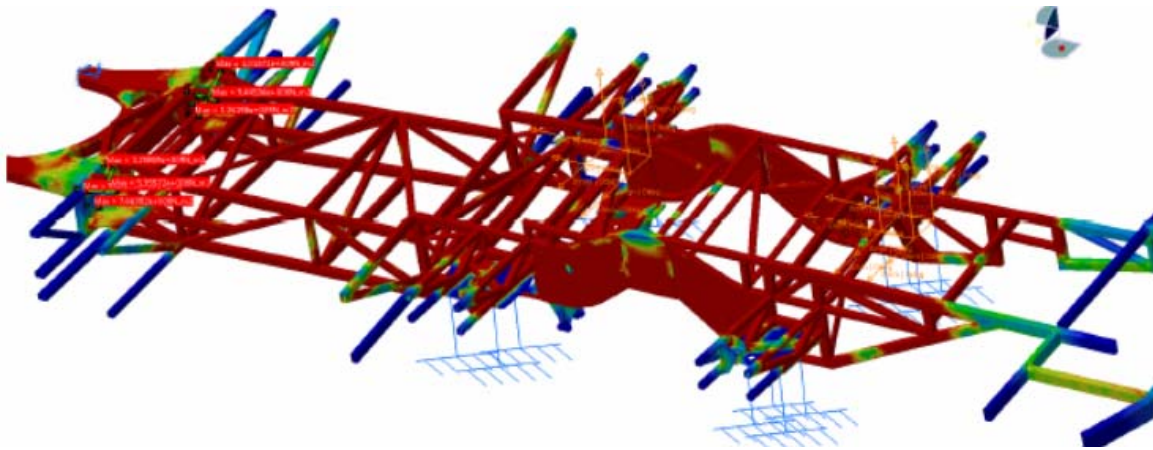
A chassis model shall also meet precise stiffness requirements and good connection between in order to allow a safe drive under the most diverse traffic conditions.[6] Problem during the exploitation of articulated bus, there was a weakening of links between chassis and bus turntable after a while, a fracture of screws that form the connection. The aim of this analyses is to determinate the cause of the fracture screws on the front and back of the bus chassis turntable marks screws and nuts that are determine the cause of the fracture was carried out, according to the usual practice methodology, adapted to existing conditions and the type of test defects. Because it came to a frequent failure and accidents due to fracture of screws, there had to be done a thorough analysis of the problems and to propose solutions of the design improvement, that was a problem with the whole series, not only one bus. Constructor of the bus is suggested inserting a wedge that will take some of the strain on the chassis link instead of screws that are carrying the entire link. It was necessary to prove whether this is the optimal solution. To avoid installation of wedges and testing of the buses, there should have been found an appropriate testing mechanism, therefore is FEM analysis using software package CATIA selected and measuring the existing stress condition using the strain gauges. According to literature survey, the studies on this similar fitting process have been rarely reported, while most research efforts have focused on the numerical analysis of screwconnection [3–6], its failure analysis [6, 7], and the optimum shape design for improving the tightening force [7, 8]. It is because the failure in the screwconnection may, but frequently, lead to the overall failure of the screwed structural systems. The fastening force of the screw is governed by a number of parameters such as the material properties and the shape and dimensions of turntable and type of connection with chassis.[9]Traditionally, the selection of design and redesign parameters has relied on the cost- and time-expensive experiments in a trial and error manner.

## EXPERIMENTAL PART AND DISCUSION

The aim of this study is to determinate the cause of the fracture screws which connected the front and back of the bus chassis. The experiment was done in several phases, which serve to give a complete state of stresses, which is shown as optimal and as very reliable tool for redesign of bus. In order to obtain reliable and accurate results, it is necessary to consider all the loads acting on the critical combination of chassis with the turning. For screws that are the main problem in these connections that after a while there is a loosening of the connection and fracture. A very important detail is that the screws are correctly tightened to torque, which in itself brings great preloading stress into the screws so that the screw before the operation has already been pre-stressing.

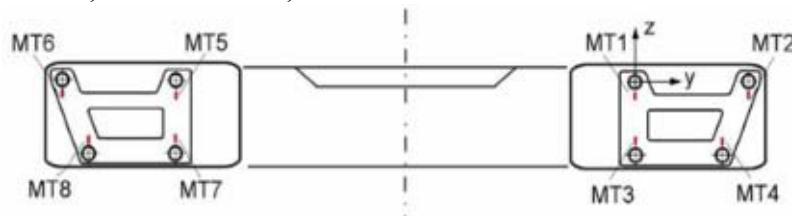
On the start of experiment is done generation and production of CAD models which is used for numerical simulation in software package Catia. Model is faithful to the original design. The modeling of the bus structure is made with data collected from producer of bus. In the first phase of the experiment initial numerical simulation was done with determined loads in order to locate critical areas of the construction and that would also be input for the later phase of the experiment. A thorough interaction with the customer company allowed the authors to adequately define the loading scheme and to constrain the structure properly.

The analysis is limited to the chassis and turntable of the vehicle. During this also very important in the numerical simulation was included force of tightening the screws which included very large initial stress in the connection of turntable. The inputs for the finite element analysis are all the loads which acting on bus. These loads acting on the bus during the driving are self-weight of bus, passenger weight, luggage, engine weight, fuel weight and extra tire weight. Firstly in the experiment done initial numerical simulation was done with maximum allowed loads in order to see the critical points of the construction and that would also be opening for the second phase of the experiment. The first set of numerical simulations were done not for the purpose of obtaining the values of stress but to visually determine the weakest region in the structure on which goal is to prepare places for bonding strain gauges. The figure 2 presents the model of turntable and critical locations with maximum stress. The simulation shows that maximum stress is obtain in the steam of screw.



**Figure 2.** Connection of turntable with the chassis and areas of maximum stress

In this phase was done measuring of the stress using strain gauges which are positioned at critical locations of the construction that we have identified in the first phase. It was done by measuring the stress in screws area for connection of the turntable and the front of the bus and turntable and rear of the bus. For the purpose of experiment a cause of experiment that is important to measure the real stress state in the screws, which is shown, that is critical element in construction.



**Figure3.** Position of measuring gages on the turntable

Measuring of stress is performed using strain gauges at 10 measuring points show on Figure 3 (on this figure is shown the 8 measuring places, only). Disposition of measuring points is shown in Figure 5. In order to compensate the effect of temperature on the accuracy of the measurements, each measuring tape associated with another compensation measuring tape in a semi-conductorSpeed is measured by an optical encoder OMRON Figure (4a). From transmission ratio of the gear shaft which is, is derived vehicle speed.



**Figure 4.** (a) Optical sensor for measuring speed; (b) the data acquisition device Spider 8

Accelerations were measured in the longitudinal, lateral and vertical directions using tri-axial sensor Silicon Designs 2460-010. Acceleration sensor is placed on the floor of the bus. All sensors and strain gauges are connected with two parallel connected measurement acquisition device SPIDER 8 productions HBM (Figure 6b). Measurements have been made in the case of an empty bus mass 15760 kg and bus tanked with sandbags to the total weight of 25420 kg. Before the measuring on the polygon and in driving cases, were measured impact of tightening the screws with the specified torque of 400 Nm, and the change of the stress state at the measurement place.

**Table 2.** Measured Stress State of screws

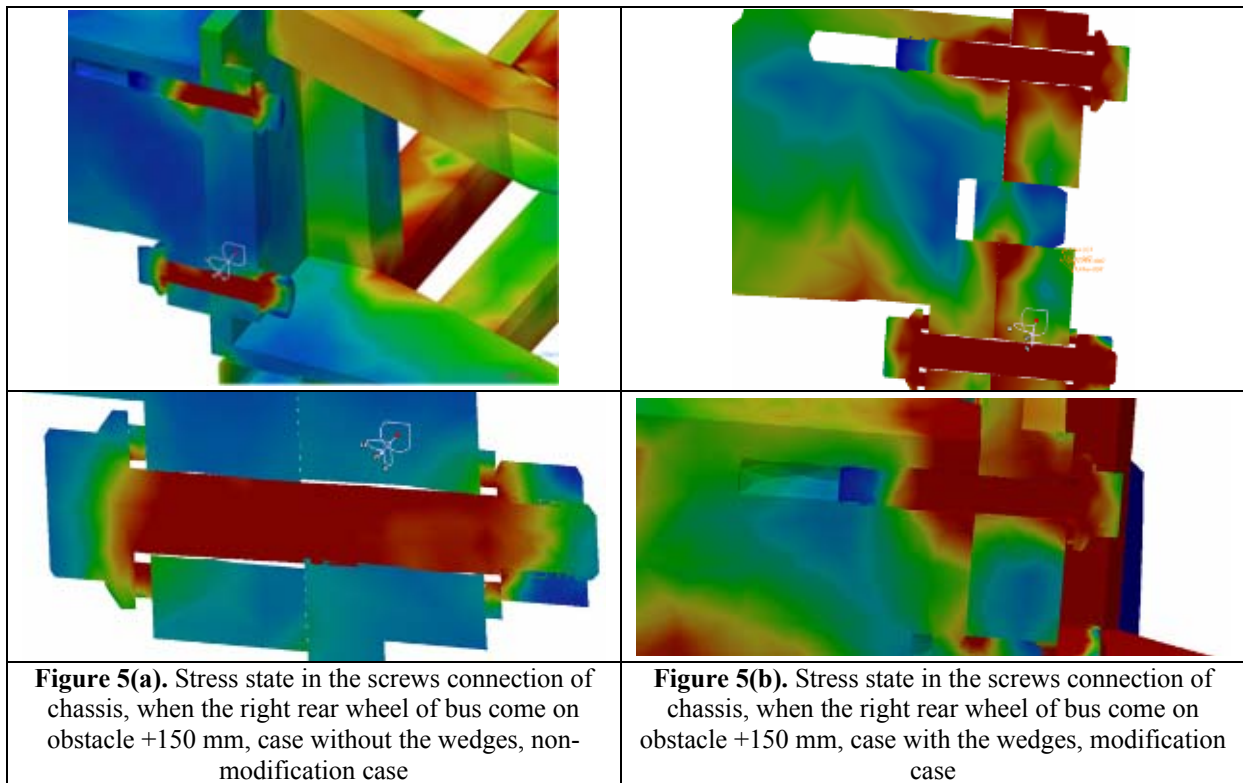
Measuring Tapes	Stress $\Delta\sigma$ from tightening $\sigma$ [N/mm <sup>2</sup> ]	Stress in case elevated left wheel in the central axle and right wheel in rear axle Emptybus – two sensors	Stress in case elevated left wheel in the central axle and right wheel in rear axle - Empty bus single sensor on right side
MT1	35,0	-14,1	-6,8
MT2	27,8	-0,6	-0,3
MT3	42,0	14,1	10,3
MT4	32,0	17,5	12,5
MT5	32,3	6,6	-1,0
MT6	44,8	10,7	6,4
MT7	52,0	-38,7	-9,0
MT8	44,9	-39,0	-9,7
MT9	17,2	-0,2	-2,2
MT10	8,1	1,0	-0,1

Measuring the impact of this torque was done while the bus was on the crane, and then is done release and then tightening of the screws one by one. Stress state of strain gages depend on dominantly tightening a screw near which the gauges is, the change of the stress state of each gage under the influence of proper torque nearest screw is shown in Table 2. After the influence of torque test on the stress state in the area of screws, measurements were carried out on the polygon. It is simulated the case of climbing and crossing the deformations on the road with a height of approximately 150 mm. The measurements were carried out for the following cases: 1. obstacle of 150 mm, climbing one wheel of the middle axis; 2. obstacle of 150 mm, climbing one wheel of the rear axis; 3. obstacle of 150 mm, climbing one wheel of the middle axis, with the simultaneous onset of diagonal climbing one wheel of the rear axis.

Table 2 also shows the results of measurements with an empty bus while climbing the left wheel of the middle axle and the right wheel on the rear axle is on a camber of 150 mm. Level control left and right sides of the vehicle was independent from the two sensors. It may be noted that the stress shown on the diagrams are not fully stabilized, but the gradient of further increase is very small. Table 2 also presents the results of measurements during the transition from level control with two sensors to adjust the height of a single sensor. An empty bus was standing on the swells, so here was elevated left wheel in the central axle and right wheel in rear axle by about 150 mm. Strain gauges was not possible to measure the stress state in the steam of screws, but in place just above and below the screw. So, in this section for comparison and validation of numerical simulation, set the sensors to measure the stress on the numerical simulation of the same places where were placed and the measuring tape.

During this experiment it was important to verify that the numerical simulation is authoritative for such complex analysis and whether it will give reliable results. All previous tests and simulations were carried out on bus chassis which was not modified, without wedges. The goal was validation results obtained using numerical simulations. That is why in this phase is done numerical simulation under the same conditions and loads that were on the test polygon. Comparison of stress condition was done. Repeated numerical simulation of chassis with loads was done, and those were identical, during simulated load during the measurements, that were at the test site. The results have good matching- the difference is about 8-10%.

The final phase is to apply this method and stress analyses of bus chassis in a modified state when beside the screws, and wedges receive load also. The numerical simulation of rising and lowering the rear left and right wheel of the bus here is presented. The numerical simulation is done for equal working conditions of the bus like in experiment; it is simulated that wheels of bus coming on the prepared obstacles. During the raising is performed the measurements. In Figure 5(a) is shown, the analysis done for the turntable assembly with screws to the original non modification state. Where is visible, that the shearing is dominant and uneven in the cross sections of the screw.



Combined loads are visible and uneven distribution of stresses in the cross section of the screw. The main load are shearing and bending, and tension on screw. On Figure 5(b) is shown, the stress analysis for the turntable assembly with screws to the modified state with wedges. Where is visible, that the shearing was reduced to the minimum. In table 5 is shown comparative overview of the stress value in screws, (Rising of right sides of bus +150mm) with wedges and without it. The stress value decreased quite, for one order of magnitude, which shows, that the solution with the wedge is much better, because it reduces the screw load.

**Table 5.** Comparative overview of the stress value in Screws, (when rising right and left sides) with widgets and without it.

Number of screws	Rising of right sides of bus +150mm		Rising of left sides of bus +150mm	
	Without wedges	With wedges	Without wedges	With wedges
	Stem of screw[N/m <sup>2</sup> ]	Stem of screw[N/m <sup>2</sup> ]	Stem of screw[N/m <sup>2</sup> ]	Stem of screw[N/m <sup>2</sup> ]
1	9,691e+008N_m2	1,032e+008N_m2	1,103e+009N_m2	1,123e+008N_m2
2	1,046e+009N_m2	1,014e+009N_m2	8,447e+008N_m2	9,172e+008N_m2
3	1,265e+009N_m2	1,262e+009N_m2	6,885e+008N_m2	5,994e+008N_m2
4	9,856e+008N_m2	9,445e+008N_m2	7,425e+008N_m2	7,945e+008N_m2
5	1,114e+009N_m2	1,259e+009N_m2	7,711e+008N_m2	9,312e+008N_m2
6	8,315e+008N_m2	9,27e+008N_m2	1,056e+009N_m2	1,036e+009N_m2
7	6,388e+008N_m2	5,356e+008N_m2	1,445e+009N_m2	1,396e+009N_m2
8	7,128e+008N_m2	7,664e+008N_m2	9,465e+008N_m2	8,953e+008N_m2

## CONCLUSION

In this paper is shown that results of the numerical simulation can be taken as a relevant in process redesigning products in this case redesign and redistribution of stress. Here is also shown the proof that is FEM simulation is reliable, by control of values of stress by strain gauges and comparing results. All of these methods are an advanced technology that allows making better decisions and

maintain control of the process of product development, modification and its development. The measurements and results are the basis for further analysis, to establish the correlation between measured stress state, by using strain gages and stress state or load that are appearing and unadjusted screw connections with a turntable connection solutions on turnable bus chassis. The whole experiment shows that weakest point in the construction is screws which connect the turntable with chassis of bus. Stress measurement is carried out by using strain gages, which are placed, as close as possible to screws which connect the turntable with chassis of articulated bus, while maintaining their proper setting, above or below the screw connections. The measurement was performed at the test site, during driving with empty and loaded bus. Having in mind that the measuring tapes are physically placed relatively far from the place where the maximum stresses occur in the screw connection, and that the gradient of the stress drop in the zone is quite large, it can be concluded that the measured stresses are relatively high, indicating the occurrence of relatively high load of elements of connection. FEM is done in Catia software. Simulation was done for cases of lifting and lowering right and left rear wheel of the bus. Simulation was done for cases with and without wedges in connection of turntable with chassis of articulated bus. Results of numerical simulation shows that the stress at several measuring points are several times lower than in the case with no wedges. These types of analysis, redesign has relied on the cost- and time-expensive experiments, main idea is to find critical locations on the construction applying these method.

### Acknowledgements

This work was financially supported from National Projects TR 34028 and TR 35045 that are funded by Ministry of Education, Science and Technological Development of Republic of Serbia.

### REFERENCES

- [1] Ivana Vasovic, Strength analysis of filament wound composite tubes; Хемијска индустрија, 64 (2010) 239-245.
- [2] Kutin Marina , Prokolab Milan , Ristic Marko Alil Ana , Gligorijevic Bojan; Determination and analysis of the dynamic loaded screws by structural analysis, fractography and numerical simulation; International conference Structural Integrity of welded structures, plenary lectures; July 11-12 2013. Timisoara, Romania
- [3] Dario Croccolo, Massimiliano De Agostinis, Nicolò Vincenzi; Structural Analysis of an Articulated Urban Bus Chassis via FEM: a Methodology Applied to a Case Study; Strojništvinski - Journal of Mechanical Engineering 57(2011)11, 799-809, DOI:10.5545/sv-jme.2011.077
- [4] Selim Hasagasioglu, Koray Kilicaslan, Orhan Atabay, Ahmet Güney Vehicle dynamics analysis of a heavy-duty commercial vehicle by using multibody simulation methods, Int J Adv Manuf Technol (2012) 60:825–839, DOI 10.1007/s00170-011-3588-8
- [5] J. R. Cho & D. Y. Lee & W. S. Yoo & O. K. Lim, Numerical investigation of screw fitting and fastening forces by elastoplastic finite element analysis, Int J Adv Manuf Technol (2013) 66:71–81, DOI 10.1007/s00170-012-4306-x
- [6] Marina Kutin, Slavica Ristic, Mirjana Puharic, Ivana Vasovic and Milan Proklab, Testing of butt welded thin steel sheet by classical method and thermography, 4th International conference, ISIM, Romania, 10-11 June 2010.
- [7] Ruding Loua, Jean-Philippe Pernot, Alexei Mikchevitch, Philippe Vérona, Merging enriched Finite Element triangle meshes for fast prototyping of alternate solutions in the context of industrial maintenance, Computer-Aided Design 42 (2010) 670-681.
- [8] Hong-Seok Park, Xuan-Phuong Dang, Structural optimization based on CAD\_CAE integration and metamodeling techniques, Computer-Aided Design, 42 (2010) 889-902.
- [9] R. A. Ibrahim, C. L. Pettit, Uncertainties and dynamic problems of screwed joints and other fasteners, Journal of Sound and Vibration 279 (2005) 857–936.

## SOFTWARE SUPPORT FOR THE MANAGEMENT OF LUBRICATION

Vlado Krunic<sup>1</sup>, Aleksandar Ašonja<sup>2</sup>, Momčilo Krunic<sup>3</sup>

<sup>1</sup>Faculty of Natural Sciences and Mathematics, Banja Luka

<sup>2</sup>The Serbian Academic Center, Novi Sad, Serbia

<sup>3</sup>Faculty of Technical Sciences, Novi Sad, Serbia

e-mail: [krunicm@gmail.com](mailto:krunicm@gmail.com)

**Abstract:** This paper presents a software package LMSoft that automate the process of lubrication management of technical systems that is a part of the information system of preventive maintenance. Featured software package is the result of years of research by the field of information systems and the design of control systems in the process industry. The function of preventive maintenance is increasingly represented in a new form known as proactive maintenance processes where lubrication play a key role. Processes include lubrication and periodic quality control of lubricating oil, the results represent a significant technical support to the technical diagnostics. By automating management processes at the same time improving lubrication preventive maintenance and technical diagnostics.

**Key words:** software support, lubrication management, preventative maintenance, technical diagnostics

### INTRODUCTION

Software package for managing processes lubrication LMSOFT (Lubricant Management Software) is designed to support organizations with different profiles that have technical systems with a large total number of lubrication where manual control was very difficult and unprofitable. The software package includes a database that is used to manage the process of preventive maintenance, and also for storing the results of technical diagnostics. Technical diagnostics and lubrication are key elements of preventive maintenance, which are modeled using FMEA (Failure Modes and Effects Analysis) methods. FMEA method is used in the LMSOFT in a particular area of the real work to identify all of the lubrication and to store the relevant attributes in the database.

### MAINTENANCE – CONCEPTS AND TECHNOLOGIES

Maintenance of the technical systems (TS) represents a set of procedures and activities which is main purpose to prevent states of failure and recovering from fails to the state of normal work in the shortest possible time and with less expenditure in the given environmental conditions and work organization. The purpose of maintenance is to increase the effectiveness of the production process, which will result, that costs per unit of production will decrease. Maintenance TS should be considered as a function of the primary production, because it contributes to the production to takes place in a rational manner with optimum reliability level of TS in the company [1].

Basic concepts of maintenance include: preventive, corrective (reactive) and combined maintenance. Preventive maintenance, which aims to prevent or delay the occurrence of failure, can be implemented in several ways.

By default, two basic types of preventive maintenance [2]:

- The first case refers to the periodic preventive maintenance that is based on information on the reliability of the system (division of the time of work until failures of the observed system or part).
- The second case, also known as maintenance of the state or predictive maintenance is based on the monitoring of parameters that represent the state of the observed system.

Predictive maintenance resulting in the reduction of the number of unexpected failures, increasing reliability and reducing direct and indirect costs of maintaining TS [B]. A latest innovation in the field of predictive maintenance is the so-called proactive maintenance, where various technologies are used in order to extend the life of the machine and for the practical elimination of corrective maintenance. The main part of the program is a proactive analysis of the causes of failure of machinery or part thereof. The causes of the failure of the machines in this way can be removed, and

the failure mechanisms gradually will be eliminated with engineering approach. Corrective maintenance is maintenance concept, which means that maintenance procedures are carried out only when there is a failure occurrence. Combined maintenance is implemented as a part of the plant maintains preventative, while the remaining part of the maintenance procedures carried out as it comes to failure. Choice of area of preventive and corrective maintenance of all technical systems is in function of optimization in order to reduce the maintenance costs of the product [3]. Maintenance technology is directly linked to the development and production technology, and contains procedures and ways of their implementation, including [4,5]:

- basic maintenance by the operator,
- preventive periodic inspection and replacement of parts,
- random inspections regulated by the regulations and laws,
- lubrication of the technical system,
- technical diagnostics (determining the actual state of the system),
- repair and restore of the worn parts,
- identification and elimination of the weak points of the system (innovation) and
- general periodic repairs and modernization.

For the implementation of the maintenance technology it is necessary to have a clear concept that contain answers to many questions: When is a need for maintenance, why is maintenance carried out, what procedure should be used and in what order, in what part of the system maintenance works should be carried out, who will be the perpetrators [6].

### **TECHNICAL DIAGNOSTICS**

Determining the condition of the machines is a key issue in the process of its maintenance. It is necessary to monitor changes in the condition of individual parameters of components and machine elements, which eventually lead to a drop in performance and to failure. Technical diagnostics (TD) checks the correctness of the TS, TD checks the working capacity of the TS, TD checks the functionality of the TS. Diagnostic controls are divided in to the next sections [7]:

- Identification of the working state – the state assessment using appropriate instruments and observation with predefined criteria permitted and illicit states of the TS,
- Maintain of the working condition Analyzing the state of the TS according to a scheduled program and taking the actions to reduce the probability of the failure,
- Preventive examinations - periodic testing of the TS, microclimate, vibration, noise, etc.

For the application of the technical diagnostics there are basically two forms available: a) on-line diagnosis (diagnostic devices are built into the machine, an estimation of the state of the key parts is performed in the run time and it is based on the measured parameters); b) off-line diagnosis (diagnostic measures are implemented after some time the system was in working state, a machine may be excluded from the process of the work.

### **FMEA - FAILURE MODES AND EFFECTS ANALYSIS**

FMEA (Failure Modes and Effects Analysis) is a procedure for analysis of potential failure in the system and their impact on the system and focuses on the prevention and reduction opportunities that cancellation occurs. It is used to detect and prevent problems in the process before they arise. FMEA method involves a disciplined and detailed analysis of the processes and the systems (system, subsystem, assembly or component). For the final assessment of the risks of the potential damages it is necessary to estimate the probability that they will occur. Basic terms used in the FMEA are:

- Failure of the system (subsystems, assemblies or components) – inability of the system to perform the function,
- Form of the system failure - form or the condition of the element after the failure,
- The cause of the system failure - a process or mechanism responsible for the initiation and failure,
- Effect of the system failure - a consequence of the failure to function or system status.



The basic concept of the FMEA method involves decomposition of the system into its constituent elements, to a level that is estimated to be significant in the analysis. FMEA method is implemented in to the worksheets that can take many forms and elements, depending on the system being analyzed and the purpose of the analysis. The final FMEA method is to determine the RPN - Risk Priority Number:

- Assess severity (Severity - S) of each of the potential impact of the cancellation,
- To assess the probability of occurrence (Occurrence - A) Effect of the cancellation,
- To assess the probability of detection (Detection - D) effect of each failure.

RPN is obtained as the product  $S \times O \times D$ , where S, O and D rated value for a particular job.

## **LUBRICATION MANAGEMENT**

Appliance of the Information technology (IT) in the maintenance / lubrication in order to improve the performance of the TS has become a necessity. Lubrication engineers analysis equipment, its components and guidance to reach the recommended lubricant. After collecting and processing the data of the TS, the lubrication points and lubricant, the main tasks are development plans of lubrication and preventive screenings. In order to achieve the effective lubrication plans it is necessary to create the conditions for organized planning lubrication to grow into the management with computer support. Lubrication Management is based on the planning and implementation of plans of the lubrication. Monitoring the state parameters can be carried out continuously or periodically, and for each parameter condition it is necessary to determine a value of a cancellation. In this way it is achieved a preventive lubrication that meets most practical situations and types of technical systems [8]. However, lubrication management is a much broader process. It includes activities:

- Forecasting and prediction,
- Planning,
- Carrying out and coordinating the actions of a lubrication,
- Control deadlines and quality of execution of actions lubrication,
- Control the actual system performance and
- Control of the cost of a lubrication.

Planning is a key function of a lubrication management. Lubrication plan must comply with the maintenance schedule / production.

## **LMSOFT - STRUCTURE AND FUNCTION**

### **Customer requirements**

Software Package Management lubrication should provide, at a minimum:

- Entering, deleting and editing the data about technical systems, lubricants and lubrication points
- Integrated view of the relevant data sets,
- Selection of a different search options for the database,
- Extend the database with new tables,
- Adaptation of the existing search options,
- Creation of a new types of searches and masks to show their results,
- Distribution of the data,
- Creation of a different reports (documents),
- Protection of the data from unauthorized access and incorrect entry and
- Ease of training and use of the program.

## Database

The main goal of a database design is to provide quick and full access to all of the technical systems, lubricants and lubrication points and to provide a support in the management of lubrication using a computer. One of the most important tasks of the preventive maintenance is lubrication, which requires the study of the technical documentation, equipment and instructions for lubricating and finally selection of appropriate lubricants. Database for lubrication management include tables correspond key entities, such as lubricants, technical systems of lubrication, specifications, classifications, quality levels, lubrication maps, orders. These tables, together with tables containing systematized results of FMEA method applied to the infrastructure to be maintained (machines, production lines, transport sredstva, equipment, ...) are the basic structure of the database maintenance scheme. The database represent an abstract model of the real system [9].

## THE PRESENTATION SOFTWARE

**The main form** – Communication between users and the application is realized through a set of a different forms. In that set we can distinguish a subsets of a forms that are characterized by a similar use: forms of presentation of search results, entry forms, delete and edit data forms, as well as a smaller number of forms to navigate additional choices and a variety of informational and warning messages. Starting from the main form (Fig. 1), we will present the structure and functionality of the software package LMSOFT. The main form allows the passage to the basic software functions that cover the user requirements. The main menu contains nine fields / buttons by which we come to associate the form described below. The tenth button closes the program.



Figure 1. The main form LMSOft

**Form of the technical systems** - provides evidence of the TS with all relevant attributes such as: Name, Type, Brand, Manufacturer, Lubrication points, Owner. The TS evidence means filling the basic information about TS to their records in to the database. This data, later, can be used in the operational work. Using this form you can enter information about the technical system, view and / or edit existing ones, delete and add new information about TS and conduct searches. In the subform the selection of lubrication points can be selected for a specific TS (Fig.2).

**Form Lubricants** - It is obvious that the choice of lubricant is one of the main input into the drafting process of lubrication. To ensure that this step in the process of lubricating is done correctly and efficiently it is necessary to ensure:

- Fast access to data on lubricants,
- Display of all important data on lubricants for lubrication TS and
- Selection of appropriate lubricants for lubrication points of each TS.

Information about lubricants are primarily related to the classification of quality levels, specifications, standards, and other attributes relevant to the lubrication process. (Fig. 3).

Figure 2. Form input / review TS

Figure 3. Form input / review of lubricants

**Ticket lubrication form** - From the main menu, you enter into a form called Map of lubrication, where, depending on the type of a technical system, selects lubricant and its gradation for each place of lubrication. On this form are available basic data on the TS: name, group, manufacturer, model, manufacturer's number, year of manufacture, operation, pictures, of lubrication.

Lubrication operation includes records about lubrication, lubricants quantity, working hours (kilometers traveled) and the comments. Form has an option for a quick overview of expenditure of lubricant for each TS and all of lubrication.

**Work Order field** - Lubrication Engineer develops a plan of lubrication (lubrication routes) that are executed in the future. Lubrication plan is executed through the Order of lubrication, which has more options (open, in operation, closed). Form contains a button to view your account.

**Report field** - There are several types of reports relating to the consumption of lubricants and lubrication points by selecting the four time periods (random, monthly, yearly and overall). The available and the list of activities lubrication list by TS drives, sectors, facilities and places where lubrication is observed increased consumption of lubricants.

Form includes fields for diagnostics: analysis / test lubricants, limitations of the analyzes, the analysis of lubrication points, restrictions on service conditions and typical values for field analysis (declared by the lubricant manufacturer - catalog value).

**Catalog of lubricants** - Any factory that produces lubricants has a catalog of their products, which describes in a detail the composition, application and other important properties of lubricants. The key advantage of electronic catalogs is reflected in the speed and capabilities of different criteria and procedures for the database search.

## CONCLUSION

Technical diagnostics and lubrication are key processes of maintenance system, regardless of the adopted concept and technology maintenance. On the other hand, the results of periodic control lubricants used in TS, with established critical limits for individual characteristics are important elements of technical diagnostics. Contemporary concepts of maintenance include proactive maintenance computer aided classified in the production function. Maintenance costs are thus treated as production costs, so the cost of lubrication is directly involved in the pricing of products. We come to the simple conclusion that the use of the software package LMSOFT directly affect the price of the product. Software support for a process lubrication maintenance management represent a module of a IS, which is opened to connect with the environment, such as a software for the laboratory analysis, software for the warehouse management, etc.

## REFERENCES

- [1] ZELENOVIĆ, D. 1995. Tehnologija organizacije industrijskih sistema – preduzeća, IP „Naučna knjiga“, Beograd.
- [2] ADAMOVIĆ, Ž., AŠONJA, A., MILOŠEVIĆ, D., PAUNJORIĆ, P. 2011. Teledijagnostika mašina, Duga knjiga, Sremski Karlovci.
- [3] DESNICA, E., LETIC, D., GLIGIRIC, R., NAVALUSIC, S. 2012. Implementation of Information Technologies in Higher technical education, Journal Metalurgia international, 17(3), pp.76-82.
- [4] ASONJA, A., MIKIC, D., STOJANOVIC, B., GLIGORIC, R., SAVIN, L., TOMIC, M., 2013. Examination of Motor-Oils in Exploitation at Agricultural Tractors in Process of Basic Treatment of Plot, Journal of the Balkan Tribological Association, 19(2), pp.230-238.
- [5] AŠONJA, A., ADAMOVIĆ, Ž., GLIGORIĆ, R., MIKIĆ, D. 2012. Razvoj modela laboratorijskog stola za ispitivanje pouzdanosti poljoprivrednih kardanskih vratila, Tehnička dijagnostika, 11(3), pp.27-32.
- [6] MCDERMONT, R, E., MIKULAK, R, J., BEAUREGARD, M, R. 2008. The Basics of FMEA, CRC Press.
- [7] ASONJA, A., ADAMOVIC, Z., JEVTIC N. 2013. Analysis of Reliability of Carda Shafts Based on Condition Diagnostics of Bearing Assembly in Cardan Joints, Journal Metalurgia International, 18(4), pp.216-221.
- [8] KRUNIC, V., AŠONJA, A., BERAK, J., BABOVIĆ, J. 2012. Economy, Universality and Flexibility of Automatic Filler "NIVELA 12JC", ARPN Journal of Science and Technology, 2(7), pp.567-572.
- [9] KRUNIC, V. 2013. Informacioni sistemi i menadžment kvalitetom – model integracije, Srpski akademski centar, Novi Sad.

## MAINTENANCE SYSTEMS OF ALTERNATIVE ENERGY SOURCES

Miodrag Bulatović

Faculty of Mechanical Engineering, University of Montenegro, Montenegro

e-mail: [bulatovm@ac.me](mailto:bulatovm@ac.me)

**Abstract:** Maintenance systems of alternative energy sources are subject to all the laws of maintenance, any more or less complex, technical systems. For larger wind farms and solar power plants is typical to perform remote management from the dispatch center, which also applies to the operation monitoring and maintenance. In such circumstances, maintaining focus on the strategy, which includes: basic maintenance by the operator, preventive periodic reviews, technical diagnostics, find and eliminate weak points, preventative parts replacement, periodic preventive repair, repair and restoration of other parts.

**Keywords:** hybrid power systems, solar energy, wind energy, maintenance.

### INTRODUCTION - RENEWABLE ENERGY SOURCES

Renewable energy can be divided into several groups: solar energy, wind energy, water courses, biomass energy, geothermal energy, hydrogen energy, energy of environment.

#### Solar energy

Due to the continuous increase in the price of energy, the popularity of solar energy is increasingly growing.

Since the lifetime of the solar system more than 20 years, is evident effectiveness of initial investment in the installation of the solar system, not only financially, but also in environmental terms

The goal of thermal solar collectors is as follows: water heating (Fig. 1), heating swimming pools, heating water in the heating system - radiators, air conditioning space.



**Figure 1.** The use of solar collectors for heating and hot water

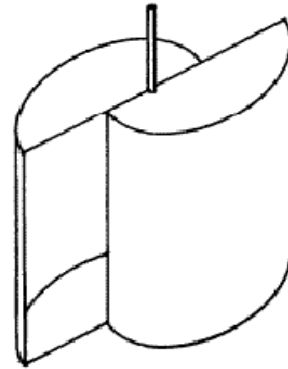
1.Circulator pump, 2. Safety valve, 3. Expansion vessel, 4.Termometer, 5. Drain cock, 6. Automatic air vent valve, 7. Check valve, 8. Room thermometer, 9. Electric heater, 10.Sanitary heat, 11. Solar collector with brackets, 12. Solar Automation, 13. Hot water tank, 14. Valve with electric motor, 15.Radiator.

#### Wind turbines

Wind turbines are a type of plants that use wind energy, which is a renewable source of energy wind turbines consist of support structures in the form of pillars, wind turbines, power generators, the part that regulates the speed of rotation of the generator and the voltage output of wind turbines and ports on a system for accumulation of energy or the power grid.



**Figure 2.** Wind turbines With horizontal axis



**Figure 3.** Wind turbines with vertical axis

#### ***Wind turbines with horizontal axis***

Benefits of wind turbines with horizontal axis (Fig. 2): placed at higher altitudes with higher wind speeds, the possibility of changing the angle of attack propeller (increases efficiency and facilitates speed control)

Disadvantages of wind turbines with horizontal axis: expensive towers taller, vibration during operation, the need for ongoing guidance to the wind axis, the complexity of the design, expensive to maintain high towers and generator assembly at high altitude.

Today, the most common type of wind turbines for high power is exactly the horizontal axe.

#### ***Wind turbines with vertical axis***

A common feature of the construction of wind turbines is that the axis of rotation of the propeller or turbine vertical (Fig. 3).

Advantages of wind turbines with vertical axis are: easy to produce, high torque, durability, most without the need to move in the direction of the wind, unnecessary mechanism for this purpose, it is easier to maintain than horizontal axis wind power as a generator close to the ground itself instituted in any wind direction.

Disadvantages of wind turbines with vertical axis are: lower efficiency of wind turbines with horizontal axis, to produce electricity, a higher degree of mechanical transmission required due to the lower rotational speed than wind turbines with horizontal axis.

#### **Geothermal energy**

Geothermal energy can be in their forms into: energy hot water (natural springs, wells), energy, money, using energy from hot rocks deep below the surface via insertion and heating of cold water. The main advantage of this energy source is its cheapness, stability and durability of the source

Regardless of whether the heat from the earth, the air and water heat pump is the perfect solution for using this type of energy. Depending on site conditions, the type of soil and climatic conditions of the location, will select the most appropriate source of heat, and thus the type of pump (collectors, in-depth probe, air, ground water).

#### **Biomass energy**

Renewable energy biomass and waste includes agriculture with the food industry, the timber industry, forestry, waste and waste water.

From biomass and waste products are electricity and heat, including motor fuel (biodiesel).

Under biodegradable municipal waste is any waste suitable for degradation (food scraps, garden waste, paper, cardboard, ...).

Waste treatment can be: biological - composting, thermal - incineration, mechanical-biological, including size reduction, classification, useful parts, stabilization and homogenization of the residual components and physic-chemical treatment of concentration, neutralization or reduction of harmful ingredients

## Hybrid systems

Hybrid systems are mainly used to generate electricity for more choices

Hybrid systems that are not related to renewable energy use in buildings which require the existence of electricity regardless of the state of the network (hospitals, special facilities, military facilities, banks, etc..).

In such facilities in addition to classic mains or battery packs there.

Hybrid solutions provide increased security and availability of electricity supply and allow smaller capacity battery as the power source (Fig. 4).

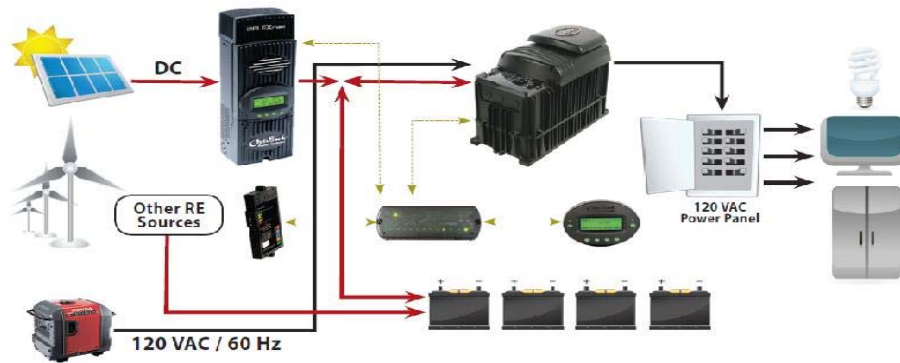


Figure 4. A hybrid battery power

## MAINTENANCE OF ENERGY SYSTEMS

Maintenance of energy systems alternative energy sources is subject to all the laws of any maintenance, more or less complex, technical system.

When designing the system maintenance of energy systems alternative energy sources should be taken that these are mostly automated process unattended, or a system that is periodically under the supervision of the appropriate professional staff is.

The main task of maintenance activities is to prevent and eliminate all types of clients.

Maintenance work are relationship skills and equipment on maintenance to achieve the basic objective function works (inspection, cleaning and lubrication, diagnostics, identification and elimination of weak points, current and planned maintenance, check-ups) and ancillary works (jobs in workshops and laboratories, monitoring conditions, ordering and storage of spare parts and materials, internal and external transport).

On the failure intensity curve shows the area of life means work (Fig. 5) shows that the impact of subsequent strategies and preventive maintenance.

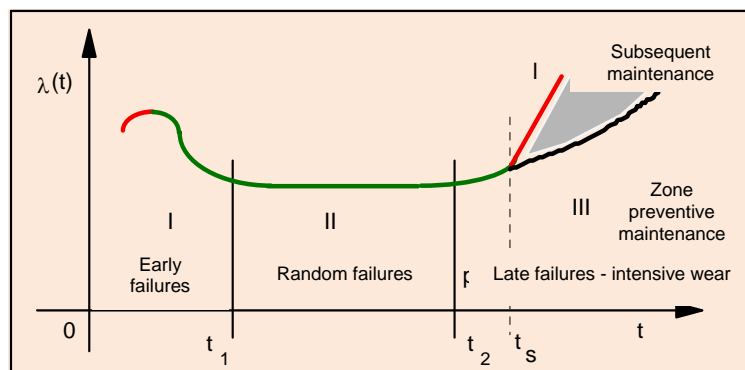
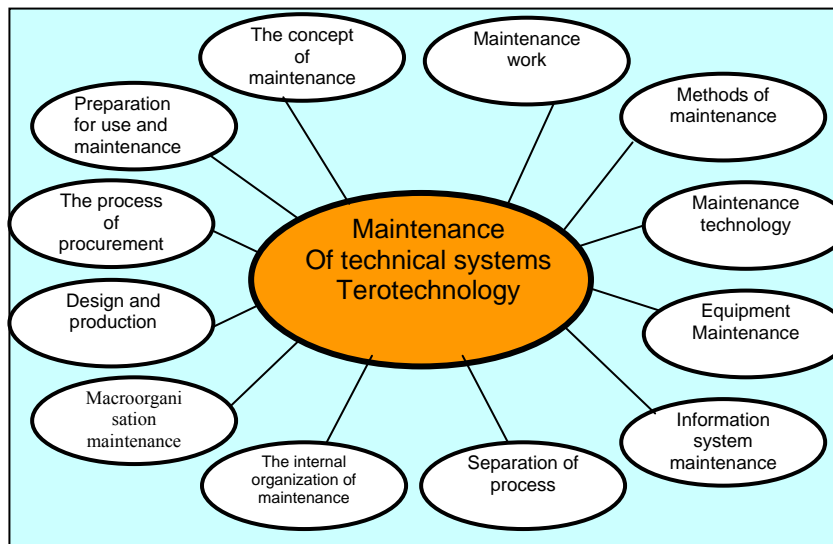


Figure 5. Density function of the states of failure and system failure intensity (curve "bathtub").

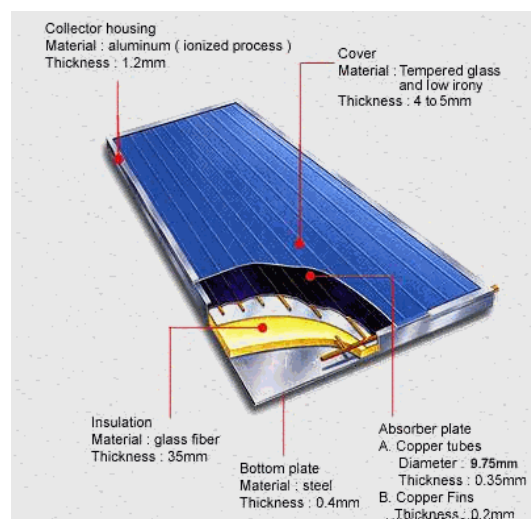
Terotechnology maintenance concept includes a rounded approach to maintenance functions, which starts system design or bows and equipment as well as parts of the system and ends up separating from the commercial operation (Fig. 6).



**Figure.6** Terotechnology approach to maintaining the technical system.

### Maintenance of solar systems

Solar systems with quality Arbitration and installed solar equipment (Fig. 7) generally do not require frequent and costly maintenance. Maintenance of solar collectors involves basically preventative maintenance procedures.



**Figure 7.** Flat panel collector

Basic maintenance (permanent technical supervision) includes those procedures that are generally performed to the fullest extent, I operator (or user) technical system, without any special tools and devices.

Maintenance procedures to be conducted at a higher level (technical diagnostics, repair, etc.), on-site and in workshops with the participation of specialized workers are often unable to compensate for gaps in basic maintenance.

It should be controlled if the glass is damaged or dirty.

It is clean as needed, with a wash early in the morning while collectors are not yet warmed up to avoid spraying glass.

At least twice a year, after the summer and winter, thoroughly review the glass

All loose connections must be tightened.

Causes of the weak points of the solar collector can be structurally weak solution (weak isolation, the emergence of higher temperatures than predicted, etc.). Also causes of weak points can be found in poor operation and maintenance of solar panels.



Preventive replacements collectors are performed to maintain operation and reliability of the system to the required level.

During the audit paid particular attention to the connection between the collector and the collector pipes.

If you work provides collectors in winter then later in october to replace the water with antifreeze.

When replacing the glass panels, after removing the frame should be cleaned from all surfaces of permanent whale and at the same time be careful not to damage the surface of the absorber.

It is necessary to examine internal structures (absorber, connections, insulation, etc.) and damaged parts replaced.

If there is no special manufacturer's instructions, corrosion perform one of the classic ways.

### Maintenance of wind turbines with horizontal axis

Parts of a typical horizontal axis wind (Fig 8) are: The supporting structure in the form of pillars, Wind turbine (propeller), Mechanical transmission, which boosts the low speed rotation of the blades to a propeller, required for generator, Generator power, The part that regulates the speed of rotation of the generator and the output voltage, Connection to the system of accumulation of energy or the power supply.

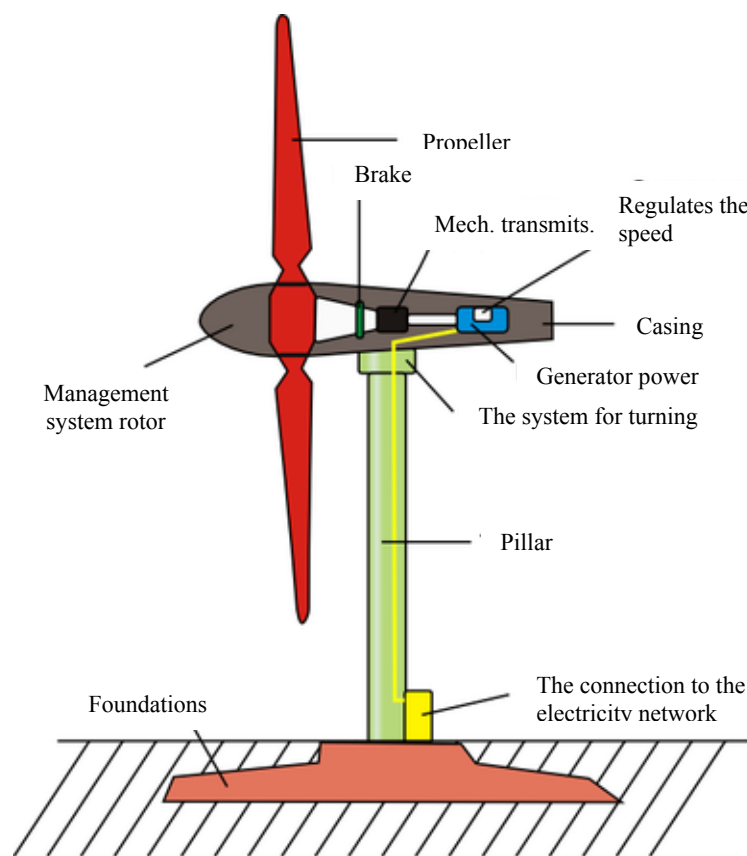


Figure 8. The basic construction of wind turbines

Management is done remotely from the dispatch center, and oversight of the wind turbine manufacturer usually does - also from a remote center.

The wind turbine possible: no big operation and maintenance once the repayment of capital investment for the free and low-cost fuel generated electricity.

Maintenance of the wind turbines is an important part of the total cost of the turbine up to 25% of 1 kWh over the life of the turbine. Therefore, manufacturers are trying to reduce the maintenance costs of new turbine designs that will require fewer services and turbine failure

Operating costs of wind turbines include: Insurance (13%), regular maintenance, repairs, spare parts (26%), Land rent (18%), and legal fees (5%), Administration (21%) and other (17%).

Maintenance work wind turbines include:

- inspection, cleaning and lubrication (periodic oil changes gear, cleaning turbine blades, tightening screw propeller turbine)
- preventive maintenance activities based monitoring system using the methods of technical diagnostics
- Medium and large repairs to replacement of certain parts of the circuit.

Recommendations of the architect is to be planned inspections, cleaning and oiling done twice a year for 12 to 18 hours of work breaks wind turbines.

One of the main tasks of the designer to master a large propeller torque, which is transmitted to the gear unit.

One way to decrease load torque of the gear was broadcast on more generators, thus not only have reduced clients gear but with more generators provided greater readiness (availability) of wind turbines as a system, as well as simpler repair small generators.

It is very important comfort to workers in terms of maintaining office space and easy access circuits.

The goal is the availability of the equipment inside the tower, thereby increasing the safety of workers and the quality of the work.

## CONCLUSIONS

Efficiency of systems of alternative energy sources in the highest percentage depends on the efficiency of maintenance.

Maintenance systems of alternative energy sources is carried out on all assumptions of modern maintenance principles.

Maintenance systems of alternative energy sources requires a high degree of automation of maintenance or higher level of sophistication.

## REFERENCE

- [1] Bulatović, M. ODRŽAVANJE HIBRIDNIH ENERGETSKIH SISTEMA, Savjetovanje "Hibridni sistemi obnovljivih izvora energije" Inženjerska Komora Crne Gore, Podgorica, Maj 2011.
- [2] G. Toomey, V. Koković, A. Stijepić, MAINTENANCE STRATEGY CONTINUOUS IMPROVEMENT VITAL TO YOUR LONG TERM SUCCESS, SKF Condition Monitoring Center, 5271 Viewridge Court, San Diego, CA 92132, USA
- [3] Radovanović, Lj., Adamović, Ž., Pekez, J. MAINTENANCE OF SOLAR COLLECTORS, Zrenjanin.
- [4] Radaković, Z., Paunović, N., Mitev, I., OPTIMALNO PROJEKTOVANJE HIBRIDNOG SISTEMA ZA OFF-GRID NAPAJANJE ELEKTRIČNOM ENERGIJOM, Telekomunikacioni forum TELFOR 2009 Srbija, Beograd, novembar 24.-26., 2009
- [5] Keshav P, Dahal, Nopasit Chakpitak, GENERATOR MAINTENENCE SCHEDULING IN POWER SYSTEMS USING METAHEURIDTIC-BASED HYBRID APPROACHES, University of Bradford, UK, 2006.

## APPLICATION OF THERMOGRAPHY IN MAINTENANCE SYSTEM

Slavica Prvulović<sup>1</sup>, Ljubiša Josimović<sup>2</sup>, Dragiša Tolmač<sup>1</sup>, Rade Hrnjak<sup>1</sup>

<sup>1</sup>University of Novi Sad, Technical Faculty "Mihajlo Pupin", Zrenjanin, Serbia

<sup>2</sup>Textile High School of Professional Studies, Leskovac, Serbia

e-mail: prvulovicstavica@yahoo.com

**Abstract** : Application of thermography as a method of technical diagnostics within the computer-integrated maintenance together with the formation of adequate data base represents a modern approach to maintenance and creates prerequisite for reliable and efficient work. This paper presents results of a research on concrete examples of computer-integrated system of maintenance in machine manufacturing plant. The subject of this analysis were thermal image footages of a few units which are frequently used and where the application of thermography as a technical diagnostics was very useful. The application of thermography method on machines' supply circuits, transmission mechanisms, operating elements, and also performance of tools on machine and thermographic examination of power distribution boxes was considered. Application of thermography method with computer-integrated maintenance system enables diagnostics of potential outage, shortening of period of outage, increase of efficiency and productivity.

**Key words:** Thermography, maintenance, machines, diagnostics.

### INTRODUCTION

Application of thermography method, the preventive method of technical diagnostics enables contactless, fast and efficient way of revealing problems in operation of certain machines. That is the method which is applied while the machines operate and it enables discovery of potential cause of failure, outage of machines. Thermography method enables diagnostics of excessive heating, overheating and outing which can manifest in increase of temperature of certain assembly on a machine [4].

Thermography can be defined as a technique which registers infra red rays which is characteristic of every object whose temperature is above the absolute zero. Thermography is not a pure temperature registering, it is a technique which uses a sophisticated equipment and diagnostic software for state of objects based on their infra red radiation [2, 6]. IR (infrared) thermography is a contactless method of temperature measuring and spreading over the object. It is based on the measuring the intensity of infra red rays from the observed object. The result of thermography measuring is a thermogram which in grey tones or some code of colours reflects temperature spread on the surface of the observed object [7, 8]. The temperature spread, indirectly gives information about different states of the surface itself or it reflects the structure and internal state of the object observed.

In the simplest version, thermography system consists of thermographic camera and the unit for processing thermograms (personal computers). There is IR optics, IR radiation sensor, unit for transforming electric into video signal, monitor and a card for collecting data integrated inside the card. The computer serves to process thermograms using a certain software which reads the data from the card inside the camera [1]. Since the characteristics of electromagnetic rays are equal for the entire electromagnetic spectra, it is the optics used in the IR devices, although it uses different materials from which it is made, the design is the same as in photographic devices.

Materials used to make lenses have to be permeable for IR radiation, those are: germanium, zinc sulfide, zinc selenide for low-frequency IR radiation, and silica, sapphire, quartz or magnesium for medium-frequency IR radiation.

In order to calculate the correct temperature of the observed object from the rays on the camera it is necessary to know the characteristics of the surface of the object, temperature of the surrounding objects, the distance of the camera from the observed object, temperature and relative humidity of the air [3]. It is necessary to adjust these parameters as entering parameters in the camera software. The effect of radiation from the environment have to be minimal, especially if the object observed has the temperature similar to the surrounding objects or it has a low emission factor.

## MATERIAL AND METHODS

### Application of thermography in production engineering

Method of thermography diagnostics in technical maintenance in production engineering can be used for examination of thermal characteristics in following fields:

- Examination of supply circuits of machines
- Examination of transmission mechanisms of machines
- Examination of operating elements of machines
- Examination of tools on a running machine
- Examination of industrial furnaces
- Examination of power distribution boxes
- Examination of climate in workspace

It happens a lot for a failure of machine to occur unexpectedly, and that stops the activity. The main reason for that is the higher level of noise in workspace than in other workspaces, caused by operating machines and ventilation and due to noise made by processing materials by milling, scraping, etc. in such conditions it is hard to notice a change in the sound a machine makes unless it stops working or it signalizes a failure.

By examining transmission mechanisms of machines one can check the quality of lubrication of transmission mechanisms of machines, on circuits available for his type of control. The main goal of lubrication of transmission mechanisms of machines is reduction of resistance during operation, i.e. less wear of materials due to moving and touching of work surface, this is mainly applicable to axle, gear, bearings, gear lath, lever, etc. [5]

When the machine stops or it is poorly lubricated, the friction is greater and it leads to damage of mechanism and machine failure. Before the failure, the temperature rises, and the worker on the machine can not notice it while working, but the occasional thermography control can.

Frequent cause of termination is the failure of control/power unit, i.e. supply circuits of a machine. That mostly happens due to failure of electronics or relay switch inside the control/power unit.

Electronics inside the control/power unit serves to constantly control the working parameters of a machine (speed, direction of work, head position, tools' position, selection of tools, etc.) and it happens that certain elements on printed circuit board overheat. This happens, for example due to poor cooling if the electronics cooler has stopped working or the filter fan is dirty so the air flow through the cooler is reduced.

Failure of relay switch/set inside the control/power unit happens due to voltage drop on relay contact. With the increase of power flow and frequent use of the contacts, the surfaces are damaged and the voltage drop occurs. The voltage drop causes heating of the housing of relay and the printed circuit board and the contact on the board gradually drops.

By using thermography one can notice the overheating of printed circuit boards, coolers or relay contacts on time.

Thermographic examination of working elements of a machine means temperature control of ventilation elements of a machine, temperature control of the machine engine as well as upgrade kits which contain separate power supply [2, 6].

Noticing the overheating of ventilation engine which can be caused by poor air flow in the ventilation system or the machine engine can prevent a major breakdown.

Examination of tools on a running machine by thermography can be used for a quick quality check and the degree of sharpness of tools. A piece of tool which is dull or badly sharpened will heat more and that heating is transmitted to processed materials. More energy for materials processing is used, and the processing is imprecise and the material itself can change its shape due to heating.

Thermography examination of industrial furnaces is the ideal way to examine tightness of furnaces, ventilation system and to check the security level for the operator.

Industrial furnaces due to their dimensions, high working temperature and frequent use, demand special fire protection standards and special training. Periodic application of thermography inspection can provide on time noticing of disadvantages or security omission in work.

Examination of power distribution boxes by thermography method provides quick check of compounds, switches, circuits. The breakdown of a machine often happens due to power failure. Since the processing machines are huge electricity consumers, they demand quality and reliable installation. In the machine processing units, the electric installation is done under special technical conditions and it is dimensioned for work in such conditions. This includes a separate power distribution box for that unit, special power box for each machine and security power supply for the machine (through ceiling to the machine through a metal pipe).

Apart from strict normative for electro-power installation in machine units, the breakdown occurs due to fuse burning, switch burning, poor contacts on serial terminals in power distribution boxes and breakdowns of on/off machine switches. This is the result of damage of contact material which causes overheating which then leads to deformity of contact material carrier and finally leads to power cut.

Since each anomaly in power system at first manifests itself by increased local heating, occasional thermography inspection of power distribution boxes can prevent breakdown due to power loss. Also, this can prevent a fire due to malfunctioning of power installation, which is often a case in industry.

Examination of climate in workspace by thermography method includes workspace temperature check, ventilation system check, air-conditioning check, heating check, possible leaking check, possible flood check, etc. during operation, machines release lots of energy and it is often the case that temperature around machines is high and if ventilation or air-conditioning is poor, the operator faces difficult work conditions which increases chances of injury, reduces efficiency and productivity and has a bad influence on the entire work atmosphere.

Thermography check of ventilation and air-conditioning, i.e. check of canals for ventilation, filters, engines and compressor can reveal cause of poor production and overheating. For example, obturation of the air-conditioning channel manifests itself in higher temperature in the channel, a filthy filter does not have the satisfactory air flow through the ventilation/air-conditioning system and it results in higher temperature in the workspace. Heating system is easy to check by thermography because the temperature differences are easy noticeable on heating units, it is easy to measure temperature of individual heating units and to detect potential failures.

In machine processing drives, a great amount of daylight is needed, and it is provided by big roof skylights on flat or hip roofs. This can be a weak link of the object where leaking can occur due to rain or snow melting. Thermography control allows easy spotting of such places.

Potential breakdown spots on plumbing in the drive (plumbing valves, taps, reservoir, etc.) can be recognized by thermography inspection and prevented.

### Thermography examination of transmission mechanisms of machines

Figure 2 shows normal maximum temperature which is 37,0 °C which shows that lubrication is correct and that oil pump distributes oil correctly through the machine.

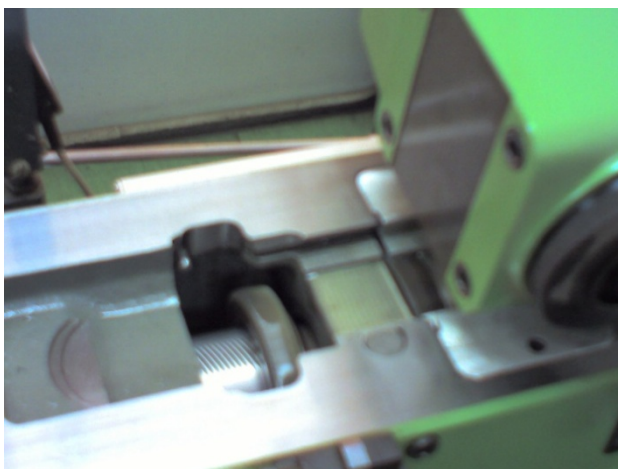


Figure 1. Pinion shaft milling Deckel

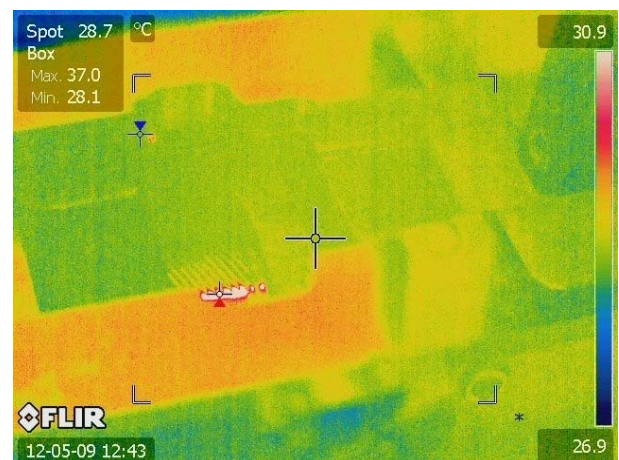


Figure 2. Thermography examination of pinion shaft milling Deckel

### Thermography examination of industrial furnace



**Figure 3.** Industrial furnace – door



**Figure 4.** Thermography examination of the door of industrial furnace

Figure 4 shows maximum temperature which is 60,4 °C on the compound of the door and the furnace itself. Since the temperature inside the chamber furnace 150 °C, we can say that the tightness of the door is satisfactory, but that more frequent control and higher prudence of the operator is necessary.



**Figure 5.** Industrial furnace-ventilation system



**Figure 6.** Thermography examination of ventilation system of industrial furnace

Figure 6 shows maximum temperature of 75,3 °C on the ventilation system of industrial furnace. Release of heat on the compounds is noticeable. Temperature inside the ventilation pipe is 150 °C.

## RESULTS AND DISCUSSION

### Thermography examination information processing

As a result of thermography examination we get two photographs for each examination. One of them is in visible part of spectre taken by a classic video camera which is integrated in the common housing with thermography camera, and the other photograph in the infra red part of spectre taken by thermography camera.

On thermography photography, depending on camera settings, there are data about the time the shot was taken, the temperature in the centre, maximum and minimum temperature with arrows showing the position of maximum and minimum temperature.

Depending on camera adjustment, temperature distribution can be shown as grey shades or in colour. When colours are used, white and red represent maximum temperature while blue and black represent minimum temperature. There is colour legend on the right part of photography.

Photographies can be viewed on the screen on thermography camera and analyzed on the spot, and it is possible to download the photographs on computer.

One way to process and analyze photographs is the application of a program called "THERMACAM QUICK REPORT" manufactured by Flir. This program arrives with the camera and it possesses all the necessary functions for processing and archiving the photographs.

Connecting the camera to the computer with the installed program initiates the guide for transferring the pictures. Inside the window of the program one can format the photography base, analyze photographs and create examination reports.

## CONCLUSION

As a practical part of research on a real example of computer integrated maintenance system in machine processed drive, thermography shots were analyzed and it proved to be useful. Method of thermography examination of machines within the computer integrated maintenance system is applicable and economically justified. Periodic thermography examination of machines and creating data base within the computer-integrated maintenance system is the approach which increases efficiency and reliability. Method of thermography examination demands special training and constant professional training along with monitoring of production problems.

Application of thermography method of examination within maintenance is financially justified method if it is used inside the planned programme for technical maintenance. Since it is contactless method which is used while the machines are operating, it does not disturb the production process. Inside the computer-integrated maintenance system, application of thermography has its place as one way to collect data about the equipment which is the target of maintenance.

## REFERENCES

- [1] Antić, D., Stević, Z., Rajčić-Vujasinović, M., Thermal imaging system for monitoring industrial and power plants operated personal computer, *Inovacije i razvoj*, no. 1, pp. 65-77, 2007.
- [2] Čičkarić, Lj., Application of thermography in the diagnosis of thermal condition of power transformers, *Proceedings of the Electrical Engineering Institute "Nikola Tesla"*, no. 19, pp. 249-260, 2008-2009.
- [3] Kostić, M., Vujčić, Lj., Indicators periodic thermographic recording shell boiler TE 54 in 'Energetics Sartid' ad in Smederevo, *Procesna tehnika*, vol. 18, no. 1, pp. 270-272, 2002.
- [4] [Prvulović, S.](#), [Josimović, Lj.](#), [Savić, N.](#), The Implementation of Remote Maintenance of Bucket Wheel Excavator (Article), *METALURGIJA INTERNATIONAL*, (2013), vol. 18 br. 1, str. 59-62 ISSN 1310-4772)
- [5] Prvulović, S., Matić, M., Tolmač, D., Uloga održavanja u upravljanju životnim ciklusom proizvoda, *TEHNIKA – MAŠINSTVO* 59 (2012) 4, str.578-585, SMEITS, Beograd, (YU ISSN 0040-2176), (YU ISSN 0461-2531) UDC:62.(062.2)(497.1)
- [6] Sencanić, M., Čickarić, Lj., Application of thermovision tests in the Preventive Maintenance of Transformers, *Proceedings of the third international power systems conference, TIMISOARA*, november 18-20, vol. II, pp. 72-77, 1999.
- [7] Senčanić, M., Čičkarić, Lj., Application of thermographic inspection in monitoring of electric and thermal power plant equipment, *Elektroprivreda*, no. 1, pp. 43-48, 2000.
- [8] Senčanić, M., Čičkarić, Lj., Simić, N., Vukelja, P., Overview of results of thermal control in plants Elektroistok during the period 1997-2002, *Proceedings of the Electrical Engineering Institute "Nikola Tesla"*, no. 15, p. 25-32, 2003.

## PYROLYSIS FURNACE TUBE DAMAGING AND INSPECTION

Ištvan Kucora<sup>1</sup>, Ljiljana Radovanović<sup>2</sup>

<sup>1</sup>Stock Company for Production of Petrochemicals, Raw Materials and Chemicals „HIP-Petrohemija“ Pancevo - under Restructuring, Pancevo, Serbia

<sup>2</sup>University of NoviSad, Technical faculty „Mihajlo Pupin“, Zrenjanin, Serbia

email: [kucoraistvan@gmail.com](mailto:kucoraistvan@gmail.com)

**Abstract:** This paper explain the most occurring failure mechanisms for pyrolysis furnace radiant tubes. Basic damaging mechanism is the combined action of carburization and creep ductility exhaustion. This results in bulging, bending and ovalization of the tubes. The second dominant failure mechanism is brittle fracture during furnace trips, which can result in large, longitudinal cracks on many tubes. There are several methods for estimating and damage detection of furnace tubes. In assessing the state of furnace tubes we use an optimal combination of methods, as individual methods can not detect any potential damage. The methods are related to the assessment of damage due to creep, and the material carburization which underlying the creep.

**Key words:** pyrolysis furnace, furnace tube, tube inspection.

### INTRODUCTION

Pyrolysis coils in ethylene cracking furnaces (Fig. 1) are exposed to very severe conditions, e. g. high temperatures up to 1150 °C, severe start/stop and decoke cycles, oxidizing and nitriding flue gases at the outside and carburizing atmospheres at the tube inside surface. Therefore, high-alloyed centrifugal cast Ni-Cr-Fe alloys with adequate high temperature corrosion resistance, good high temperature strength, good machinability and weldability (even after years of service) are required.

Radiant coils have a limited life and failure is caused by a variety of factors, many being related to furnace operation. However, each pyrolysis plant experiences specific operational conditions and operational philosophies. Therefore, each plant has typical causes for radiant coil failure and it is of importance for operators to analyze and to understand the typical failure mechanisms. This will enable them to consider the material grades, which would be best suited for those particular conditions and also to keep failures within limits by proper furnace operation. Mechanisms which causing the majority of failures in radiant tubes are: coke formation, creep ductility exhaustion, thermal fatigue, brittle fracture, erosion, overheating, human factor, creeping, carburization, oxidation, nitridation, chromium evaporation. Tube sheets and tube supports should be examined to determine their physical condition and fitness for further service. Supports should be examined carefully for cracks, oxidation, corrosion, distortion and sagging.

There are several methods for assessing and detecting the damage of the furnace tubes. All heater tubes should be inspected, preferably early in life, to establish base-line conditions for tube diameter, wall-thickness, microstructure, and metal hardness.



**Figure 1.** Pyrolysis furnaces in ethylene plant



## FURNACE TUBE FAILURE

Tube failures result from progressive deterioration from a variety of deterioration mechanisms. Therefore, one needs to understand the active and potential mechanisms in a particular pyrolysis furnace in order to prevent them from causing a failure. Tube reliability not only requires an understanding of the mechanisms by which the tubes can fail, but also requires data on how the previous operating history has impacted tube life, predictions of deterioration rate, how the future operation will impact tube life, and finally, monitoring of operation and deterioration to ensure the analyses and predictions are accurate and appropriate. Historically, inspection data gathered during outages assessed the immediate condition of the tubes with varying degrees of accuracy or success.

Creep is the primary cause of the furnace tube damage. It usually initiates within the tube wall some two-thirds of the way through from the outer surface, making it impossible to detect by in situ metallography [2]. This is opposite to boiler super heaters and headers where creep damage initiates at the outside surfaces, making it much easier to detect.

Creep elongation (also called stretching) occurs because of creep by the self-weight of the tube and the coke layer present in the tube and is influenced by temperature, the load carrying cross section of the tube, and the material used. A consequence of a high creep rate is the need to shut down the furnace and to shorten the coils (some end-users have lowered to bottom floor). Failures can occur if tubes are not shortened before they reached the heater floor (Fig. 2). The coils are warped and bowed, resulting in higher tube stresses and creep rates.



**Figure 2.** Pyrolysis furnace radiant zone - consequence of a high creep rate

During service, hard deposits of carbon (coke) build up on the inner wall of the tube, reducing heat transfer and restricting the flow of the hydrocarbon feedstock's. About every 20 to 60 days, the furnace must be taken off-line and "decoked" by burning out the accumulated carbon.

Carburization is the carbon enrichment and carbide formation in the tube material under influence of the presence of carbonaceous gases and high temperatures. This accelerates carbon diffusion in tube material, especially during the decoking period. Carburized material in the inner wall of the radiant tube has a higher thermal expansion coefficient and tends to increase in volume and place stresses on the tube. These thermal stresses make the tube more susceptible to creep failure [5]. The deposition of the coke at high temperature is generally inhibited by the presence of a Cr<sub>2</sub>O<sub>3</sub> layer on the inner surface of the tube. When this film is present carbon diffusion into the tube is retarded. However, during decoking, the tube may be subjected to severe thermal shock that results in removal of the Cr<sub>2</sub>O<sub>3</sub> layer, so the carburization attack increased [8]. Because of exposure of tube at elevated temperature, carbon diffusion could promote formation of continuous and/or separated carbides in grain boundary and matrix [1, 7,8]. These carbides decrease the creep resistance and ductility at high temperature.

Metal dusting is a catastrophic form of carburization that can result in rapid metal wastage in both ferritic and austenitic alloys. This damage mechanism typically has the appearance of localized pitting, or grooving, along the inner walls of pipe and tubes [8].

The ductile failure can be recognized by a bulge on the tube and a short longitudinal crack on top of the bulge. In the micro-structure creep voids can be observed between matrix and carbides[1].

The brittle fracture can be recognized by a long longitudinal crack which “ends” in a fork-like appearance. Sometimes, the cracks result in circumferential rupture or “windows” that fall out of the tube. The cracks can be many meters long, and many times, a thick coke layer is present inside the tube. In the micro-structure can be observed that the carbides have split. This is a marked difference to the ductile fracture and can be recognized easily[9].

Another failure mechanism is overheating, which results in local melting or overall melting of the tubes. Such an overheating can happen due to lack of flow, coke blockage or burner problems (flame impingement). Lack of flow can occur when inlet valves fail or in case of compressor problems.

Above 1100 °C nitriding respectively internal nitride formation occurs from the outer diameter of the radiant tube (flue gas side). Nitrogen penetrates through the oxide and reacts with chromium by precipitation of nitrides. Due to nitriding the rough as-cast surface disappears and the surface becomes a smooth and glazed appearance[4]. The nitrides may cause spallation of the oxides. As a result a thick layer of oxides (up to 10 – 20 cm thick) can be found on the furnace floor. Sometimes, this is called oxide shedding.

Another form of elevated temperature degradation of austenitic stainless steel is sensitization. This caused by precipitation of chromium carbides preferentially at grain boundaries. The immediately adjacent chromium-depleted zone is susceptible to accelerated corrosion in some aqueous corrosives. Sensitization has little or no effect on mechanical properties but can lead severe inter granular corrosion in aggressive aqueous environments such as polythionic acid. Polythionic acid can form during downtime on equipment that has been even mildly corroded by hydrogen sulphide at elevated temperature. The iron sulphide corrosion product combines with air and moisture to form the acid and induces intergranular corrosion and cracking[4].

Erosion can be observed in 90 or 180 bends or in Y-pieces. The most accepted theory is that erosion is caused by hard coke particles during decoking. Some investigators believe that this erosion is caused by coke particles, which are present during normal operation. The remedy is to modify the decoking procedure, so that the coke is gasified instead of being spalled. Second remedy is to lower the gas velocity during decoke below 200 m/s. Third remedy is to apply “internally stepped fittings”, which have been applied successfully on many occasions.

## FURNACE TUBE INSPECTION

Inspecting furnace tube is sometimes not an easy task. Everyone is looking for an inspection method or test equipment that will find cracks or leaks 100% of the time. There are a variety of methods of inspecting or testing furnace tubes. In assessing the state of furnace tubes we use an optimal combination of methods, as individual methods can not detect any potential damage. Test methods which involve the removal of pipe from the furnace is the most expensive as it is necessary to remove the tube from furnace and then remove the pattern.

### Visual inspection

On-stream visual inspection of visible flame patterns can indicate potential areas of concern. An erratic, unbalanced flame may be a sign of damaged swirl vanes, improper air/fuel mixture, coking on the burner tip or leaking tubes. An erratic flame may impinge on nearby tube walls, causing hot spots and areas of potential ruptures.

Structural components, such as tube supports, that are visible from inspection ports should be examined to ensure they are intact. Any external tube suspension systems and pre-load and compensating devices should also be subject to routine inspection.

Tubes should be inspected for bulges, sagging, bowing, localized discoloration or leakage. Hot spots may be the result of flame impingement. Tube misalignment may be caused by damaged supports, or supports that are preventing the thermal growth of the tube.

Refractory should be visually checked for cracking, spalling, erosion, and localized discoloration. Areas of damage should be monitored for high temperatures and identified for repair during the next

planned outage. A visual examination of the external casing should be made to detect any hot spots. Infrared thermography was used to online monitoring of pyrolysis furnaces.

During planned downtime the tube coils should be inspected closely for bulging, bowing, sagging, splitting, scaling, corrosion, and deposits from fuel gas. Fittings may show signs of damage, distortion or corrosion. Internal inspection of tubes is limited to those types which have removable U-bend or plug type fittings. Remote examination may also be utilized, using a boroscope, video camera or other visual aids. Suitable record such as videotapes should be maintained.

### **Tube temperature monitoring**

Tube failures are most commonly due to overheating. Therefore close attention must be paid to on-stream monitoring of tube temperatures. Routine recording of tube temperatures into a permanent record is crucial to enable the remaining safe life of the tubing and suitable inspection intervals to be established. There are two basic systems for tube temperature monitoring: contact tube-skin thermocouple and non-contact pyrometers. They serve a couple purposes. First, the thermocouples can alert to abnormal operation if temperatures dramatically change. Second, they provide a means to calculate and monitor remaining tube creep life. Strategic placement of the thermocouples is necessary so that the entire firebox can be reasonably monitored. Malfunctioning burners or unbalanced firing of burners can create local hot zones in the firebox and lead to premature failures. In addition, tubes that historically operate hot due to their placement in the coil may need a thermocouple, especially if it represents the most severe service of the tubes.

Infrared thermal scanning of tubes helps fill the gaps created with the tube-skin thermocouples. Infrared scanning inspection can determine local tube metal temperatures in the areas not covered by the tube skin thermocouples. Generally, tube rupture occur in very local areas of overheat. Infrared scanning has proven effective in identifying localized "hot spots" before they cause a failure. A periodic scan of heaters is common practice although some heaters whose tubes are particularly prone to coke buildup may require more frequent scanning. Additionally, infrared scanning with non-contact pyrometers provides a means to check the accuracy of tube-skin thermocouples.

### **Thickness measurements**

Ultrasonic thickness readings should be taken at specified locations on tube coils in the radiant section, accessible shock (shield) tubes in the convection sections and return bends. A recent technological advance in furnace tube inspection has seen the development of a multi-module pig which can increase the number of data points from the typical 200-300 to in excess of 300,000. The tool can be used to inspect both the convection and radiant sections. However, since it uses ultrasonic, the inside of the tubes must be cleaned prior to inspection.

### **Tube growth measurements**

Tube coils and return bends should be gauged for bulging or creep growth and the history of tubes that have been replaced due to thermal growth should be kept. Thermal growth may occur when the tubes are subjected to localized short-term overheating, long-term high temperature exposure (creep), or localized thinning of the tube through corrosion or erosion.

The maximum limits of diametrical growth based on acceptable levels of creep must be established and readings checked against these limits. Special pre-set gauges can be used to quickly scan the length of a tube and a micrometer used to take precise measurements at pre-selected locations or areas of concern.

Inspection methods that are based on laser technology in recent years has experienced rapid growth. With the advent of laser measuring profilometry outer / inner diameter of the pipe, as well as elongation, is given a new dimension to overcome the disadvantages of an earlier measurement methods. Ability to accurately measure and record the growth of creep means that the condition of pipes can be measured from the first day.

### **Carburization assessment**

Carburization - is the diffusion of elemental carbon into solid steel in contact with a carboniferous material at high temperature. This results in a brittle material. Austenitic tubes are essentially nonmagnetic. Carburized areas of the tubes become magnetic, and if these areas are large, they can be detected with a magnet. A magnet on a string dropped down a tube will indicate areas that are magnetic but will not indicate the depth of carburization. An eddy current instrument (Hall Effect hand held probe) called a magneto-scope should be used to build up a history of magneto-scope measurements. Any tube that indicates higher magneto-scope readings in any region should be checked by dye penetrant on the O.D. for cracking. Radiography should be carried out on the region to determine the condition of the I.D.

### **Radiography**

Radiography may be used to inspect weldments, tubes, and return bends etc. It will provide evidence of wall thinning, deposits, pitting, cracking and internal obstructions etc. In circular heaters the film can be placed behind each set of tubes or return bends at a given elevation, and the source can be located in the center. One panoramic exposure can then be taken that includes all of the tubes.

When radiographing a tube to determine if corrosion, deposits or coke is present, it is important to remember that these will usually occur on the fire side of the tube, as this is the hottest side of the tube. If a radiograph is taken on a horizontal tube, the film should be placed as close to the horizontal plane as is practical. The resulting film will show the profile of the fire side of the tube wall and the opposite side furthest from the source of heat.

### **Hardness measurements**

Hardness testers -mechanical and electronic hardness testers can be used to determine the hardness of base metal, welds, and heat-affected zones. Electronic testers must be used with extreme care on thin materials or erroneous readings may be obtained. Hardness tests should only be specified only after it has been determined that the base material is suitable; as some materials (i.e. carburized, cast materials) may well be damaged if hardness readings are taken.

Hardness considerably increases with the extent of degradation, compared with virgin material. There is a relation between carburization and hardness, and electrical resistivity and carburization, so the electrical resistivity is inversely proportional to the hardness [6].

### **Metallurgical analysis and mechanical testing**

It may be necessary to remove samples to assess the mechanical and metallurgical integrity of furnace components that are approaching their design life and cannot be assessed in place due to the design (i.e. finned tubes), or when inspection results indicate that sample removal is required to enable the overall condition of the furnace to be verified. Metallurgical considerations for sample removal would include: suspected high temperature creep damage, sensitization, carburization, decarburization, spheroidization, oxidation, embrittlement, etc. The investigation included tensile tests, optical microscopy, scanning electron microscopy (SEM), energy dispersive spectroscopy (EDS), and X-ray diffraction (XRD) analysis.

Scale/deposits- Samples of surface scale and deposits can be analyzed to determine composition, source of contamination and provide an indication of the degree of overheating.

In site metallography- provides metallurgical information to check for material deterioration, creep damage etc., without destroying its function.

Analyses of a pyrolysis furnace tube microstructure show that essential changes in material structure and properties appear during the operation at high temperatures. Uncontrolled carburization process result in coke deposits on tube causing heat stresses. Therefore, but also due to material creep, radial micro-cracks and fracture appear [5]. The fracture propagation is along the grain boundary where carbides are extracted in chains [7]. Initial austenitic structure has changed its characteristic in some

places appearance of delta ferrite formation and sigma phase, which reduce material ductility together with the carbides inside and along the grain boundaries.

### Pressure test

Before the furnace is returned to operation, a pressure test on the tube coils will reveal any leakage not apparent from a visual inspection. All pressure tests should be performed in accordance with a written procedure which includes the safety precautions to be taken, test pressure and temperature, how water will be drained from vertical coils etc. A full temperature compensated hydrostatic test is required when welded repairs to the pressure envelope have been made. When a full hydrostatic test is not practical, a pneumatic test or alternative testing may be conducted.

### CONCLUSION

Process furnaces are critical components in the oil and petrochemical industry, and the process equipment damage assessments have great importance for providing a safe, highly effective and long-term work. Traditional means of monitoring these high temperature vessels have frequently been more art than science, often relying on highly subjective analyses and/or frequently inaccurate thermocouple data. Time interval replacement of tubes is essential in costs reducing and productivity maintenance in the process industry.

Heater reliability often depends on periodic internal inspections and routine, on-stream monitoring/inspection. These techniques of tubes inspection provide adequate assistance in collecting data about their condition. Typical on-stream inspection programs incorporate visual examination of the firebox, external visual examination of casing and components, infrared examination of tubes and heater casing, and monitoring of tube-skin thermo couples. Before the inspection, the tools needed for inspection should be checked for availability, proper working condition, and accuracy.

External and internal inspections should be scheduled periodically considering the age of equipment, conditions of operation, type of equipment, kind of fuels, previous inspection result, etc. However, the length of time between internal inspections should consider the historic and predicted deterioration rates for components (including the impact of any process change), the historic inspection findings, the results of on-stream monitoring/inspection, previous maintenance activities and their quality.

### REFERENCES

- [1] A. Al-Meshari, M. Al-Rabie, M. Al-Dajane, Failure Analysis of Furnace Tube, *J Fail. Anal. and Preven.* (2013) 13:282–291.
- [2] A. Shibli, S. Holdsworth, Creep and fracture in high-temperature components—Design and life assessment issues, *International Journal of Pressure Vessels and Piping* 85, 2008.
- [3] A. Reihani, S.A. Razavi, E. Abbasi, A.R. Etemadi, Failure Analysis of Welded Radiant Tubes Made of Cast Heat-Resisting Steel *J Fail. Anal. and Preven.* (2013), DOI 10.1007/s11668-013-9741-y.
- [4] D.J. Tillack, J.E. Guthrie, Wrought and cast heat-resistant stainless and nickel alloys for the refining and petrochemical industries, Nickel Development Institute, Technical Series No. 10071, Toronto, 1998.
- [5] Jakobi and Gommans, Typical failures in pyrolysis coils for ethylene cracking, *Materials and Corrosion* 2003, 54, No. 11.
- [6] Seung, Hoon, Nahm, et. al., Degradation evaluation of HK-40 steel using electrical resistivity, *International Journal of Modern Physics B*, Vol. 17, Nos. 8 & 9, pp.1615–1620, 2003.
- [7] T. Filetin, F. Kovačiček, D. Lisjak, Analiza mikrostrukturnih promjena u materijalu cijevi peći za pirolizu, *Tehnički vijesnik* 4(1, 2)13-17(1997), Zagreb.
- [8] V. Guttman, R. Burgel, *Corrosion and Mechanical Stress at High Temperatures*, Applied Science Publishers, Ltd. London, 1980.
- [9] Z. Odanović, I. Blačić, D. Vračarić, V. Grabulov, Ispitivanje uzroka loma katalitičke cevi od vatrootporne legure HK 40, *Tehnički izveštaj VTI 04-01-0196*, 1999, Beograd.

## EXPERT SYSTEMS FOR TECHNICAL DIAGNOSTIC

Rob Decaban<sup>1</sup>, Saša Stupar<sup>2</sup>, Zoltan Kazi<sup>3</sup>, Ljubica Kazi<sup>3</sup>

<sup>1</sup>Western University London Ontario, Canada

<sup>2</sup>Pactiv Ne, London, Ontario, Canada

<sup>3</sup>University of Novi Sad, Technical Faculty "Mihajlo Pupin", Zrenjanin, Serbia

e-mail: zoltan.kazi@gmail.com

**Abstract:** Although explanation capability is one of the distinguishing characteristics of expert systems, the explanation facilities of most existing systems are quite primitive. This article describes an example of the application of the expert automated diagnostic system to the successful diagnosis of machine tool spindle bearing problems.

**Key words:** expert system, maintenance, diagnostic

### INTRODUCTION

The majority of machines in the industry are very old and their calculated life time is over. In spite of that they are in exploitation and it happens that they stop to work or cause harmful damages. Their safe work is on very low level. Sometimes a damage to a rotating machine causes the whole working process to stop. To prevent the system of damages, the monitoring of vibrations is recommended. In the last decade, several effective methods for the detection of machine and equipment primary defects detection in incipient stages of development have been designed. These methods are based fundamentally on the analysis of high frequency vibration.

The so obtained data would give the information about the working conditions of the rotating machines but also about the initial damages.

The level of the required training of the operator in diagnostics is another very important feature of the condition diagnostic system. Using the level of operator training as a criteria, the diagnostic systems can be divided into three groups:

- The first group is **professional diagnostic systems** in which the operator chooses the diagnostic technique and measurement instrumentation. The experience and knowledge of the operator completely define the depth and accuracy of the condition diagnosis and prediction.
- The second group is **expert diagnostic systems**. These systems answer the typical questions of an operator, i.e. they help an operator to find solutions in certain cases. The expert systems can be used by operators with special training but without the knowledge and experience of an expert.
- The third group is **automatic diagnostic systems**. These systems are based on methods that allow automatic diagnostics. Automatic systems define for the operator the measurement route and do not require any special training in diagnostics.

### MASHINERY FAULT DIAGNOSTICS

The machine selected for this case study was a 6 axis milling machine. The machine is quite complex from the point of view of machinery vibration analysis. Detailed diagrams illustrate the level of documentation of a machine's internal detail that is necessary for accurate machinery fault diagnostics. Without good detail information, unequivocal and accurate analysis of a machine's vibration data is nearly impossible for a skilled analyst. The same is true when analysis is to be handled by an automated expert software system. The presence of several gear meshes, bearings and shafts rotating at different speeds inside the machine presents an especially difficult challenge for vibration analysis. However, by using the subject expert automated diagnosis system, was able to detect and trend spindle bearing wear as it emerged and became more severe.

## CREATING OF DATA BASE

It is first necessary to document the internal mechanical details of the machine. This documentation process reveals the information that is needed to properly select vibration test locations and optimum analysis ranges. In this case, vibration test analysis ranges were chosen to span 0-10x spindle shaft rotation frequency for low range vibration data, and 0-100x spindle shaft rotation frequency for a high frequency range test. Collecting vibration data over two analysis ranges provides adequate data with optimum frequency resolution at the lower order shaft harmonics and at bearing tones, plus high resolution data that encompasses the gear mesh frequencies, gear mesh frequency harmonics, and higher frequency bearing information.

Once the machine's internal configuration has been documented and sensor locations chosen, the important machine configuration details are entered using a fairly simple one-time question answer session during which the software prompts for needed shaft speeds, gear tooth counts, and relevant test positions. These details describe the entire assembly from motor to spindle and are utilized for automated analysis of the vibration data collected. Major components in the machine were identified as a motor, a multimesh gearbox, and a machine tool spindle.

### Setting the Vibration Baselines

After the database was setup, the machine was monitored for several months before it began to exhibit any signs of trouble. During that time, a set of baseline signatures that characterized the machine's "normal" vibration signatures was developed. With the averaging utility, the user can select vibration tests that are representative of a well running machine and include them in a developing database of average data to define acceptable vibration levels. The averaging process automatically normalizes each selected vibration spectrum to the machine's running speed at the time the machine was tested and adds the data to the growing file of averaged spectra for all the machines of that identical make and model in the plant. The averaged spectral files contain averaged, speed normalized vibration signatures that are used to determine if newly collected machinery vibration data contain evidence of machine problems. This baseline establishment process eliminates the need for setting "alarm thresholds" for every frequency of interest in every spectrum to be measured. analysis.

## EXPERT SYSTEM DIAGNOSTIC METHODOLOGY

Expert systems for technical diagnosis systems represent a new generation of software for modern automated factories. The reasons for their application in maintenance (and for the application of Artificial Intelligence) , can be expressed as the following facts:

- requirements for elevated levels of intellectual work, class expertise,
- requirements for complex decisions based on a large number of alternatives, often based on incomplete knowledge,
- requirements for complex "on-line" information at the factory "paperless"
- ensure a high level of coordination of all phases of the Maintenance Department (and process).

The characteristics of expert systems for diagnosis resulting from the following requirements:

- to minimize the probability of no diagnosis made,
- time of diagnosis to a minimize,
- to integrate knowledge, historical data about work of equipment, knowledge based on physical laws,
- knowledge -based and functional description of the machine ,
- understanding of the different types of problems,
- the possibility of— expanding and maintaining the knowledge base.

Expert systems for diagnosis based on the recognition that different classes of functional structure of diagnosis system are fundamental elements of the blocks of knowledge. Diagnostic recognition relates to:

- class of recognition ( objects , operations, data)
- relationships between classes, which establishes the relationship between the objects and operations a — space of recognition.

Space can recognize that there are three levels:

- level of the real world that refers to the area of origin and corrective diagnostic problems ,
- level perceptual world in which editing is performed diagnostic information and perform diagnostic reasoning,
- level reflective of the world that is related to predictive models of human or artificial symbols.

The construction of an expert system for diagnosis is performed on the line of communication: Expert maintenance - Knowledge Engineering - computer. So the engineer - engineer the knowledge bottleneck between experts in the field of diagnostics (and maintenance) and the computer to which they are formalized, for example, the expertise of a diagnosis of the machine. One important issue is the acquisition of knowledge. It is a process of transferring and transforming knowledge of an expert (for example, the maintenance of the state of the vibration level of a component of the machine) .

The basis for the expert system for the diagnosis are:

- experience gained in the construction of the previous generation of expert systems for maintenance, especially in the field of diagnostics ;
- the theory of design and construction of expert systems in the field of technical diagnostics;
- application of new engineering principles and knowledge in order to develop expert systems in this field ;
- intensive development of the theory of system design.

Basic stages of development of an expert system for diagnosis are presented.

The first phase is to identify which conditions the further work on the construction of an expert system. It defines the following set of questions and answers: who are the stakeholders and their role in the development of expert systems, the characteristics of the problem to be analyzed, resources and goals.

The conceptualization of the second phase in the development of expert systems, in which concepts are defined for representing knowledge. They are based on the answers of the following questions: what types of data are available (a database of technical systems, documentation, manual maintenance), which are identified using the hypothesis (maintenance strategies), the relationship of objects in the definition of the field, which flows information and defining the concept of knowledge to solve problems of knowledge that is used to verify the solution .

Based on the concepts defined in the previous phase is carried out the design of structures for the organization of knowledge through a phase of formalization. It includes three important factors: the hypothesis space, modeling processes and data characteristics.

Phase of implementation (execution) involves a prototype expert system , which means it was built and the knowledge base, that is defined by the model of knowledge representation. For knowledge representation in expert system for diagnosis usually use the same principles and criteria used in the construction of artificial intelligence expert system for maintenance. These include: consistency ( whether methods provide all the important distinctions between the concepts that also represent ) the presentation of the structure ; computational efficiency; convenience to change; conciseness; uniform representation; logical integrity; adequately ability to search ( search in advance, back combined, heuristic) .

Finally, we stress that the essential problem of engineering knowledge in artificial intelligence as well as how to define the search strategy in the area of knowledge base. The last step in the development of expert systems is the exploitation phase experiment. In this final stage of development of the system



testing is performed on a real example. Based on the feedback effects of the test results may lead to amendment, supplement training, as well as the reformulation requirements on which the design and draft the new structure for the organization of expert knowledge of the upgraded system.

After the documentation and database setup are complete, and after a valid average data file has been built, the user collected data on a routine basis and analyzed the spectra using the expert system.

The expert system first detects the running speed of the machine, the scans the data for peaks which exceed the average baseline. Peaks at expected frequencies based on the machine tool's components are extracted first, the any significant peaks at non-synchronous frequencies are extracted. The high frequency spectra is examined for harmonic content using Cepstrum methodology and the results of this examination provide the basis for determination of the presence of bearing wear. These screening and cepstrum processes are discussed in following sections.

This accumulative collection of peaks, their levels, frequencies, and exceedances over the baseline serves as input to the backward chaining inference engine which checks for the existence of faults based on the pattern of vibration peaks observed at each component of the machine tool. Existing faults are assigned a severity based on the amount by which they have exceeded the baseline, and their absolute levels.

Upon completion, the expert system software automatically prints a plain language machinery fault report. The most valuable report from the Expert system software is the Machine Fault Trend Plot. This plot summarizes the past diagnostic findings by quantifying the fault severities and illustrating the change in severity over time to allow trend analysis of particular faults not just levels. This is not a plot of vibration amplitude trends. It is a trend of the seriousness of detected faults in the machine. It represents the conversion of all the collected vibration data from each machine into "bottom line" machine condition information in a single graphical presentation.

### **Vibration Data Screening**

The screening of vibration data was developed to provide a matrix summary of spectral peaks as a time-saving aid to human analysts. The same screening routine is incorporated in the subject expert system and produces a screening output table which includes the following information for each test location and axis:

- Amplitudes at each of ten pre-selected, specified orders, which are referred to as screening criteria or fault codes. Simple examples of specified orders include 1X and 2X (one and two times rotational rate), MB (motor bar pass rate), PV (pump vane rate), GR (reduction gear mesh rate), and FDN (foundation resonance).
- Amplitude and rotational rate order of the two highest peaks in each of the low range and high range spectra, excluding the ten specified peaks.
- A "floor" level below which are the amplitudes of 75% of the remaining spectral lines of the high range spectrum.
- For each of the above, the change in amplitude from the previous survey and its deviation from average plus sigma.

Thus we have 14 distinct peaks plus the "floor" noise level tabulated for each axis, or 84 peaks for a machine with two data test locations. Screening tables typically are printed as a convenient source of data review, along with the spectral graphs, for those who wish to examine the basis for the expert system report.

### **Cepstrum Analysis for Bearing Wear Detection**

Since indications of bearing wear are not confined to the fundamental bearing fault frequencies, but often appear at higher order harmonics and shaft rate sidebands of these frequencies, a automated routine was developed to detect and identify non-synchronous harmonics and sidebands in the frequency spectrum using cepstrum. Characteristic peaks in the cepstral data occur at positions corresponding to frequencies at which there exists a strong series of peaks or spacings in the spectrum. A machine with a faulty anti-friction bearing may show a harmonic series of peaks with 3.12 times rotational rate spacings in the spectral data. This series of peaks are exhibited in the cepstral data as a single peak at a position corresponding to the frequency of 3.12 times rotational rate. The four highest

fundamental peaks in the cepstral signatures between 2.0x and 8.0x are extracted. Correspondence between cepstral data and screened spectral data is checked systematically by numerous comparisons between the fundamental cepstral peaks and their harmonics and 1x sidebands, and the screened spectral peaks. If a positive correlation is found, the corresponding peaks may be considered bearing tones if other criteria are met.

A fundamental assumption used in the expert system methodology is that the health of the machine as a whole can be assessed by isolating the spectral data pertinent to each major component and, based on the data, diagnosing faults by component. Comparison of spectral data of the component being analyzed to equivalent data at tests of adjacent components allows the expert system to determine which component is the most probable source of the detected fault. This concept is particularly useful for imbalance and bearing wear diagnoses. Proper identification of the major components of a given machine and the location of test points in relation to each component is key to this type of approach and is accomplished through a system of numerical coding.

Details of machine configuration such as minor component arrangement, types of bearings, gearbox details and coupling types are stored in the knowledge base via a component coding scheme. This scheme assigns a numerical code to each known type of arrangement and, along with the code, the test location numbers associated with the component. Major component groups have been defined as follows: Close-coupled Machines, Centrifugal Compressors, Turbines, Reciprocating Compressors, Motors, Screw Compressors, Gearboxes, Lobed Blowers, Linked Drives, Generators, Centrifugal Pumps, Purifiers, Rotary Thread/Gear Pumps, Couplings, Rotary Sliding Vane Pumps, Diesel Engines, Reciprocating Pumps, Marine Propulsion Gearboxes, Fans, Machine Tool Spindles.

### THE FAULT DIAGNOSTIC

Analysis of each of the major component groups requires that a unique set of frequencies of interest be extracted from the screening matrix and examined. There are two basic processes that lead from the screening output matrix to the diagnostic report. The first process transforms the screening matrix into a set of Component Specific Data Matrices (CSDMs). The second process analyzes the vibration data in each CSDM by passing the two-dimensional array of numerical values (vibration amplitudes and exceedances of average) through a series of diagnostic rule templates that serve to pass or fail each individual fault diagnosis and compute a relative severity. Testing a motor driven centrifugal pump with a coupling, for example, the single screening output matrix of the test spectra would be transformed into three CSDMs (motor, coupling, pump). Each CSDM in turn would then be "masked" through a whole series of diagnostic rule templates pertinent to that major component group.

The CSDM has a form similar to the screening matrix in that its rows are designated by test location and axis, with vibration amplitudes and exceedances of average plus sigma. Furthermore, there are rows designating similar data for adjacent components and the differences between components. Column designations go beyond individual peaks at specified orders. In transforming the information given in the screening matrix, the specified orders are consulted for principal frequencies of interest such as shaft rotational rate, pump vane rate, gear mesh rates, turbine bucket rates and so on. Harmonics of such principal frequencies are also examined as well as rotational rate sidebands off the principal frequencies and their harmonics. The screening matrix specified orders rarely contain all frequencies sought by the CSDM generation program and when a frequency is not found or expected as a specified frequency, the unspecified maximum peak orders are checked to see if their frequency is that sought. This method allows for the filling of many more frequency columns in the CSDM than are specified in the screening matrix.

Ball bearing wear for various major component groups is detected by generating columns in the CSDM tables that include peaks from the unspecified maxima in the screening matrix that are non-integer orders of rotational rate and have been flagged by the cepstrum harmonic analysis. Prominent, known bearing tones identified in the average spectra sometimes are also included as a specified order. For each major component group, the CSDMs have a unique form allowing for the identification of each element in the matrix by row and column numbers. Each diagnostic rule template is keyed to this row and column specification and consists of sets of logic symbols addressing specific row-column elements of the CSDM and up to 5 more specific rules which test the data through inequalities. The logic symbols used are assigned a row-column address and act as qualifiers for each rule template. If

the logic symbols are satisfied and the specific inequality rules are satisfied, the template passes and the diagnosis is considered true.

Once a fault diagnosis is declared, a relative severity needs to be determined. This fault severity is determined by defining a diagnostic score as the margin of actual values in the CSDM over the threshold values required by the rules for any particular fault. This diagnostic score is then compared to an adjustable nominal score set for each fault. If the ratio of the two is less than 1, then the problem is considered slight. Ratios up to 3 are given a moderate severity, between 3 and 6 is serious, and above 6 is considered extreme.

The linear numerical scoring system used to determine fault severity is well suited to provide trending of severity over time, from survey to survey. For each specific mechanical fault diagnosis that is detected at least to a "slight" degree for a given machine, the severity score can be plotted using time as the abscissa. The ordinate does not directly reflect the numerical score. These remain internal to the program. Thus multiple faults can be trended independently for a machine on the same graphical plot.

## CONCLUSION

A new generation of rotating machinery monitoring and detailed diagnostics systems now exists using vibration, enabling the maintenance and repair of the main and auxiliary equipment in the metallurgical industry according to its real condition.

The expert automated diagnostic system represents the kind of a highly effective maintenance resources available that provides accurate detection and diagnosis of faults in highly complex precision machinery without a staff of highly trained vibration analysts. Critical to the success of the Expert system software are detailed documentation of machinery vibration sources and a simple method to establish an empirical baseline for acceptance criteria. The system must also provide a flexible rulebase together with adjustable sensitivity so that it can accommodate a wide variety of machinery types from smooth running high precision machines to rough running heavy machinery.

Each logic symbol can be assigned to any vibration amplitude or exceedance of average plus sigma in a CSDM. Rule templates also can incorporate up to 5 inequality rules which enable the user to compose if/then statements, to add elements of the CSDM together or to ensure that certain amplitudes or exceedances are greater than or less than others.

Repair decisions can be made based in part on a combination of absolute fault severity and its rate of increase, and in part on the type and number of indicated faults.

## REFERENCES

- [1] A.V. Barkov, N.A. Barkova, A.Yu. Azovtsev: "Monitoring and Diagnostics of Rotating Machines by Vibration", VAST, Inc., Saint Petersburg, 1997.
- [2] Devedžić, V.: Ekspertni sistemi za rad u realnom vremenu, Institut "Mihajlo Pupin", Beograd, 1994.
- [3] Jackson, P. C., Introduction to artificial intelligence, Dover Publications Inc., New York, 1985.
- [4] Maus, R., Keyes, J.: Handbook of Expert Systems in Manufacturing, McGraw-Hill, Inc., 1991.
- [5] Mockler, J. R.: Knowledge-Based Systems for Management Decisions, Prentice-Hall International, Inc., 1989.
- [6] Petrovic, Lj.: Effectual Systems for Vibration Analysis and Predictive Maintenance of Turbogenerator, M. Sc. Thesis, Technical Faculty "M. Pupin", Zrenjanin, 2003.
- [7] Petrović, Lj, Adamović, Ž.: Expert Systems for Maintenance of Technic Systems, Manufacturing and management in 21st century, Skopje: University "Ss. Cyril i Metodius", Faculty of Mechanical Engineering, 16-17 September, 2004,
- [8] P. Hotomski, Systems of Artificial Intelligence, University of Novi Sad, Technical Faculty "Mihajlo Pupin" Zrenjanin, 2004. (in Serbian)
- [9] Z. Kazi, Using Remote Databases in Automated Reasoning Systems, Master's thesis, University of Novi Sad, Mihajlo Pupin Technical Faculty, Zrenjanin 2005.

## **SESSION 5: Design and Maintenance of Process Plants**

## DESIGN OF NEW PORTABLE VERTICAL CONE PENETROMETER

Jozef Bajla<sup>1</sup>, Dušan Hrubý<sup>2</sup>

<sup>1</sup>Slovak University of Agriculture in Nitra, Department of Machine Design, Faculty of Engineering, Slovak Republic

<sup>2</sup>Slovak University of Agriculture in Nitra, Department of Electrical Engineering, Automation and Informatics, Faculty of Engineering, Slovak Republic

e-mail: [jozef.bajla@uniag.sk](mailto:jozef.bajla@uniag.sk)

**Abstract:** This paper describes new portable vertical penetrometer design for the agricultural soil compaction measuring. The Department of Machine Design and The Department of Electrical Engineering, Automation and Informatics on FoE SUA in Nitra are currently preparing a new measuring system with modern electronic parts as well as application of new measuring principles for depth and force sensors. Design has a new arrangement of the elements in the body. Major innovation is the use of a colour touch screen which one allows real time monitor: the laboratory measurements, the measured data saved on SD card, Excel and formatted data, the ultrasound sensors values for the indirect ground depth measuring, the user friendly setup options of the device parameters and the incorporation of GPS into the device housing. Connection with personal computer remained unchanged from the previous type. In this paper is described the enhanced algorithm for penetration resistance measuring of a soil in dependence on depth and on place of the pushed sensing head.

**Key words:** soil compaction, portable vertical cone penetrometer, penetration resistance measurement, cone index

### INTRODUCTION

Harvesting, sowing and protection and mechanisms for tillage negatively affect soil compaction despite new design solutions, especially in extreme weather conditions.

There is necessary to have detailed and accurate information about the condition of land and constantly specifies those models of the soil particles spatial arrangement for finding appropriate solutions to minimize soil compaction. Monitoring of soil compaction is performed mainly by penetrating devices which are mainly used in mapping the immediate condition of the soil.

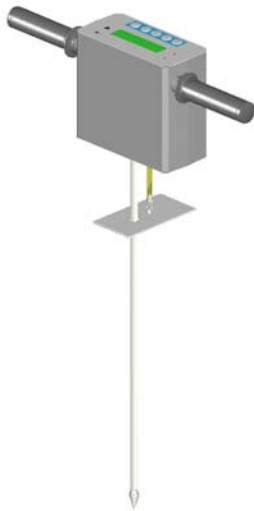
Soil compaction is most often defined by penetration resistance (Cone Index, CI) when measured cone and sensor, measure the value of the resistive force exerted per unit area at the base of the cone. To ensure comparability and reproducibility of results and objectively assess the changes of soil compaction it is used standard size cone by American standards ASAE S 313.3. This article describes the design of a new penetration device designed at DMD and DEEAI at FE SUA in Nitra (Slovakia) and the first results in the implementation of this device.

### MATERIAL AND METHODS

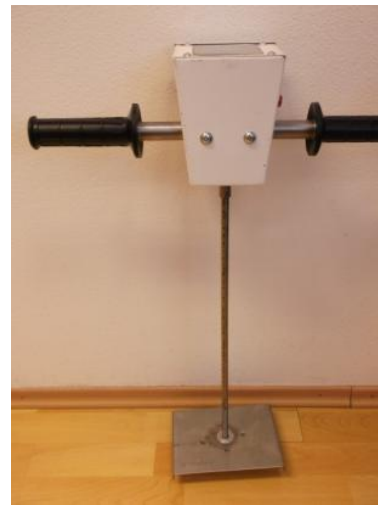
Microprocessor and computer technology and research and development in this sphere influences on the development of penetration devices in positive direction due to which we can make the measurement quickly and results processed into more transparent and comprehensible form. The cooperation of work between DMD and DEEAI at TFE SUA in Nitra (Slovakia) was made 15 years ago penetrometer P-BDH 3A (Figure 1).

This penetrometer was founded on the principle of sensing the force of soil resistance against solid shape (cone) pushed into the soil by capturing incremental value after pressing deeper every centimetre. For measurements were used optoelectronic measurement systems, digitization and record of measured values in memory, which was transported into a computer and processed further. The measuring device was very simple and reliable with over 10,000 possible record data. Through digital indicator can be adjusted input parameters, calibrate the device and check the measured data values. Wide application of penetration method just for its benefits will likely continue in other areas. Increasingly sophisticated equipment available with electronics and modern processing methods and

evaluation techniques can position the field tests keep at the forefront of scientific and agricultural interest.



**Figure 1.** Penetrometer P-BDH 3A



**Figure 2.** Penetrometer PE 90

Years of experience in the measurement and evaluation of measurement the authors prompted to upgrade the device so as to remove some of the shortcomings of the device in terms of measurement system, as well as increased measurement comfort and control. During the measurement at P-BDH 3A was not possible to follow the course of the measured forces, depending on the depth and it was not able to locate the measurement location by a GPS system.

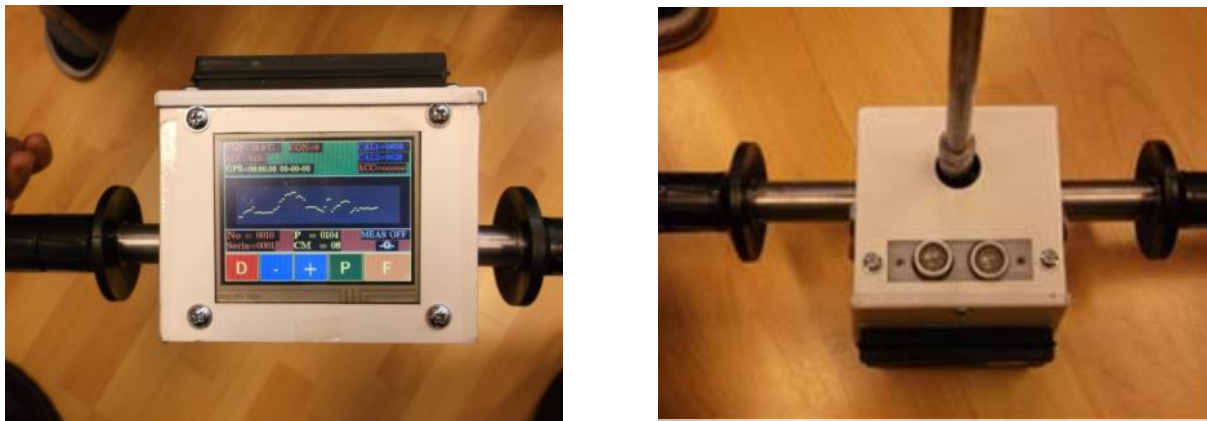
Finally, the authors decided technical and technological improving to meet the new requirements of the practice. The concept of the new device was based on the requirement of control options during the penetration resistance measurement and so extreme values (errors) can be immediately erased. It was also our aim to prepare a reliable measuring instrument with a low price that was unlike now commercially produced devices cheaper and more accessible for practice (Figure 2). Therefore into this new concept were applied commercially produced force and depth sensors (ultrasonic sensors) modern electronic and microprocessor technology, including the use of a colour touch screen.

## RESULTS AND DISCUSSION

Penetrometer marked as PE 90 is new variant of penetration device, which consists of a steel casing, cut out and welded out of sheet metal which one is associated with the metal housing with countersunk screws. To this housing is bolted carrying case with attached handles inside which is fixed force sensor (Liška, 2008), the bottom of the sensor is attached to the rod with cone probe. On the top of the metal cover is placed colour touch screen (Figure 3a). To measure the force of resistance was chosen sensor type EMS 20 with a measuring range up to 5 kN, which has minimal dimensions (Emsyst, 2008).

At the new concept were used current possibilities of modern electronic and microprocessor technology. The device uses a colour touch screen for entering measuring conditions, parameter setting and control over the measurement on the display screen.

There is mounted ultrasonic sensor for measuring of depth to the bottom of the housing, and is clamped sliding reflector plate to ensure a correct reflection of the ultrasonic signal to the measuring rod (Figure 3b). The device can be externally connected to a computer to export data and GPS position for their further process. It has the ability to connect to an external power source with controlled charging of battery capacity. Handles, measuring rod and the GPS sensor is removable, which allows better storage-ability and its transfer.



a) b)  
**Figure 3.** Device view: a) view on display unit, b) location of ultrasonic probes

Measurement algorithm of penetrometer resistance depending on the soil depth should take into account the following aspects:

- the measuring system have to do the calibration of sensors due to temperature after power on (1),
- to determine of the GPS signal activity,
- measuring rod speed in the recess have to be max.  $0.01 \text{ ms}^{-1}$ ,
- device has an audible alarm to warn the possible destruction of the force sensor under strong recess,
- in case of the wrong methodology recess irregular movements of measuring rod, for example impact on stone or finding an air gap, attention to the possible incorrect results.

Built-in temperature sensor is used to calibrate ultrasonic sensor distance covered by the adapted known equation:

$$s = (165.9 + 0.305 \cdot (T_s - 273.15)) \cdot t \quad (1)$$

where:  $s$  - is sensed soil depth, m  
 $T_s$  - is air temperature, K  
 $t$  - is measurement time interval, s

After the first layout of the components in the new device were resolved other parts like battery, location of some controls, GPS sensor, battery charge and computer connection. It has got GPS sensor with SiRFstar III chip, which in addition to determining the exact position of measurement what also provides information about the current altitude and the time of measurement. Values of ambient and soil temperature is an additional indication of measurement. The measured data are stored on the microSD card format in \*.csv file that is readable in MS Excel or other spreadsheets (Géci, 2007).

Today a new variant of penetration device PE90 shown is designed with the technical characteristics shown in Table 1:

**Table 1.** Technical characteristics of PE 90

Measuring range	0 - 10 MPa (cone index)
	0 - 600 mm (measurement depth)
Measuring step depth	10 mm
Number of measurements	cca 100 000 on 256MB microSD card
File type	.csv (.txt, .bin)
GPS module	SirfStar III
Connectivity	USB, RS232C, SD card
Unit Dimensions	120 x 140x 90 mm (body)
Length of the rod	600 mm
Weight	2.6 kg
Size cone (diameter of base / top angle)	12.8 (20.3) mm/ 30°
Battery life	min. 10 hours

Nowadays is well known companies Eijkelkamp Penetrologger that has a measuring range up to 10 MPa, measuring the depth in interval 10 or 20 mm, depth measurement is max. 800 mm. Cone used for measuring has got angle of 60° on special request also available with cone according to ASABE. The device can be added with GPS without connection to system memory.

ELE International Company offers Proving Ring penetrometer with ASABE cone, it has analogue pointer without electronic record of the measured resistance and depth and no GPS. A few years ago they offer ELE CCP model with a measurement range up to 600N, depth measurement up to 450mm with a reading offer 15mm, 16 digit display with record up to 600 measurements. Currently, it is not in the catalogue.

Australian company AGRIDRY RIMIK PTY LTD in Toowoomba offers RIMIK CP 40 CONE, which one has advanced electronic components, display unit, strain gauge force transducer with a measuring range up to 5.5 MPa and depth measurements up to 600 mm at the rate 15, respectively 20 mm. It also has a built-in GPS. Measuring capacity is about 2047 measurements. This device appears to be the most advanced on the market.

It may be noted that the PE 90 penetrometer has comparable properties with worldwide manufacturers. However, our penetrometer has improved the intuitive management and has bigger recording memory.

## CONCLUSION

The reason for the research and development of new penetrometer equipment is not only to design lightweight, portable and reliable equipment, but also a consistent device enabling a wider usable and able to obtain data comparable to each other.

Modern penetrometer devices except the new options (GPS, colour touchscreen, high memory capacity, autocalibration) must take into account the versatility and ease of use in a variety of conditions by affordable price. The new proposal penetration device can meet all these requirements and provide greater comfort and productivity.

## Acknowledgements

This article was generated on the base of solving project VEGA 1/0009/09 (Using of evaluation indicators the influences of tillage technologies under space variability of soil properties) of the Science Grant Agency MŠ SR a SAV.



## REFERENCES

- [1] Bajla, J. 1998. Penetrometrické merania pôdnych vlastností. Metódy, prístroje a interpretácia. Monografia. 1. vyd. Nitra, VES SPU Nitra 1998. 112 s. ISBN 80-7137-543-8.
- [2] Géci, T., Lukáč, O. 2007. Porovnanie formátov súborov pre spracovanie dát nameraných prenosnými meracími prístrojmi. In: Informačné a automatizačné technológie v riadení kvality produkcie, 5.-7. septembra 2007 Nitra : SPU 2007. ISBN 978-80-8069-927-7, p. 37-41.
- [3] Emsyst s.r.o.:*[online]* [cit.2008-10-7]. Available from: <<http://www.emsyst.sk/>>
- [4] Líška, E. 2008. Všeobecná rastlinná výroba. 1. vyd. Nitra. 2008. Slovenská poľnohospodárska univerzita. 2008. 452 s. ISBN 978-80-552-0016-3.
- [5] Raper, R.L., Kirby, J. M. 2006. Soil Compaction: How to Do It, Undo It, or Avoid Doing It. In: *ASAE Distinguished Lecture Series No. 30, pp. 1-14*. 2006
- [6] Rataj, V. 2000. Geografické informácie pre poľnohospodárstvo*[online]*. Available from: <http://www.cddesign.cz/h/clanky/ar.cesp?ARI=19>
- [7] Tekeste, M., Z. 2008. Site - specific characterisation, modeling and spatial analysis of subsoil compaction (hardpan) for precision agriculture on south-eastern US soils. *[online.]* Available from :[http://www.ifaanet.org/Social%20Science/mehari\\_zewde\\_tekeste\\_j\\_phd\\_40606.pdf](http://www.ifaanet.org/Social%20Science/mehari_zewde_tekeste_j_phd_40606.pdf)
- [8] Tekin, Y. - Kul, B. - Okursoy, R. 2008. Sensing and 3D mapping of soil compaction In: *Sensors* 2008, 8, 3447-3459
- [www.ejkelkamp.com](http://www.ejkelkamp.com)
- [www.eleinternational.com](http://www.eleinternational.com)
- [www.agridry.corn.au](http://www.agridry.corn.au)

## SUSTAINABLE PROJECTS AS INSTRUMENTS OF SUSTAINABLE DEVELOPMENT

**Armin Kovači**

University of Herzegovina, Faculty for Management of Resources”, Mostar, Bosnia and  
Hercegovina

e-mail: [armin.kovaci@live.com](mailto:armin.kovaci@live.com)

**Abstract:** This work analyzes possibilities of adopting a new approach to project management in order to increase sustainability of projects and its broader environment. Majority of human activities are smaller parts of larger projects and has effects on its broader environment. Some interesting questions arise out of this problem. How to adopt sustainability principles in different phases of a project management cycle? Which factors need to be considered when adopting sustainability factors in project management? What are the indicators of adopted sustainability in project management? This work will also offer a new definition of sustainable projects.

**Key words:** sustainability, project management, environment

### INTRODUCTION

The world today is not the same place to live as it was before 10, 20, 50 or 100 years ago. Many things have changed in the past and will change in the future, but one thing remains a constant, our planet. Before the industrial revolution nature possessed a large enough capacity to rebuild and recover from various human influences. After industrial revolution mankind has generated immeasurably greater impact on environment, than in earlier periods. Planet responds in countless ways- from floods, droughts to earthquakes and volcanic eruptions. Greater intensity of these occurrences is a consequence of human attitude to the environment.

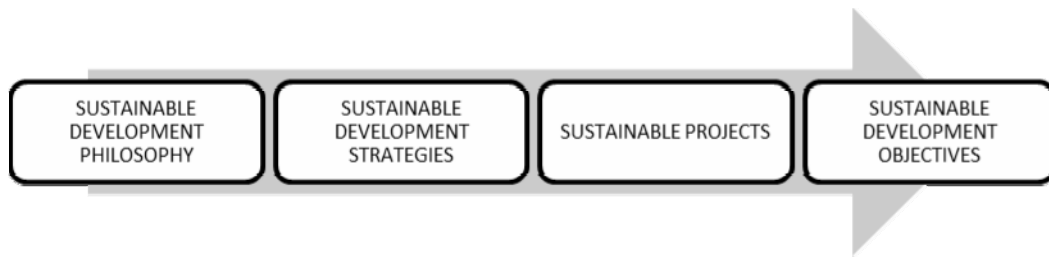
Human sustainable development represents conscious, free and participatory process of transformation of the relationship between people and their physical environment (natural and man-produced), with the intent to obtain to everyone legitimate and effective approach to the creation and use of tangible and intangible, as well as social and environmental values that are in their totality assumption of authentic full flowering potential of each and every person. This process both in its form and in content and meaning must guarantee the maintenance of life of the present and future generations of human and other living beings, [5].

### SUSTAINABLE PROJECTS

#### **The connection between sustainable development and projects**

Sustainable development represents a change in mindset compared to the way that most people today think. Existing problems can't be solved by using the same mindset that led to the creation of these problems. Therefore, the existing economic, environmental and social problems can be solved with new ideas which create win-win relations in these three different aspects.

The question that arises is: What is the best way to apply the principles of sustainability, which could soon become the principles of survival on this planet? The first step is to change a mindset that should result in concrete sustainable development strategies. However, the strategy itself is not a solution, but a path toward a solution. Strategy is a plan to achieve desired objectives. Sustainable projects represents an instrument for achieving sustainable development objectives.



**Figure 1.** The connection between sustainable development philosophy, sustainable development strategies, sustainable projects and sustainable development objectives, [6]

It has been said that implementation of sustainability implies change of a mindset. Today, majority of managers have opinion that adoption of sustainability principles means that they need to sacrifice their profits. If things are perceived in that way, then that would mean that those companies and other subjects need to sacrifice their economic power and competitiveness in order to adopt sustainability principles. Sustainable development and sustainable projects represents the opposite of that way of thinking. Adoption of sustainability and responsibility principles leads to increased competitiveness in the medium and long term. That is why an increasing number of studies are focused towards the sustainable competitiveness.. One of these studies is the Global Sustainability Competitiveness Index 2013 which analyzes the sustainable competitiveness of nations. Following table represents top five countries and rankings of countries of former Yugoslavia.

**Table 1.** Global Sustainability Competitiveness Index 2013, [3]

Rank	Nation
1	Denmark
2	Sweden
3	Finland
4	Norway
5	Switzerland
16	Slovenia
37	Croatia
42	Montenegro
50	Serbia
106	Bosnia and Herzegovina
144	Macedonia

### Adopting sustainability in project management

Project management is applied in various areas of human activity such as construction, shipbuilding, culture, sports, environment, information technology, etc. Here it is necessary to make a distinction between so-called everyday routine activities and those related to the projects (project activities). Routine activities are those activities or tasks that are related to the present and are repeated at intervals. Project activities are unique activities or tasks that are oriented to the future. Both types of activities have their costs and effects. According to the definition of PMI Institute project is a temporary endeavor undertaken to produce a unique product, service or result, [2].

Situation in the world today shows that sustainable development should have its place in project management. Adoption of sustainability principles in project management raises a number of questions that needs to be answered.

- How to adopt sustainability principles in different phases of project management cycle?
- Which factors needs to be considered when adopting sustainability factors in project management?
- What are the indicators of adopted sustainability in project management?

Project management cycle consists of five phases: initiation, planning, implementation/execution, control and monitoring, and closure of the project. Figure 2 shows results of research which had an objective to explore best ways to adopt sustainability principles in different phases of project management cycle.

In the initiation phase greatest impact on adoption of sustainability has a determination of project scope and definition. Way of thinking applied in this phase can result in (un)sustainability of the project. On the other hand, project scope represents a framework within which all project activities will take place. Importance of adoption of sustainability during defining of project scope is indisputable. For example, project scope for project „Start up of manufacturing plant“ can include or exclude the installation of air and water filters. Inclusion of such purifiers increases sustainability and responsibility of the project.

During the planning phase the most important activity is setting up SMART objectives. These objectives represents a target within all project activities are aimed. It is very important to use appropriate criteria when defining project objectives. For example, project „Bridge construction“ can use „lower cost“ criteria, as the most important criteria, during the planning phase. In this way, project managers and investors ignore importance of sustainability and responsibility for the local community. During implementation phase, the main focus of adopting sustainability is given to key processes. On the other hand, during control and monitoring phase, the main focus of adopting sustainability is given to support activities. The largest consumption of material, human and financial resources is conducted during implementation phase. This is why project managers can find the greatest possibilities of adoption of sustainability in this phase. This phase also represents the biggest challenge, because of the greatest number of interrelated activities.

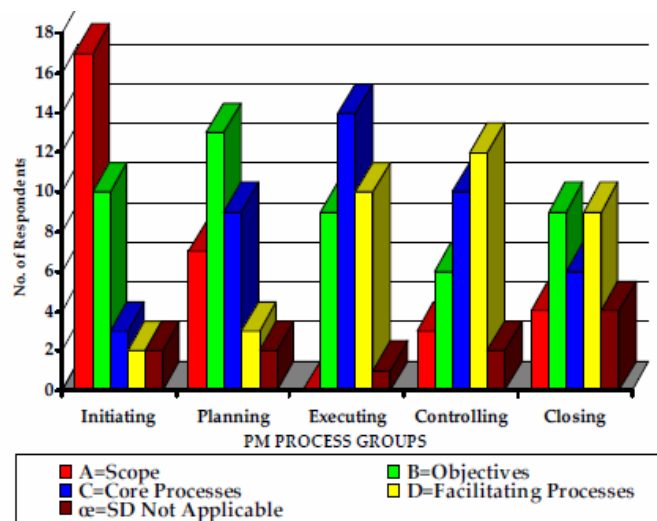


Figure 2. Adopting sustainability in different phases of project management, [1]

Analysis of objectives represents the biggest opportunity for adopting sustainability during the closure of the project. Importance of this analysis can be seen from Logical Framework Matrix (LFM). According to the LFM, every project is a an instrument for solving a problem, but a solution of this problem leads to need for a new project. In other words, closing of one project leads to starting up a new one. During the closing phase, project managers can analyse the quality of objectives of the previous project in order to increase performance of future projects.

### Indicators of adopted sustainability in project management

Indicators of adopted sustainability in project management are:

- application of environmental and social sustainability assessment,
- managing effects during the entire life cycle,
- adoption of Triple Bottom Line in project management.

The first indicator of increased sustainability of the project is *application of environmental and social sustainability assessment*. Today, feasibility studies are based on financial indicators. Increased sustainability of the project is in direct correlation with paying more attention to environmental and social aspects of the project. How much will the project be environmentally and socially useful for local community today, and how much for 5-10 years?

Today's projects are aimed at realizing outputs, lower and higher objectives and purpose of the project. Such focus is correct, also in terms of sustainability, but with one condition. It is necessary for project managers to take into account that all outputs, objectives and purpose of the project have effects during the entire life cycle of the project. Sustainability should not be realized in only some of the phases (e.g. only during the implementation phase). Managing a complete lifecycle of the project requires the observation of a much broader perspective, than that of traditional planned and implemented projects, covering all phases of planning, implementation and exploitation of the project. According to the parameters that are mainly used in project management today, a successful project is the project realized within the given parameters of time, scope and budget. The adoption of sustainability and responsibility in the project managements creates new constraints for existing parameters (time, scope and budget). These new parameters/constraints are: economic, environmental and social components of the project. Accordingly, parameters related to time, scope and budget should not be realized through project activities that violate constraints on economic, environmental and social sustainability.

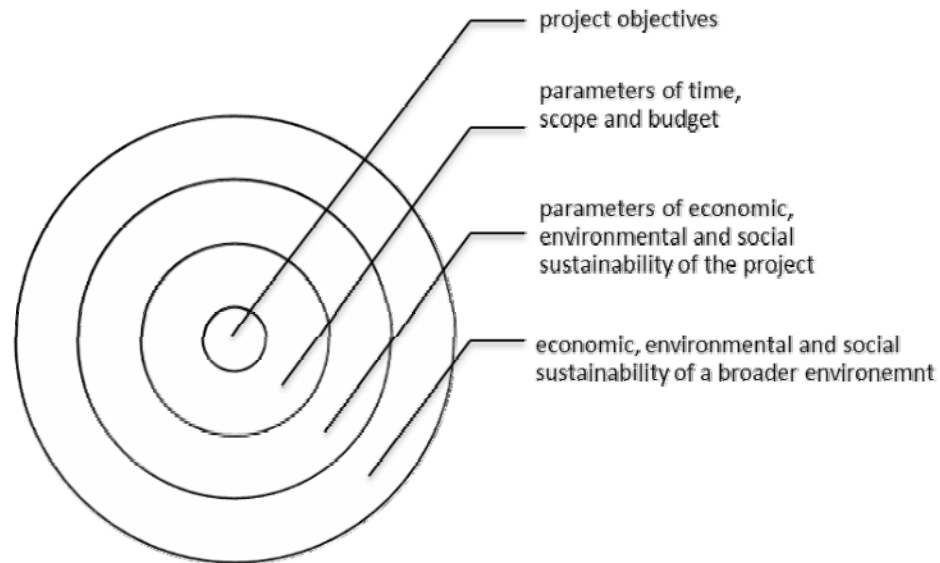
#### **Case 1: Construction of community building**

Project of construction of community building, kindergarten, should be completed within a year. Estimates indicate that the application of planned working dynamics and the construction materials will result in completion of the project within one and a half years. The project manager is under pressure to complete the project in a shorter period of time. Because of that, project manager has approved the use of low quality materials that can be more quickly incorporated into the object.

This illustrative example shows how achievement of basic parameters of the project does not mean the sustainability of the project and that the adoption of triple bottom line viability factors is necessary for long-term success of the project. Adoption of sustainability reflects in two main areas:

- Product use and the extent to which a product is contributing to quality of life, health and well being over time.
- Business practice and the extent to which a project is being managed according to practices that will contribute to sustainable development goals, [7].

It can be seen that the realization of economic, environmental and social sustainability of projects is used as an instrument to achieve economic, social and environmental sustainability of the broader environment. These different levels of parameters and constraints that must be respected in sustainable projects are illustrated in the Figure 3.



**Figure 3.** Economic, environmental and social sustainability in sustainable project management

This figure shows basic components needed for creating a definition of sustainable projects.

Sustainable projects are those projects whose goals and activities:

- are realised in a given parameters of time, scope and budget of the project,
- do not violate the constraints of economic, environmental and social sustainability of the project,
- and create a positive effect on the economic, environmental and social sustainability of the broader environment.

#### **Case 2:** Example of sustainable project-Costa Navarino, Greece

Hotel "Costa Navarino" is a new tourist destination in the Mediterranean. What makes this destination different from the others is its orientation towards economic, social and environmental sustainability. Project of construction of this complex provides a good example of adopting sustainability in project management.

Construction of the complex resulted in a large number of felled trees, but in the draft of project is planned the same number of trees to be planted in their new locations within the complex. The complex is designed to make optimum use of daylight. In addition, at the top of the complex is 5000 m<sup>2</sup> planted vegetation. Lighting on the beach is adjusted so it does not disturb the movement of sea turtles in the area. As for the power supply, hotel is fully powered by renewable energy sources (geothermal and solar energy). The golf course is planted with grass that requires 30% less water, and the water is supplied from its own reservoir. In addition, the golf course has a an information system that analyzes weather conditions and requirements for water so the water reserves exploited in an efficient manner. Natural fertilizers are used for the cultivation of plants. Waste management is based on the reduction, reuse and recycling of resources. Paper, plastic, glass, used oil, batteries, and organic waste are being recycled, [6].

#### **CONCLUSION**

Sustainable projects are instruments for implementation of sustainable development strategies. Their implementation leads to achievement of sustainable development objectives. Project managers need to adopt sustainability and responsibility principles in all phases in project life cycle. Adoption of sustainability principles means implementing a new set of parameters in planning, implementation and exploitation activities. Adoption of this parameters increases sustainability of the project and a broader environment. This work offered a new definition of sustainable projects that can be a base for analysis, discussion and research in this area.

## REFERENCES

- [1] Eid, M., Integrating Sustainable Development Into Project Management Processes, University of Edinburgh, pp 6-13
- [2] Project Management Institute, PMI Lexicon of Project Management Terms, pp 13, 2012.
- [3] SolAbility, The Global Sustainability Competitiveness Index, pp 7-47, 2013.
- [5] Trputeć, Z. Design of Human Sustainable Development and Economic Development, Croatian Lexicographical Institute, pp 40-59, 2010.
- [6] Trputeć, Z., Kovačić, A., Čurić, A., Šantić, N., Theory and Practice of Sustainable Development, University of Herzegovina, pp. 100- 155, 2012.
- [7] Warhurst, A, Sustainability Indicator and Sustainability Performance Management, University of Warwick, pp 10-74, 2002.

## KINEMATICS OF PISTON MECHANISM WITH THE USE ROTATING TRANSFORMATION MATRIX

Danilo Mikić<sup>1</sup>, Eleonora Desnica<sup>2</sup>, Aleksandar Ašonja<sup>1</sup>, Živoslav Adamović<sup>2</sup>

<sup>1</sup> The Serbian Academic Center, Novi Sad, Serbia

<sup>2</sup> Technical faculty "Mihajlo Pupin", Zrenjanin, Serbia

e-mail: [vtsm@open.telekom.rs](mailto:vtsm@open.telekom.rs)

**Abstract:** The paper presents results of application of matrix transformations that can be applied to solve kinematic mechanisms of machines, as well as their application in a variety of cases in resolving the kinematics of mechanisms, such as for: determination of the vector segments in different coordinate systems, determination of the position vector of joints, and the focus points of segments, determining the angular velocity and the characteristic points of the segment, determining the angular acceleration of the segment, and the characteristic points. The work is part of the scientific work that is being implemented at the Technical University in Zrenjanin for the development of industrial systems and its results are suitable in solving mechanisms (reciprocating mechanism) and can be used for other purposes in the different branches.

**Key words:** matrix transformations, kinematics, dynamics of motion, crankshaft, connecting rod, piston, piston mechanism.

### INTRODUCTION

Piston mechanisms can be to present the system of the body (segments) that are interconnected rotary and translational relationships, moving under the action of forces and moments. The segments that are interconnected are the kinematic chain consisting of three members: the crankshaft, connecting rod and ucrsne head slider, whose purpose is to convert linear motion into rotary and vice versa. The application of this type of mechanism is large in practice, especially in motor vehicles with internal combustion engines [4].

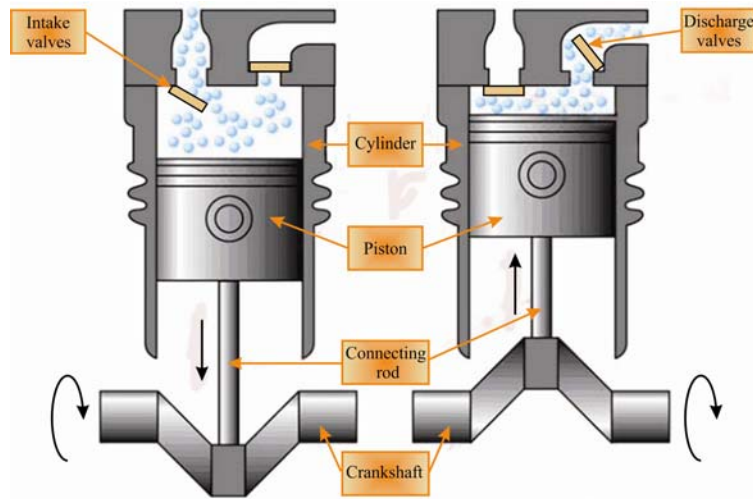
In a reciprocating compressor, a model that is presented in the paper, a cylinder with a reciprocating charging the suction line and empty the water pressure at the top of the piston. When walking down the piston, the cylinder is filled through the inlet valve, and when moving in the opposite direction, compressed air (compressed) through the relief valve. Pan piston, piston compressor, through the mechanism of the crankshaft turns in the rotation (Fig. 1), [5].

To control mechanism, it is necessary to know the mechanics or its kinematics and dynamics. The problem consists in solving the mechanics of the relative motion of the system of the body, which, due to the complexity of the model and the large number of degrees of freedom of movement is quite complicated. Taking into account the real needs in the design of mechanisms, the problem can be generalized and simplified using matrix transformations. Given that so far there is no generally applicable method for this solution are listed here the results of some studies in this area carried out for the piston rotating models using matrix transformations. Special technique of mathematical modeling in application transformation matrix are determined by individual problems moving the piston, connecting rod and crankshaft [1].

### GENERAL MATRIX ROTATING OF TRANSFORMATION

The kinematics of mechanisms studied the geometry of its motion relative to the adopted fixed (absolute) coordinate system, without taking into account the forces and moments that cause the motion. Analysis of piston compressor is very complex and gives results strictly related to the specific geometry of the simulated machine. The purpose of this paper is to describe a simple model is easily adaptable to different piston mechanisms. Therefore, the general model of the compressor consists of several sub-models which are related to the different elements that influence its behavior [6], [7], [8]. Scheme of the system resulting from such categorization is presented in Figure 1.

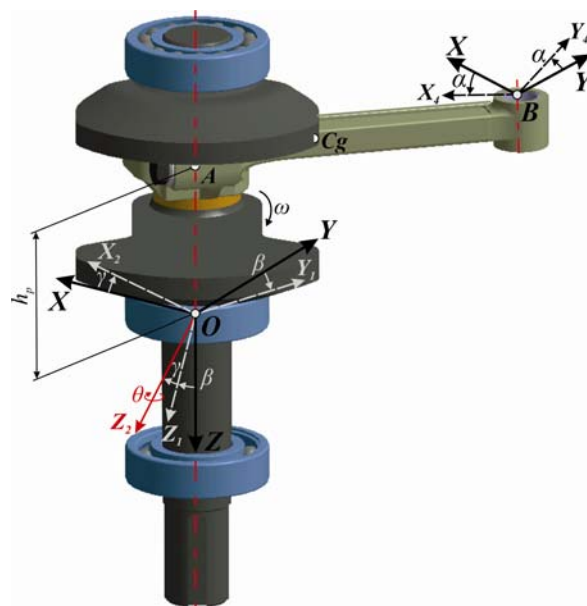




**Figure 1.** Components of the piston compressor

Components of a reciprocating compressor crankshaft and connecting rods are modeled as rigid bodies, piston displacement is modeled as a material point and the main shaft is modeled as an elastic body. To determine the kinetic characteristics of segments compressors it is necessary to know the number of segments, the coordinates of their centers of mass and how their mutual connection, it is of kinematic pairs-joints. As the basic kinematic variables analyzed issues of the position, velocity and acceleration segments mechanism. On the basis of this analysis, there is a closed condition vector outline, reflecting the geometric relationships of the movable joints segments. For example, to schedule a piston mechanism shown in Fig. 1 (crankshafts and connecting rods), defined to be stationary and moving coordinate systems.

To define a general matrix is necessary to observe the inertial reference coordinate system  $I_{XYZ}$  and identified four reference position system (Figure 2). Inertial reference coordinate system is set up for the center bearing (point  $A$ ), while the observed reference positions  $B_1$ ,  $B_2$  and  $B_3$  connected to the crankshaft and the moving reference system  $B_4$  is related to the piston rod. System  $B_1$  ( $X_1Y_1Z_1$ ) is obtained by rotating, the angle  $\beta$  about the axis  $X$ ; system  $B_2$  ( $X_2Y_2Z_2$ ) is obtained by rotating  $B_1$  angle  $\gamma$  around the axis  $Y_1$ ; system  $B_3$  ( $X_3Y_3Z_3$ ) is obtained by rotating the  $B_2$ , the angle  $\theta$  around the axis of  $Z_2$ , and system  $B_4$  ( $X_4Y_4Z_4$ ) is obtained by rotating and  $I$  angle  $\alpha$  around the  $Z$  axis, [2], [13].



**Figure 2.** Kinematic mechanism scheme and vectors

Where:

$I$ - refers to the observed position of the inertial reference system

$X, Y$  - refers to the  $X$  and  $Y$

$A, B, C$  - refer to points  $A, B, C$ , respectively

$B_i$  - refers to the  $i$ -drive system reference

$\omega$  - speed rotation of the crankshaft, [rad / s]

$\theta$  - angle of rotation of the knee on the  $Z$ - $Z$  axis [rad]

$\alpha$  - angle rotating rod, [rad]

$\beta$  - angle rotation around the  $X$ - $X$  axis [rad]

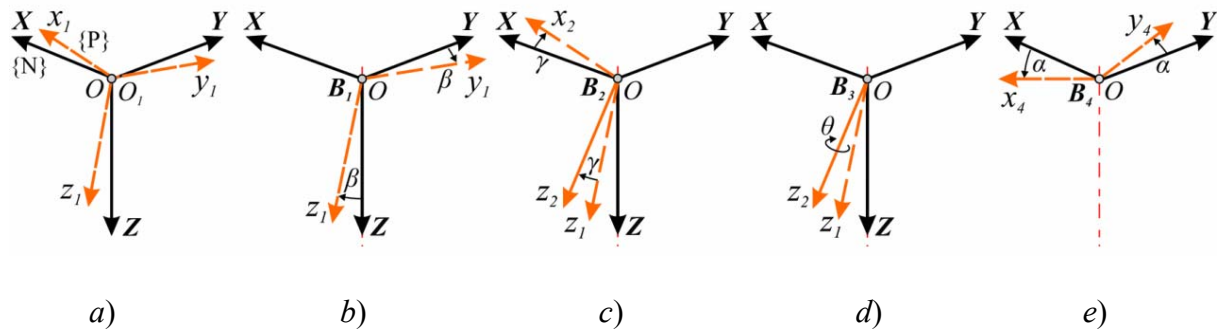
$\gamma$  - angle rotation around  $Y_1$   $Y_1$ -axis [rad]

$\varphi$  - angle position [rad].

Transformation matrix moving coordinate system, relative to fixed, determined by taking into account the possible movements of the segments with respect to one another, that is types of kinematic pairs of entering given segment (taking into account the mobility of the kinematic pairs). Thus, the appearance of each matrix is determined by the choice of the coordinate system, placing and mutual orientation of the axes in space, so that a selected axis can be changed in further analyzes and transformations.

Discuss some features of the matrix form of records in the process of converting vector coordinates given in different coordinate systems. Some were given two rectangular coordinate systems with a common beginning [09], [10].

In reciprocating mechanisms are often moving segments drawn so that their rotation is not performed simultaneously around all three axes. More often, these developments made gradually, and some structural mechanisms kinematic couples allow one or two rotation. Therefore, the practical importance of a rotation matrix with respect to a separate axis. Figure 3 presents the coordinate systems that are capable of uniaxial rotation around the  $x$  axis by angle  $\beta$ ,  $y$  axis by angle  $\gamma$ ,  $z$  axis and the angle  $\theta$ . Then we get the rotational transformation matrix.



**Figure 3.** The uniaxial rotation of the coordinate system: a) Immovable {N} and moving {P} coordinate system, b), c), d), e) rotation about the axis of the fixed angle

Transformation matrix are determined using the equation:

Transformation matrix of the inertial coordinate system  $I$  the drive moving system for the case  $B_1$  rotation around  $Ox$ -axis for angle  $\beta$ , as shown in Fig. 3 has the form:

$$T_{\beta} = \begin{bmatrix} 1 & 0 & 0 \\ 0 & \cos \beta & \sin \beta \\ 0 & -\sin \beta & \cos \beta \end{bmatrix} \quad {}^N T_{B_1}(x; \beta) = \begin{bmatrix} 1 & 0 & 0 \\ 0 & \cos \beta & \sin \beta \\ 0 & -\sin \beta & \cos \beta \end{bmatrix} \quad (1)$$

The transformation matrix of a stationary inertial coordinate system into a mobile system  $B_1$  to  $B_2$  for the case of rotation about  $Oy$ -axis for angle  $\gamma$ , as shown in Fig. 3 has the form:

$$T_\gamma = \begin{bmatrix} \cos \gamma & 0 & -\sin \gamma \\ 0 & 1 & 0 \\ \sin \gamma & 0 & \cos \gamma \end{bmatrix} \quad {}^{B_1}T_{B_2}(y; \gamma) = \begin{bmatrix} \cos \gamma & 0 & -\sin \gamma \\ 0 & 1 & 0 \\ \sin \gamma & 0 & \cos \gamma \end{bmatrix} \quad (2)$$

The transformation matrix of a stationary coordinate system  $B_2$  a mobile system for case  $B_3$  rotation around the  $Oz$  - axis by angle  $\theta$ , as shown in Fig. 3 has the form:

$$T_\theta = \begin{bmatrix} \cos \theta & \sin \theta & 0 \\ -\sin \theta & \cos \theta & 0 \\ 0 & 0 & 0 \end{bmatrix} \quad {}^{B_2}T_{B_3}(z; \theta) = \begin{bmatrix} \cos \theta & \sin \theta & 0 \\ -\sin \theta & \cos \theta & 0 \\ 0 & 0 & 0 \end{bmatrix} \quad (3)$$

The transformation matrix of the inertial coordinate system moving system  $B_4$  for the case of rotation around  $Ox$ -axis by angle  $\alpha$ , as shown in Fig. 3 has the form:

$$T_\alpha = \begin{bmatrix} \cos \alpha & -\sin \alpha & 0 \\ \sin \alpha & \cos \alpha & 0 \\ 0 & 0 & 1 \end{bmatrix} \quad {}^N T_{B_4}(x; \alpha) = \begin{bmatrix} \cos \alpha & -\sin \alpha & 0 \\ \sin \alpha & \cos \alpha & 0 \\ 0 & 0 & 1 \end{bmatrix} \quad (4)$$

Rotational transformation matrix around the axis of the  $B_1$  to  $N$ ,  $B_2$  to  $B_1$ ,  $B_3$  to  $B_2$ ,  $B_4$  in  $N$ , according to Figure 2, written in the form:

$$\begin{aligned} {}^N T_{B_1}(x; \beta) &= [{}^{B_1} T_N]_{(x; \beta)}^T, \quad {}^{B_1} T_{B_2}(y; \gamma) = [{}^{B_2} T_{B_1}]_{(y; \gamma)}^T \\ {}^{B_2} T_{B_3}(z; \theta) &= [{}^{B_3} T_{B_2}]_{(z; \theta)}^T, \quad {}^N T_{B_4}(x; \alpha) = [{}^{B_4} T_N]_{(x; \alpha)}^T \end{aligned} \quad (5)$$

where the sign  $[ ]^T$  denotes matrix transposition.

Rotational transformation matrix given (1) - (4) are a rotational transformation matrix. For the case when the segments between two segments allow two or three rotations, then the total rotational transformation matrix can be obtained by multiplying the elementary matrix in a specific order.

### Determining the position vector and the equations connections

Equations connections are established in only one case that has accentuated the work. In Fig. 2 shows the vector diagram that illustrates how they relate to the main parts of the system considered. Equation connections and the position vector for analysis of crankshaft and connecting rods is obtained from equation (6), [2], [3], [11], [12], [13], [14].

Figure 4 is a schematic representation of the mechanism with the parameters required for the calculation of the other components.

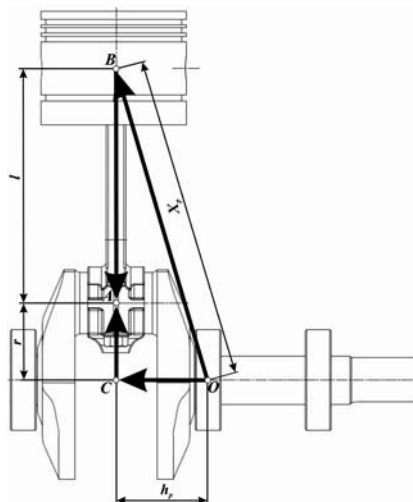


Figure 4. Kinematic mechanism with rotating segments

**Case I:** Ignoring the lateral displacements and crankshaft angle oscillation is given by:

$${}_I \mathbf{x}_p + {}_I \mathbf{l} = {}_I \mathbf{r} \quad (6)$$

where,

$${}_I \mathbf{r} = \mathbf{T}_{\theta}^T \cdot {}_{B_3} \mathbf{r}; \quad {}_{B_3} \mathbf{r} = \{r_c \quad 0 \quad -h_p\}^T; \quad {}_I \mathbf{l} = \{-l \cos \alpha \quad l \sin \alpha \quad 0\}^T; \quad {}_I \mathbf{x}_p = \{x_B \quad 0 \quad -h_p\}^T$$

$h_p$  - the length of crankshaft rotation, [mm].

$l$  - length of the connecting rod, [mm],

$r$  - radius, [mm],

$I$  - relative to the inertial reference frame XYZ

$I$  - moment of inertia tensor.

### Kinematic relations determining the velocity and acceleration

Angular velocity of each of the moving reference system can be written as in Equation (7).

$$I \dot{\boldsymbol{\beta}} = \{\dot{\beta} \quad 0 \quad 0\}^T; \quad B_1 \dot{\boldsymbol{\gamma}} = \{0 \quad \dot{\gamma} \quad 0\}^T; \quad B_2 \dot{\boldsymbol{\theta}} = \{0 \quad 0 \quad \dot{\theta}\}^T; \quad I \dot{\boldsymbol{\alpha}} = \{0 \quad 0 \quad -\dot{\alpha}\}^T \quad (7)$$

For a given case, the absolute angular velocity of the crankshaft is derived from  $\boldsymbol{\omega} = \dot{\boldsymbol{\theta}}$ , since the  $\dot{\boldsymbol{\beta}}$  and  $\dot{\boldsymbol{\gamma}}$  equal to zero. Thus, in these cases the moving reference frame  $B_3$  will be simply obtained by rotating  $I$ , the angle  $\theta$ , around the Z axis.

Expressions for calculating the velocity and acceleration of piston compressors ( $\dot{\mathbf{x}}_B, \ddot{\mathbf{x}}_B$ ) and connecting rod compressors ( $\dot{\boldsymbol{\alpha}}, \ddot{\boldsymbol{\alpha}}$ ) is obtained by differentiating the equation connections in each case respectively, Equations (8-9), [1], [2], [12].

Velocity:

$$\begin{pmatrix} \dot{x}_B \\ \dot{y}_B \\ \dot{z}_B \end{pmatrix} = \begin{pmatrix} l \sin \alpha \dot{\boldsymbol{\alpha}} \\ l \cos \alpha \dot{\boldsymbol{\alpha}} \\ r_c \dot{\boldsymbol{\theta}} \sin \theta \\ r_c \dot{\boldsymbol{\theta}} \cos \theta \end{pmatrix} \quad (8)$$

Accelerations:

$$\begin{pmatrix} \ddot{x}_B \\ \ddot{y}_B \\ \ddot{z}_B \end{pmatrix} = \begin{pmatrix} r_c (\ddot{\theta} \sin \theta - \dot{\theta}^2 \cos \theta) - l \dot{\alpha}^2 \cos \alpha \\ r_c (\ddot{\theta} \cos \theta - \dot{\theta}^2 \sin \theta) + l \dot{\alpha}^2 \sin \alpha \end{pmatrix} \quad (9)$$

Equations of motion of the crankshaft and connecting rod compressors for the case is obtained from Equation (10-14). As the piston is not subject to the current analysis, it should be noted that the friction forces are not included in the modeling of the piston, [3], [12], [14].

*Compressor crankshaft:*

- The equation of force crankshaft

$$\Sigma {}_I \mathbf{f} = m_C \cdot {}_I \bar{\mathbf{a}}_C \Rightarrow {}_I \mathbf{f}_A = m_C \{\ddot{x}_C, \ddot{y}_C, 0\}^T \quad (10)$$

- Moment of crankshaft

$$\Sigma {}_{B_3} \mathbf{M}_C = {}_{B_3} \mathbf{r} \times {}_{B_3} \mathbf{f}_A + {}_{B_3} \boldsymbol{\tau} = {}_{B_3} \mathbf{I}_C \cdot \frac{d}{{dt}} ({}_{B_3} \boldsymbol{\omega}) + {}_{B_3} \boldsymbol{\omega} \times ({}_{B_3} \mathbf{I}_C \cdot {}_{B_3} \boldsymbol{\omega}) + m_C \cdot {}_{B_3} \bar{\mathbf{r}}_{C-cm} \times {}_{B_3} \mathbf{a}_C \quad (11)$$

where,

$${}_{B_3} \mathbf{f}_A = \mathbf{T}_{\theta} \cdot \mathbf{T}_{\gamma} \cdot \mathbf{T}_{\beta} \cdot {}_I \mathbf{f}_A; \quad {}_{B_3} \boldsymbol{\tau} = \{0, 0, t_z\}^T; \quad {}_{B_3} \bar{\mathbf{r}}_{C-cm} = \{e_c, 0, 0\}^T$$

*Compressor piston rod:*

- Compulsory equations of force connecting rod

$$\Sigma {}_I \mathbf{f} = m_{cr} \cdot {}_I \bar{\mathbf{a}}_{cr} = {}_I \mathbf{f}_A + {}_I \mathbf{f}_B \quad (12)$$

where,

$${}_I \bar{\mathbf{a}}_{cr} = {}_I \mathbf{a}_B + {}_I \dot{\boldsymbol{\alpha}} \times {}_I \dot{\boldsymbol{\alpha}} \times {}_I \bar{\mathbf{r}}_{cr} + {}_I \ddot{\boldsymbol{\alpha}} \times {}_I \bar{\mathbf{r}}_{cr} = \begin{Bmatrix} \ddot{x}_B + \bar{r}_{cr} (\dot{\alpha}^2 \cos \alpha + \ddot{\alpha} \sin \alpha) \\ \bar{r}_{cr} (\ddot{\alpha}) \cos \alpha - \dot{\alpha}^2 \sin \alpha \\ 0 \end{Bmatrix};$$

- A torque connecting rod equation

$$\Sigma {}_{B_4} \mathbf{M}_B = {}_{B_4} \mathbf{l} \times {}_{B_4} \mathbf{f}_A = {}_{B_4} \mathbf{I}_{cr} \cdot \frac{d}{{dt}} ({}_{B_4} \dot{\boldsymbol{\alpha}}) + {}_{B_4} \dot{\boldsymbol{\alpha}} \times ({}_{B_4} \mathbf{I}_{cr} \cdot {}_{B_4} \dot{\boldsymbol{\alpha}}) + m_{cr} \cdot {}_{B_4} \bar{\mathbf{r}}_{cr} \times {}_{B_4} \mathbf{a}_B \quad (13)$$

where:

$${}_{B_4} \mathbf{f}_A = \mathbf{T}_\alpha \cdot {}_I \mathbf{f}_A; \quad {}_{B_4} \mathbf{a}_B = \mathbf{T}_\alpha \cdot {}_I \mathbf{a}_B; \quad {}_I \mathbf{a}_B = \{\ddot{x}_B, 0, 0\}^T$$

Equation of piston:

- Forced piston equation

$$\Sigma {}_I \mathbf{f}_B = m_p \cdot {}_I \mathbf{a}_B = {}_I \mathbf{f}_B + {}_I \mathbf{f}_N + {}_I \mathbf{f}_P \quad (14)$$

where:

$${}_I \mathbf{f}_P = \{P_g A_p, 0, 0\}^T.$$

In each case the equation of motion can be written in matrix form as in Equation (15), where vector  $\bar{\mathbf{b}}$  contains the main unknown (that is. Reaction force, torque and acceleration response).

Where:

$$\bar{\mathbf{b}} = \{f_{B_x}, f_{B_y}, f_{B_z}, N_y, N_z, f_{A_x}, f_{A_y}, f_{A_z}, f_{C_z}, \ddot{\theta}, \ddot{x}_B, \ddot{\alpha}, \ddot{x}_C, \ddot{j}_C\}^T. \quad (15)$$

For each case the equations of motion may be written in a matrix form as in Eq. (16), where the vector  $\bar{\mathbf{b}}$  contains the main unknowns (i.e., reaction forces, reaction moments and accelerations).

$$\bar{\mathbf{A}} \cdot \bar{\mathbf{b}} = \bar{\mathbf{c}} \quad (16)$$

## RESULTS AND DISCUSSION

Equations 1-4 show the matrix is  $3 \times 3$  and the interconnection between the three variables. Calculation of the correlation matrix is the initial step in any factor analysis. It is obtained by matrix product more compact standardized data matrix. Its elements include cosines of angles between all possible elements within a standardized column vectors. It is possible to display the geometric relationships between the vectors whose the cosine correlation presented. For example, in Equation 1-4 show the three vectors corresponding correlation matrix. Vectors of species data matrices are stored in three-dimensional space, based on equations representing the segment specific application presented model and Matlab software.

A simple review of the real mechanism that serves as the basis for calculating the kinematic scheme. Kinematic scheme piston mechanism, made from actual mechanism. This paper presents a general model of a reciprocating compressor with a cylinder that is used in the industry. This describes the basic approach and the advantages and disadvantages of the presented solutions. The results can be compared, if they used the same input parameters [16].

## CONCLUSION

To determine the kinetic characteristics of piston mechanism with rotating joints very successfully be used rotational transformation matrix whose theoretical basis and method of calculation presented in this paper. Included in the calculation of the position of certain characteristic points, velocity and acceleration. The above calculation methodology is suitable for computer use, because the kinematic calculations amount to solving matrix equations. The convenience of these equations is that it is propelled movement of the internal structure can be assigned in any form, which enables the use of a realistic model of the motion segment of kinematic chain, ie. complete model of engine.

## REFERENCES

- [1] Mikić, D., Ašonja, A., Solving inverse kinematics without applying the matrix rotation, 10<sup>th</sup> International Conference "Research and Development in Mechanical Industry" RaDMI 2010, Vol. I, pp. 644-650, 16 - 19. September 2010, Donji Milanovac, Serbia.
- [2] Mikić D., Desnica, E., Aleksandar, A., Adamović, Ž., The Mechanical modeling of industrial machines, II International Conference – Industrial Engineering And Environmental Protection (IIZS 2012), Zrenjanin, october 2012.
- [3] Edgar A. Estupiñan, Ilmar F. Santos, Technical University of Denmark, Department of Mechanical Engineering, Nils Koppels Allé, Building 404, DK-2800, Kgs. Lyngby, Denmark.
- [4] Orest Fabris, Mirko Grljušić, Kompresori, Sveučilište u Splitu, Fakultet elektrotehnike, strojarstva i brodogradnje u Splitu, Split, 2010.
- [5] Mikić, D., Ašonja, A., Gligorić, R., Savin, L., Tomić, M. (2012). Dynamic Solving of Rotational Transformation Matrix Using the D'ALAMBER Principle, TTEM - Technics Technologies Education Management, Vol.7, No.3, pp.1187-1195.
- [6] Corberán, J. M., J. González, A Global Model for Piston Compressors with Gas Dynamics Calculation in the Pipes, International Compressor Engineering Conference, Purdue University, USA, 1998, pp. 851–856.
- [7] Pérez-Segarra, C. D., F. Escanes, A. Oliva, Numerical Study of the Thermal and Fluid-Dynamic Behaviour of Reciprocating Compressors, International Compressor Engineering Conference, Purdue University, USA, 1994, pp. 143–150.
- [8] Escanes, F., C. D. Pérez-Segarra, J. Rigola, J. M. Serra, J. Pons, M. Escribà, M. Jornet, Numerical Simulation of Hermetic Reciprocating Compressors. Recent Improvements and Experimental Validation, International Compressor Engineering Conference, Purdue University, USA, 1996, pp. 193–198.
- [9] Ašonja, A., Mikić, D.: The Economic justification of substitution of conventional method of lubrication with systems for automatic lubrication, 10<sup>th</sup> International Conference "Research and Development in Mechanical Industry" RaDMI 2010, Vol. 2, p. 1005-1010, 16 - 19. September 2010, Donji Milanovac, Serbia.
- [10] Ašonja, A., Mikić, D., Stojanović, B., Gligorić, R., Savin, L., Tomić, M. Examination of Motor-Oils in Exploitation at Agricultural Tractors in Process of Basic Treatment of Plot, Journal of the Balkan Tribological Association, Vol.19, No.2, pp.230-238, 2013.
- [11] Kim, T. J. and Han, J. S., 2004, "Comparison of the Dynamic Behavior and Lubrication Characteristics of a Reciprocating Compressor Crankshaft in Both Finite and Short Bearing Models", Tribology Transactions, Vol.47, No.1, pp. 61-69.
- [12] Golubović, D., Mikić, D., Milićević, I.: Kinematika robota sa korišćenjem matrica rotacionih transformacija, Zbornik radova sa naučno-stručnog skupa, Istraživanje i razvoj mašinskih elemenata i sistema IRMES'04, UDK 621.01 (082), st.147-153, ISBN 86-80581-66-6, COBISS.SR-ID 116409868, 2004. Kragujevac.
- [13] Dufour, R., Der Hagopian, J. and Lalanne, M., 1995, "Transient and Steady State Dynamic Behaviour of Single Cylinder Compressors: Prediction and Experiments", Journal of Sound and Vibration, Vol.181, pp. 23-41.
- [14] P. R. G. Kurka1, Karen L. G. Paulino2, Jaime H. Izuka, Dynamic Modeling of Reciprocating Compressors with Vertical Axis, 1Faculty of Mechanical Engineering, University of Campinas (UNICAMP) P.O. Box 6122, 13083-970 Campinas, SP, Brazil, 2010.
- [15] Subramanian K., Subramanian L. R. G., Joseph B., Jayaraman: Mathematical Modeling and Simulation of Reciprocating Compressors – A Review V. of Literature, Mathematics Modelling and Applied Computing, Volume 1, Number 1 (2010), p.p. 81–96, 2010.
- [16] Desnica, E., Letić, D., Gligorić, R., Primena CAD alata u projektovanju i edukaciji - oblast podmazivanja, Časopis Traktori i pogonske mašine, vol.16, no.4, Novi Sad, 2011, str. 103-109.

## DYNAMIC UPS SYSTEM

**Branislav Todorović, John Olukoyi**

JTI International AD Senta, Serbia

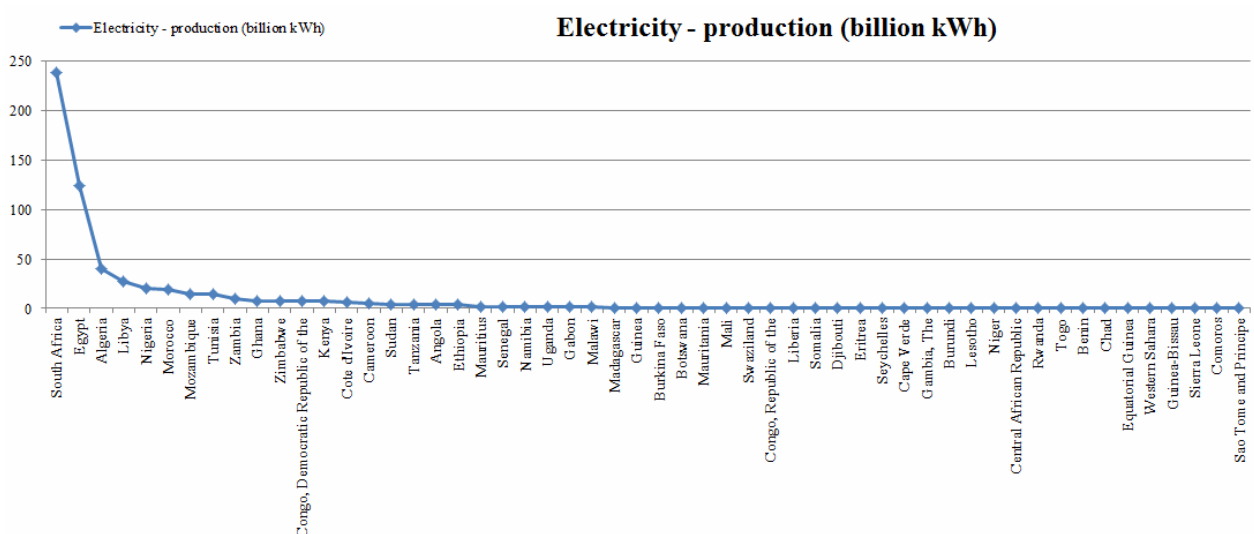
e-mail: [brantod29@gmail.com](mailto:brantod29@gmail.com), [engrolukoyi@yahoo.com](mailto:engrolukoyi@yahoo.com)

**Abstract:** This work will present the installation of an industrial UPS system, latest generation, in order to fully neutralize the problems related to irregular supply of electricity and all other incidental negative effects on one manufacturing facility in West Africa. This is a project, whose implementation is currently in progress, will also present data showing the complexity of the environment faced by large businesses in this part of the world. The functioning of the dynamic UPS system will be presented with the envisaged modes of operation.

**Key words:** UPS system, power failure.

### INTRODUCTION - FACTS AND FIGURES

There is no question that electricity in Africa is inaccessible and unaffordable to most people. Even for the wealthy, the limited supply makes its availability unreliable with frequent power outages. Of the 1.2 billion world citizens who live in the dark, around 550 million live in Africa [1]. Power failures are a regular scene in cities, towns and villages across Africa with attendant negative impact on the quality of living and business productivity. Power plants and transmission lines across Africa, most of which were erected in the 1950s and 1960s, operate today at just a fraction of installed capacity due to insufficient maintenance and lack of modernization. Countries with gas/diesel/coal fired power plants often find themselves with no electricity whenever there is disruption in supply of these fossil fuels due to either high cost or production disruption. Nigeria for example, has a number of newly built gas fired power plants which are not producing electricity yet because Nigeria, an exporter of gas and crude, is yet to supply gas or diesel to these plants. In Algeria, gas pipeline network from Algeria to Europe guarantees natural gas supply to Europe, while urban population and rural residents alike suffer scarcity of cooking gas because domestic distribution is not developed [2]. The complexity of the situation is best seen from the data on electricity production in all countries on the African continent. Presented data is for the year 2012. (Fig. 1) This shows that 44.4% of the countries on the African continent do not have its own electricity production or it is negligible. On the other hand, among the countries that have the capacity to produce electric energy differences are large. As an example South Africa, whose electricity production is greater than the total production of all other African countries with the exception of Egypt.



**Figure 1.** Electricity production in Africa – year 2012.

## RENEWABLE ENERGY

The United Nations report launched on March 12 this year says that hydropower could supply all of Africa's electricity needs if cross-border cooperation was stepped up. Africa currently generates just one third of its electricity from hydropower, but could learn from cooperation and training programs with India and some Western countries. Some African governments, according to the report, have begun to recognize the importance of cooperative electricity projects. Several strong examples have begun to emerge, including the Southern African Power Pool (SAPP) and the West African Power Pool. These bring together groups of national electricity companies under the authority of the Southern African Development Community and the Economic Community of West African States respectively. Unfortunately financial challenges of finding the money for dam and hydropower plants were significant and can be a huge obstacle in the future [3].

## POWER SUPPLY INFRASTRUCTURE

There are many international initiatives to start solving the problem of electricity supply in the countries on the African continent, but unfortunately the realization of these projects has so far only on paper. The unstable political situation in most African countries deters potential investors who might use their knowledge and technology to improve electricity production. Across the continent, wars and militancy have left power plants and distribution infrastructure disrupted, damaged or destroyed. For example, Sierra Leone's Bumbuna hydroelectric project was nearly complete when civil war disrupted construction. Most of Liberia's energy power plants and transmission lines were so damaged or destroyed during its long civil war that the national electricity company estimates it will cost more than \$107 million and take several years to achieve restoration to the level they were before the war. The situation is similar in Angola and Mozambique [2].

It is well known that the business interests often can be a strong driving force to solve various technological problems. Large business entities (corporations) in some cases when they do not get the expected support from the host government try to solve the problem on their own, as in the case of the implementation of this project.

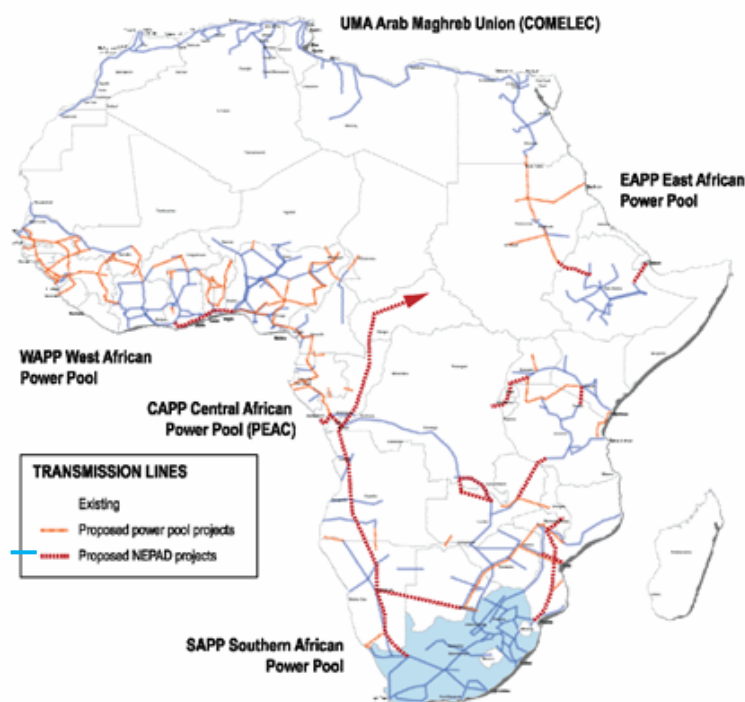


Figure 2. Electricity transmission lines in Africa



## THE REASONS FOR THE INSTALLATION OF UPS SYSTEMS

The observed location where the realization of the installation project of the UPS system is ongoing unfortunately shares the fate of the rest of the African continent in relation to the problems of the power supply. In addition to the frequent failure of power supply a further problem is the large mains voltage fluctuations, which are in the range of 352 to 421 VAC. As an example, we present data from August 2013th year (Fig. 3) which clearly shows how bad and unstable power supply can affect production.

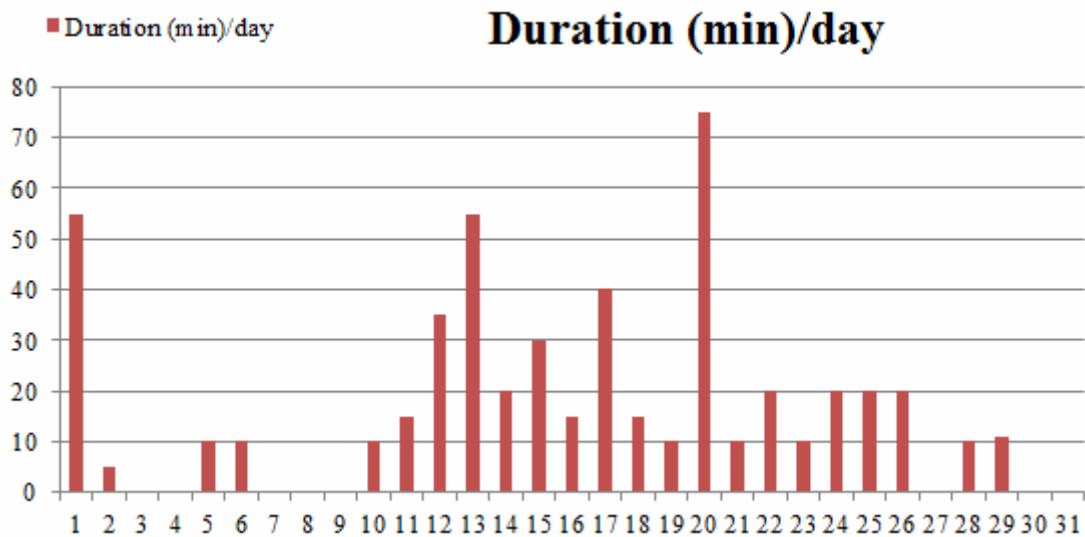


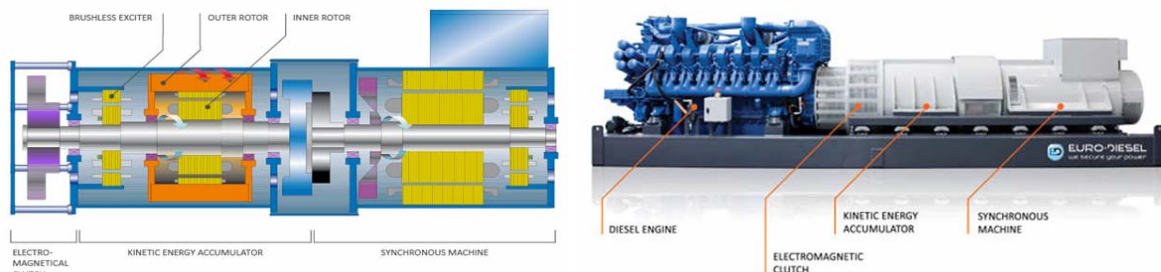
Figure 3. Power failure duration – August 2013.

Total lost time in production during the month of August amounted to 521 minutes. This is certainly a direct loss, but it also should be noted that associated problems and possible risks go hand in hand with the outage of power supply. All vital components, both mechanical and electrical, suffer enormous stress due to the failure of electricity supply. Besides the mechanical parts, especially at risk are electrical components such as programmable logic controllers, drives, servo drivers, industrial computers, process measurement equipment, etc... Unfortunately the network of modern equipment distributors for industrial automation and electronics is still underdeveloped in Africa. This means that in the event of failure of any of these components, there is a risk that the defective part will have to be ordered and its delivery will be a minimum of 6 to 8 weeks. Some technological processes require continuity which certainly cannot be achieved under these conditions. This results in high costs from the losses of discarded materials. All these difficulties led the management of the factory to implement a UPS system urgently. In this sense, the best solution proved to be the UPS system.

### Solution

The main idea of this project is to connect all manufacturing facilities on the dynamic UPS system with power of 1500 kVA. Why is this UPS system so powerful? In the heart of the NO-BREAK KS® [6], is its kinetic energy accumulator, a clever but simple system to store and retrieve kinetic energy. The kinetic energy accumulator consists of two rotating parts: the outer rotor runs mechanically-free around the inner rotor. The inner rotor, driven by the main shaft, rotates at 1500 rpm (50 Hz) or 1800 rpm (60 Hz). It contains two sets of windings: a three-phase AC winding and a DC winding. In conditioning mode, the AC winding is powered to generate a rotating magnetic field which turns the outer rotor to the speed of maximum 3000 rpm. However, the relative speed between inner and outer ring of the bearings is only 1500 rpm, since the shaft itself is rotating at 1500 rpm.

The outer rotor stores kinetic energy advantageously, since the amount of kinetic energy increases quadratically with the distance from the center of rotation. In independent mode, the DC winding is powered and the outer rotor is electrically coupled to the inner rotor by induction. Its kinetic energy is transferred to the inner rotor, and so drives it. This energy transfer is regulated by accurately controlling the current injected into the DC winding. The kinetic energy accumulator is a totally brushless system.

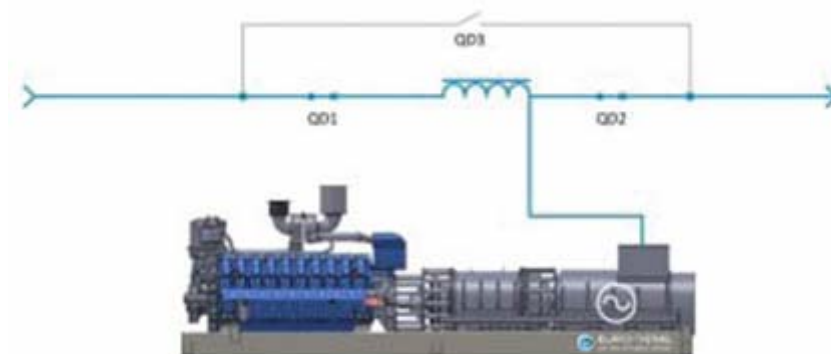


**Figure 4.** NO-BREAK KS® Dynamic UPS system

The main advantages of this solution are: reliability, monobloc unit, unique system (completely free of rings and brushes), absolute guarantee that the diesel engine will start (using the kinetic energy of the accumulator should the conventional starting system fail), accumulation of kinetic energy before returning to normal service (this allows successive power supply failures to be handled), bearing replacement every 10 years, life of No-Break KS® System of at least 20 years, a single unit to handle both types of load: critical and essential, service production able to cope with long term power supply failures, efficiency up to 96,4 % under full load which minimizes operating costs, small size and may be installed in an area without air conditioning and without anti-acid treatment, electrical control panel composed mainly of simple components, harmonic filtration and acceptance of deforming loads, elimination of micro-failures during normal operation, voltage stabilization at the terminals for the load, immune to up-line and down-line perturbations such as: short-circuits voltage spikes due to lightning strikes of operator error calls for current, automatic supply of reactive power, guaranteeing a power factor close to unity up line of the No-Break KS® installation, operation and maintenance can be carried out by a technician without any special training.

### Operation description

In conditioning mode (Fig. 5) [6], when the mains supply is within tolerance ( $\pm 10\%$  of the nominal), the synchronous machine is acting as a motor, driving the main shaft and thus the accumulator, storing kinetic energy in it. When the inner rotor rotates at 1500 rpm (50 Hz) or 1800 rpm (60 Hz), the outer rotor then rotates at maximum 3000 rpm. The kinetic energy is thus stored. 99% of the time or more, the NO-BREAK KS® operates in conditioning mode and guarantees the supply of a clean electrical, and conditioned power to the load.



**Figure 5.** Conditioning Mode

In independent mode (Fig. 6) [6] during mains failure or voltage perturbation--the stored kinetic energy is now transferred to the stato-alternator, which acts as a generator. This happens without any interruption to the user. Shortly after, the diesel engine starts and couples to the stato-alternator by latching the electromagnetic clutch. The energy is then relayed from the diesel engine to the synchronous machine and then to the loads. Sequence is as follows:

- QD1 opens
- The kinetic energy transferred from the outer rotor maintains the frequency at 50 Hz or 60 Hz within +/- 1%
- The engine starts
- The electromagnetic clutch closes
- When the engine reaches 1500rpm (1800 rpm for 60 Hz), it transfers power to the load, until the mains supply returns.

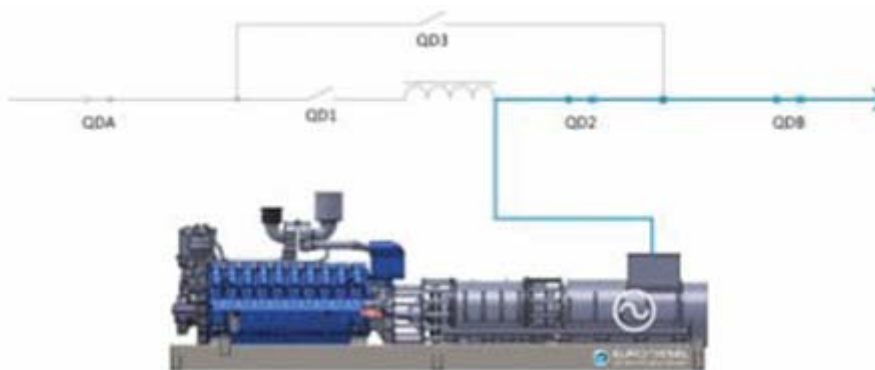


Figure 6. Independent Mode

#### Transfer from conditioning mode to independent mode and vice versa

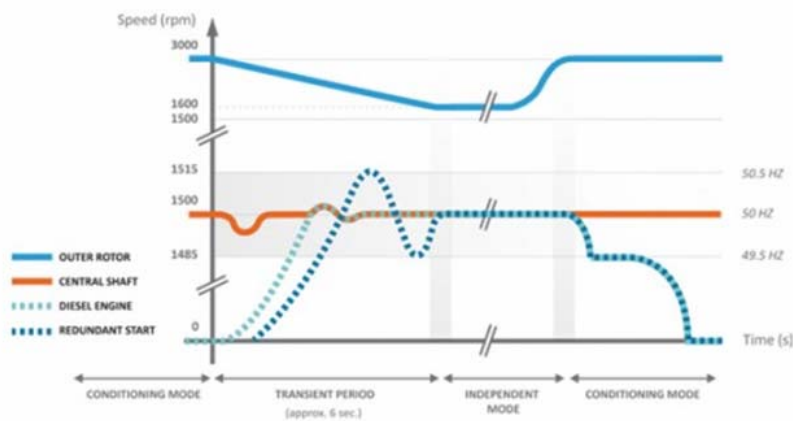


Figure 7. Transfer modes

Graph (Fig. 7) shows the transfer from conditioning to independent mode and back: The frequency is maintained within narrow tolerances, the accumulator's speed decreases and then the diesel engine starts to provide power to the load. In the event of a diesel engine start-up failure, the electromechanical clutch will close shortly after opening QD1 and the kinetic energy of the accumulator will start the diesel engine. This gives the NO-BREAK KS® a redundant start possibility; a second guarantee to start the engine. When mains supply return sequence is as follows:

- The NO-BREAK KS®, synchronizes with the mains supply.
- The outer rotor is re-accelerated to its rated speed.
- When the rated kinetic energy is stored, QD1 closes.
- The electromagnetic clutch opens.
- The diesel engine runs at idle speed for cooling and then stops eventually.

## CONCLUSION

Africa's power requirements continue to expand with the rapid growth and development throughout the continent driving the need for more widespread and reliable electricity. An example like this is described and presented in this work also contributes to improving the supply of electricity, but it is not enough. According to the international agencies in addressing the issues of quality of electricity supply in Africa is doing very little. Although able to make independent decisions about their energy destiny, thanks to their governments Africa still live in the dark. Some companies who choose to do business on the African continent will certainly continue to try independently to solve the problem of their own electricity supply, but it will not help to improve the overall situation from the perspective of the population. African governments need to find strategic partners who have the technology and knowledge and who are able to turn the African continent from energy mouse into an energy giant. The truth is that this is possible!

## REFERENCES

- [1] <http://soundcloud.com/primediabroadcasting/20130705africareport>
- [2] [http://www.desertec-africa.org/index.php?option=com\\_content&view=article&id=29:africas-electricity-infrastructures-are-either-dilapidated-or-nonexistent&catid=2:africas-energy-situation&Itemid=2](http://www.desertec-africa.org/index.php?option=com_content&view=article&id=29:africas-electricity-infrastructures-are-either-dilapidated-or-nonexistent&catid=2:africas-energy-situation&Itemid=2)
- [3] <http://www.unesco.org/new/en/natural-sciences/environment/water/wwap/wwdr/wwdr4-2012/>
- [4] <http://www.worldcoal.org/resources/ecoal-archive/ecoal-current-issue/energy-poverty-in-southern-africa/>
- [5] MEMO / Electrical supply options – Mr. Alex Barrow
- [6] <http://www.euro-diesel.com/english/operation-description/94/2>

## VARIABLE FREQUENCY DRIVE MOTOR CONTROL VIA CANOPEN PROTOCOL IN LABORATORY ENVIRONMENT

Miloš Božič, Srećko Ćurčić, Miloš Trifunović

University of Kragujevac, Faculty of technical sciences, Čačak, Serbia

e-mail: srecko.curcic@ftn.kg.ac.rs

**Abstract:** This paper will show the use of industrial frequency inverters for laboratory purposes. It will be shown using the CANopen communication protocol versus standard wiring and control via logic and analog inputs and outputs. Variable frequency drive is controlled by a programmable logic controller in accordance with standard 61131. It will be also given review of the functional blocks that can be used to control the motor via the drive over the CANopen network.

**Key words:** variable frequency drive; programmable logic controller, CANopen

### INTRODUCTION

Variable frequency drive (VFD) is a device that controls the speed of rotation of standard induction motor. In order to control and regulate the operation of motor, desired speed or torque is achieved via reference input signal. Reference input signal can be required from network or local via analog input. Modern drives can be completely automated, working on the industrial network. It is easy to connect drive to a PC, they are programmable, offer many functions for control and protection of motors. They are capable to measure, monitor and save the motor parameters. [1]

Usage of variable frequency drives not only facilitate the motor control, it is also keeps the human environment from pollution. Lower electrical power consumption is decrease emission of CO<sub>2</sub>. There is no need for gears; also there is less need for lubrication. With lower speed of motor there is less audible noise. Using communication protocols (like CANopen) instead classical wire control there is less need for cables and wires, because all control goes throw two wires.


**Table 1. The advantages of using the variable frequency drive**

<b>Energy saving</b>	Energy can be saved if the speed of the motor meets the requirements at any given moment loads. This applies primarily to drive pumps and fans which is proportional to the square of the energy expended speed. Drive that runs at half the speed of taking only 12.5% of the nominal power.
<b>Optimization of Process</b>	Adjusting the speed of the production process offers many advantages. This includes increasing production while reducing maintenance costs and material consumption and wear.
<b>"Soft" work of the machine</b>	Whit control of motor speed number of starting and stopping of the machine can be reduced. Using a soft start and soft stop ramps, stress, jerk and shock of machines can be avoided.
<b>Lower maintenance costs</b>	Variable frequency drives do not require maintenance. When used for motor control, drive life is increased. For example, in irrigation, there are water hammer phenomena, that depend directly on the pump. Whit usage of VFD this phenomena disappear, so there is no valves defects.
<b>Improved working environment</b>	Conveyor belt speeds can be set to exactly the required operating speed. For example, bottles on the filling line makes a lot less noise if the belt speed soft start and stop while filling..

## VARIABLE FREQUENCY DRIVE

Altivar 31 is a variable frequency drive manufactured by Telemecanique. It is designed to control the three-phase induction motor with power up to 1.5 kW (2 HP). The supply voltage is range from 380V to 500V and rated frequency is 50/60 Hz. [2]

**Table 1.** Basic parameters of variable frequency drive


 <p><b>Figure 1.</b> Variable frequency drive ATV31</p>	<b>Input parameters</b>	
	Maximal line current on 380V	6.4 A
	One second current	5 kA
	Apparent power	4.2 kVA
	Start current	10 A
	<b>Output parameters</b>	
	Nominal voltage	380 V
	Nominal current	4.1 A
	<b>Drive Interface</b>	
	Logical inputs	6 programmable inputs
	Analog inputs	3 of which two are voltage and one current
	Analog outputs	2 of which one is voltage and one current

## VARIABLE DRIVE TERMINALS

### Power terminals

The purpose of power terminals is for power supplying of drive and motor.

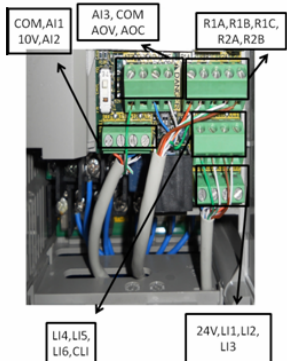
**Table 3.** Power terminals functions

 <p>↓ R/L1, S/L2</p> <p>↑</p> <p>↓ PO, PA/+, PB, PC/-, U/T1, V/T2, W/T3, ↓</p>	Terminal	Function
	↓	Ground
	R/L1, S/L2	Power supply
	P0	DC bus + polarity
	PA/+	Output to braking resistor
	PB	Output to braking resistor
	PC/-	DC bus - polarity
	U/T1, V/T2, W/T3	Outputs to the motor

### Control terminals

Variable frequency drive has two programmable relays, analog inputs and outputs. Analog inputs and outputs can be current type (0÷20mA) and voltage type (0÷10V).

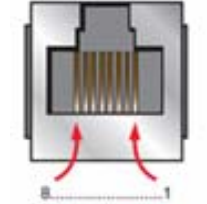
**Table 4.** Control terminals functions

	Terminal	Function	Terminal	Function
	R1A R1B R1C	R1 is a programmable relay, set as a fault relay. As a fault relay, R1A is closed and R1B is open when the controller is powered with no fault.	AI1, AI2	Analog voltage input
			AI3	Analog current input $X \div Y$ mA (0÷20 mA).
			AOV	Analog voltage output.
	R2A R2C	N.O. contact of programmable relay R2.	AOC	Analog current output
	10 V	Power supply for set point potentiometer 1 to 10 kΩ	24 V	Logic input power supply
	COM	Analog I/O common.	LI1 ÷ LI6	Logic inputs
CLI	Logic input common	RJ45	Communication connector.	

### Communication connector

Communication connector is dedicated for CANopen and Modbus communication. CANopen is a communication protocol and device profile specification for embedded systems used in automation. In the next table is shown connector RJ45 pin assignment.

**Table 5.** RJ45 connector pin assignment

RJ45 connector	Pin	Signal
	1	CAN H – High level signal CANopen
	2	CAN L – Low level signal CANopen
	3	CAN GND – Optional ground
	4	D1 – High signal Modbus
	5	D0 – Low level signal Modbus
	6	Not connected
	7	Power supply
	8	Common

### CANOPEN PROTOCOL

CANopen is a standardized protocol for distributed automation systems based on CAN (Controller Area Network) it offers the following performance features [3]:

- Transmission of time-critical process data according to the producer consumer principle
- Standardized device description (data, parameters, functions, programs) in the form of the so-called "object dictionary". Access to all "objects" of a device with standardized transmission protocol according to the client-server principle
- Standardized services for device monitoring (node guarding/heartbeat), error signalisation (emergency messages) and network coordination ("network management")
- Standardized system services for synchronous operations (synchronization message), central time stamp message
- Standardized help functions for configuring baud rate and device identification number via the bus
- Standardized assignment pattern for message identifiers for simple system configurations in the form of the so-called "predefined connection set"

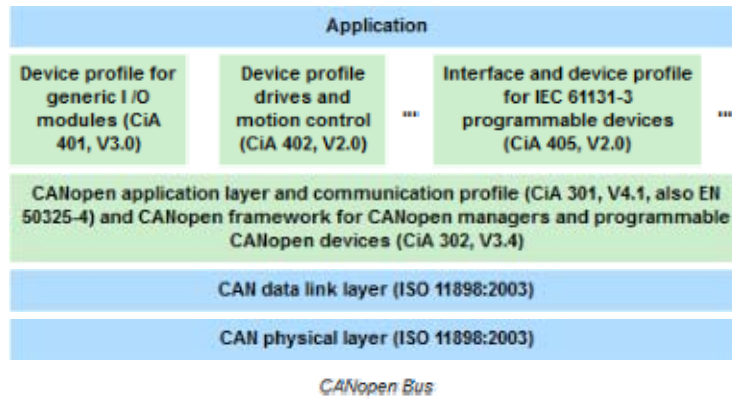


Figure 2. CANopen layer structure [4]

### Physical structure of a CANopen network

The underlying CAN architecture defines the basic physical structure of the CANopen network. Therefore, a line (bus) topology is used. To avoid reflections of the signals, both ends of the network must be terminated. In addition, the maximum permissible branch line lengths for connection of the individual network nodes must be observed.

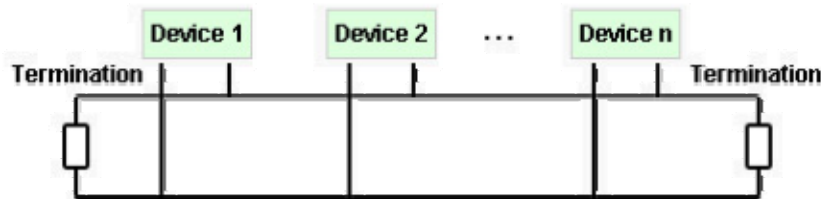


Figure 3. Physical structure of a network

The recommended permissible bit rates for a CANopen network are given in CiA 301: 10 kbps, 20 kbps, 50 kbps, 125 kbps, 250 kbps, 500 kbps, 800 kbps and 1000 kbps. In CiA 301 a recommendation for the configuration of the bit timing is also given. [5]

For CANopen, two conditions must be fulfilled:

- All nodes must be configured to the same bit rate and
- No node-ID may exist twice.

There are no mechanisms automatically ensuring these conditions. ID of every single network node must be adjusted if necessary.

### CONNECTION OF VFD AND PLC CONTROLLER WITH CANOPEN AND STANDARD WIRING

Programmable logic controller (PLC) used for this application is Schneider Electric Modicon M238. This controller offers high performance at low cost with efficient embedded features dedicated to simple axis motion control (high speed counting up to 100kHz, high speed pulse train and pulse width outputs). Embedded CANopen master allows easy and adaptable architectures for development flexibility. There are two serial lines for HMI connection or peripherals devices [6].



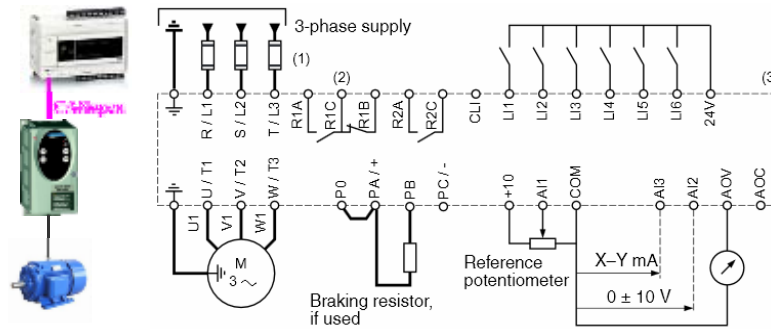


Figure 4. CANopen control vs standard wiring control

As it can be seen from picture, with control over CANopen network we need only two wires, but for standard control with logical and analog inputs and outputs we need much more wires than for CANopen control. Control over network is more flexible. There are a lot of variables that can be used over network. In next table you can see some portion of available variables, and its addresses on CANopen network.

Table 6. Communication variable [7]

CANopen address	Read/Write	Name
6046/1	R/W	Min. speed
6046/2	R/W	Max. Speed
6048/1	R/W	Acceleration – Speed delta
6048/2	R/W	Acceleration – Time delta
6049/1	R/W	Deceleration – Speed delta
6049/2	R/W	Deceleration – Time delta

### MOTION FUNCTION BLOCKS IN PLC FOR VFD CONTROL

Integrated in SoMachine programming software, the MFB (Motion Function Blocks) library has been enhanced to feature numerous independent axis functions for implementing motion control without the need for special modules or cards. MFB offer facilitates application programming, diagnostics and maintenance. It meets the simple axis control of any compact, modular or complex machines using PLC controllers in accordance with standard 61131 [8].

The below table shows which blocks are available on VFD ATV31:

Table 7. FB available for VFD

FB name	Available on ATV31
MC_ReadParameter	+
MC_WriteParameter	+
MC_ReadActualPosition	
MC_ReadActualVelocity	+
MC_Reset	+
MC_Stop	+
MC_Power	+
MC_MoveAbsolute	
MC_MoveRelative	
MC_MoveAdditive	
MC_MoveVelocity	+
MC_ReadAxisError	+
MC_ReadStatus	+
MC_Home	
MC_Jog	+

The blocks described in table 7 comply with the PLCOpen standard and the IEC61131-3 programming language standard [9]. The majority of blocks use the same input and output parameters, deemed basic. The operating principle of the basic input and output parameters is explained below.

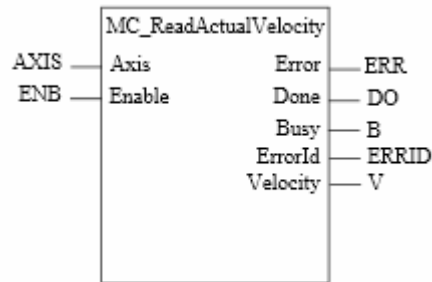


Figure 5. Example of MFB

## CONCLUSION

In this paper was presented a way of managing the work of the variable frequency drive using a programmable logic controller. It was presented a comparative view of control in the standard manner via the digital and analog inputs and outputs as well as control via the CANopen network. Advantages and possibilities of using control over communications were shown. Using the controller in accordance with standard 61131 enables using of simple control functional blocks. In addition, by using variable frequency drives there are various following benefits:

- Soft start and stop of the motor and controlled torque
- Easy controllable speed of the motor
- Protection and diagnostic of motor
- In some types of applications there is energy savings
- Easier configuration and programming process
- Improved working environment

## Acknowledgement

This paper presents the part of research conducted under the project III 42013 funded by Ministry of science and technological development of Republic of Serbia.

## REFERENCES

- [1] Laboratorijske vežbe iz regulacija elektromotornih pogona, Faculty of technical sciences Čačak, <http://www.empr.ftn.kg.ac.rs/regpog.html>
- [2] Variable frequency drive Altivar 31, manual, <http://www.schneider-electric.com/download/>
- [3] Olaf Pfeiffer, Andrew Ayre, Christian Keydel, Embedded networking with CAN and CANopen, Copperhill Technologies Corporation, 2008
- [4] CiA Draft Standard Proposal DSP-402, CANopen Device Profile for Drives and Motion Control, 1998
- [5] CAN in automation, CANopen, [www.csr-bessy.de](http://www.csr-bessy.de)
- [6] Logic controller modicon M238, manual, <http://www.schneider-electric.com/download/>
- [7] CANopen Implementation Altivar 312, manual, <http://www.schneider-electric.com/download/>
- [8] Standard SRPS EN 61131-3, <http://www.iss.rs/standard/?keywords=61131&Submit=>
- [9] Motion Control, PLCopen organization, [www.plcopen.org/](http://www.plcopen.org/)

## PARALLEL FLYING SHEAR

Miloš Božić, Srećko Ćurčić, Vladimir Vitezović

University of Kragujevac, Faculty of technical sciences, Čačak, Serbia

e-mail: srecko.curcic@ftn.kg.ac.rs

**Abstract:** The increasing need to save energy and minimize scrap together with requirements on the accuracy and quality of cutting operations in continuous industry lines have necessitated the development of the concept of flying shear control. This paper presents realization of one type of machine known as a parallel “flying shear”. Main components of the system are PLC controller, AC servo drive and variable frequency drive. Using this concept electrical energy can be saved, eliminating start - stop regime equipment life can be increased.

**Key words:** flying shear; PLC; variable frequency drive; servo drive

### INTRODUCTION

The flying shear is a common industrial application for cutting a product into smaller lengths, without stopping the line, this means that the main production process is not interrupted, and so machine's productivity is maximized. The cutting tool is typically mounted on a carriage that moves either parallel to the product flow or at an angle across the product flow. The flying shear drive accelerates the carriage to synchronize with the line speed. While they are synchronized the cut is done. After that the carriage decelerates and returns to start position ready to cut again. There are also many other similar applications where a carriage must be synchronized at line speed. The most of these applications can also be accommodated using the flying shear application software. [1]

This system has a number of advantages in terms of working conditions and safety at work. If we take into account that the system is fully automated cutting can be said that the participation of workers in this process is minimized. This fact alone shows that the risk of injury at work quite minimal because the employee does not need to have any physical involvement in the process, except for the initial setup before starting the machine and monitoring equipment at work. Using the power of the system and the drive (to be discussed) noise with the engine running is minimized because the speed control and synchronization is performed without mechanical transmission which produce large mechanical vibration and noise. [2]

### PARALLEL FLYING SHEAR CONCEPT

Linear flying shears are used in a variety of applications ranging from cutting material on the fly, filling bottles as they are moving on a conveyor. This particular overview describes the flying shear (cutting) application, but can be used for any process that requires speed matching to a given axis. This application controls the linear axis of the shear to ensure accurate cutting as well as a digital output for providing control of the cutting mechanism.

With parallel flying shears, the carriage travels in the same direction as the material. In the example shown below a shear is used to cut through a material, while the carriage and the material are synchronized. The shear would then be raised and would return to the start position ready to repeat the cycle. The parallel mode is best suited to applications where the tool operates instantaneously across the whole material width at the same time, such as a punch tool or a shear. [3]

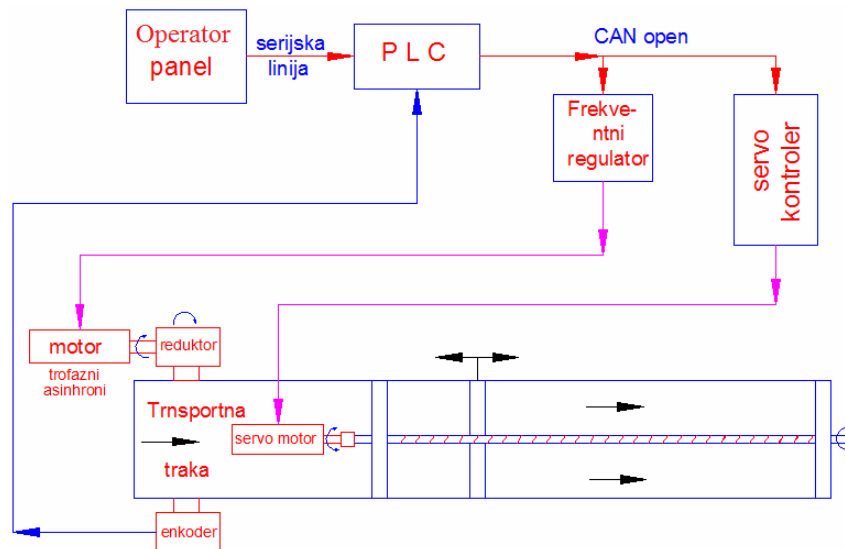


Figure. 1. Flying shear concept

## ALGORITHM

Algorithm for flying shear application can be divided into three steps.

1. Homing (Back to start position)
2. Synchronization
3. Specific operation (cutting, printing, gluing...)

Homing is process wherein the system is seeking for reference point or home. Homing can be done in many different ways, using the reference switch, using limits switches, with encoder, or with some mechanical barrier. When the system is referenced, next step in the algorithm can start.

Synchronization is process wherein linear axis with carriage is pretending to synchronize its moving with conveyor. When the speed of the carriage becomes equal to speed of conveyer, these two axes are synchronized. During synchronized moving some specific operation can be done. After specific operation is done carriage on linear axis go back to start position and wait for next move.

There are two different types of work regime of linear axis. It can be: continuous and discontinues. When carriage goes back to a start position also called wait position it is discontinues regime, and when there is no time for back to wait position it is continuous regime. [4]

## COMPONENTS OF THE SYSTEM

The main components of the system are presented on Figure 3:

1. Programmable logic controller
2. Servo drive
3. Variable frequency drive
4. Servo motor
5. Master encoder
6. Induction motor

### 1. Programmable logic controller

Programmable logic controller (PLC) used for this application is Schneider Electric Modicon M258. This controller offers high performance at low cost with efficient embedded features dedicated to simple axis motion control (high speed counting up to 100kHz, high speed pulse train and pulse width

outputs). Embedded CANopen master allows easy and adaptable architectures for development flexibility. There are two serial lines for HMI connection or peripherals devices [5].

## 2. Servo AC drive

Motion servo drive used for this application is Schneider Electric Lexium32M. This motion servo drive enables different work regimes: speed, position, torque and electronic gear. For a use in this application, servo is working in electronic gear regime. Electronic gear regime represents the operation in which two independent axes can be synchronized. The work way is based on getting impulses from the master encoder directly into a pulse train input (PTI) on motion servo drive. The basic thing which should be set is ratio between impulses from encoders. The purpose is to get good ratio between the speeds [6].

## 3. Variable frequency drives

Variable frequency drive (VFD) used for this application is Schneider Electric Altivar 312. This frequency drive represents standard industrial convertor. It has CANopen port, so the wiring is minimized. All commands and reference of speed are being setup throw CANopen communication [7].

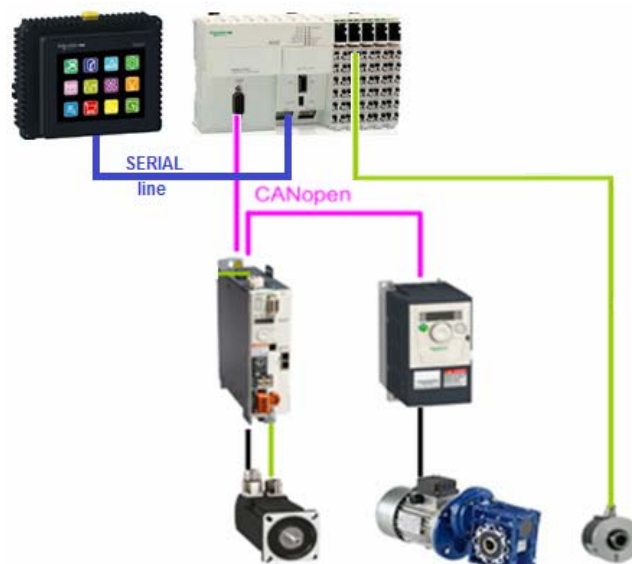


Figure. 2. Connection diagram

4. Servo motor is low-inertia AC synchronous servo motors designed for highly dynamic positioning tasks. A drive system consists of the servo motor and the appropriate drive. Maximum performance requires the motor and drive to be adapted to each other. Motor has SinCos encoder with resolution of 131071 inc/turn.

5. Master encoder is classical industrial incremental encoder with 1024 pulses per turn. He has two phases A and B. Based on the pulses number from encoder length of the cutting peace is tracked. Also, the instantaneous speed of line is calculated.

6. Induction motor is standard three phase industrial motor, which power is 180W, and speed 1420 rpm.

## PLC ALGORITHM

PLC controller used in this project is in according with standard 61131-3. The main part of algorithm is created using higher abstraction language sequential functional chart (SFC). Steps inside SFC

program are created using functional block diagram (FB). Using this type of programming created program looks like algorithm [8].

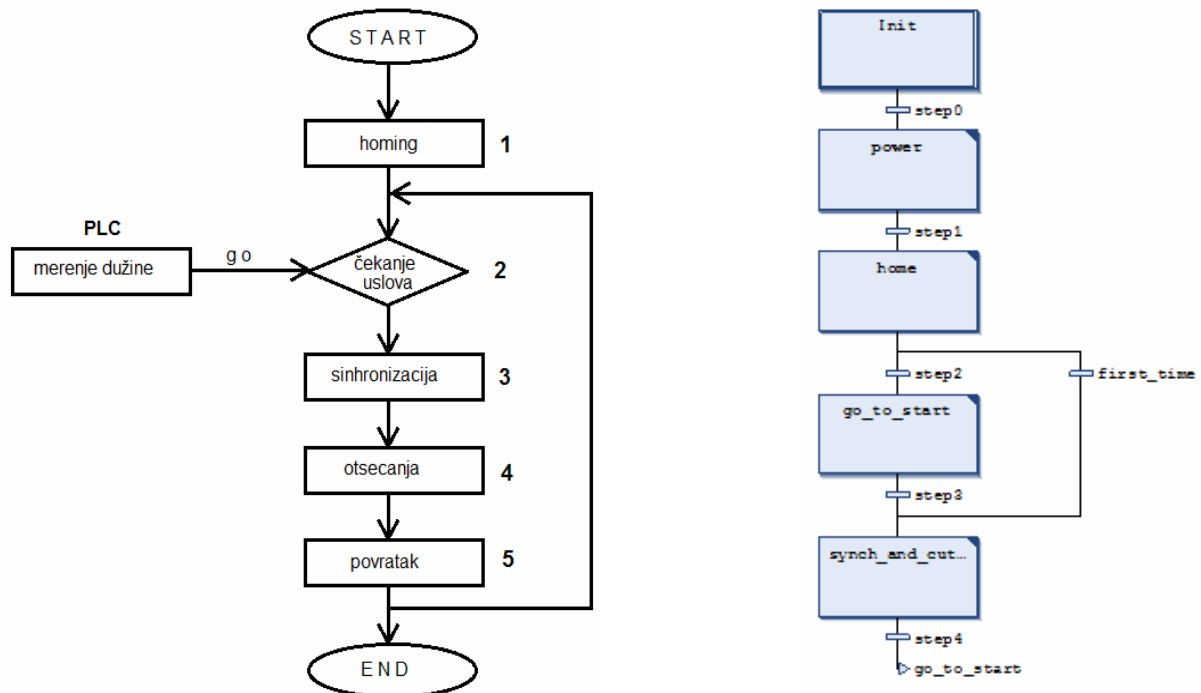


Figure 3. Algorithm and SFC program

In the SFC program next steps can be noticed:

**Init** – in this step the starting initialization of the system is done.

**Power** – during this step the energetic part of VFD and motion servo drive are enabled. Also, if there is a need for device resetting it can be done in this step.

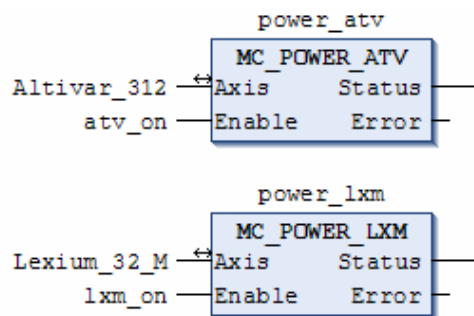


Figure 4. Powering VFD and motion servo drive

**Home** – this is the step in which system is seeking for reference – zero point. Method used for homing is method with limit switch without reference switch. During this operation linear axis is moving until stepping on the switch. In that moment linear axis is stopping and returns for couple encoders pulses. That is reference or home position. The next Figure 6 shows layout of function block for homing. As it can be seen on block the following parameters like: homing mode, homing speed, number of pulses for returning, has to be entered. [9]

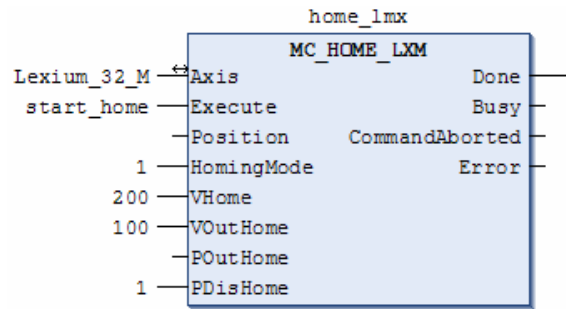


Figure 5. Function block for homing

**Synch\_and\_cutting** – in this step synchronization of axes is in progress. When the axes synchronization is done, specific operation during synchronized movement can be preceded. After the operation is done, axes are ending their work in synchronization and linear axis goes back to reference point. Function block for synchronization of axes is GearIn. This block needs parameters like numerator and denominator to be entered. And with them the ratio of speeds is achieved. Function block GearOut is used, for desynchronization.

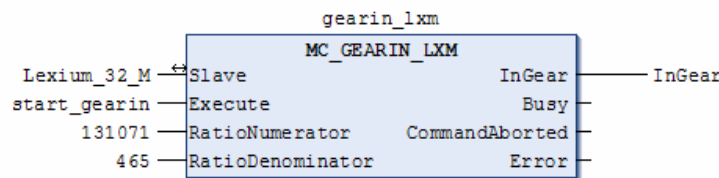


Figure 6. Function block GearIn

**Go\_to\_start** – during this step carriage returns to its start position. This step is very different from homing step. Reference point is known so there is no need to seek limit switch, and carriage is sent to start point with functional block MOVEABSOLUTE.

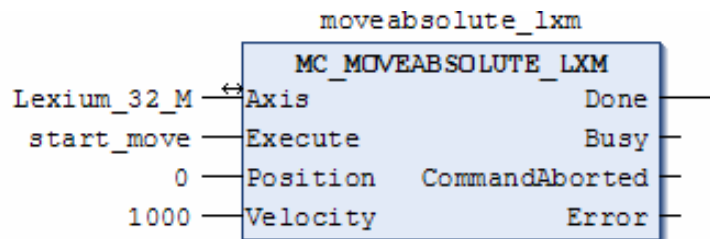


Figure 7. Function block move absolute

After return to start position, cycle start again from go\_to\_start point in program.

For this application, graphical user interface in Codesys visualization is also developed. In that way the user can enter parameters like speed of the line, length of the peace etc. Beside entered parameters user can monitor current values of variables like position of carriage, speed of line.

## CONCLUSION

In this paper is presented the realization of parallel flying shear application. Here is presented a simple application with standard PLC. More advanced applications require motion controller. By using the motion controllers possibilities are much higher. Function block like flying shear is also available. Using this type of system has next advantages:

- Multiple Cut Modes

Controller is able to accurately cut product for cut-to-length as well as cut-to-registration on the registration mark of the material.

- Matching Conveyor Speed

As product is being cut, speed matching is critical to prevent product damage and yield smooth, straight cuts.

- Increased throughput

Higher productivity should result from the addition of this motion control solution due to higher speeds and lower downtime

- Smooth Motion

The solution have smooth motion which reduce machine wear produced by jerky accelerations, resulting in increased machine life and lower maintenance (more uptime)

### **Acknowledgement**

This paper presents the part of research conducted under the project III 42013 funded by Ministry of science and technological development of Republic of Serbia.

### **REFERENCES**

- [1] Controller for Flying Operation (Flying Saws, Shears, Punchers etc.), Motrona GmbH, [http://www.motrona.com/cutter\\_control\\_1.html](http://www.motrona.com/cutter_control_1.html)
- [2] Linear flying shear Yaskawa, <http://www.yaskawa.com/site/industries.nsf/applicationDoc/appflyingshear.html>
- [3] Emerson Industrial automation, <http://www.emersonindustrial.com/en-EN/controltechniques/products/industrysolutions/flyingshear/Pages/flyingshear.aspx>
- [4] Baldor motion, <http://www.baldormotion.com/support/supportme/downloads/docslib/AN00116-003-%20Flying%20shear.pdf>
- [5] Logic controller modicon M238, manual, <http://www.schneider-electric.com/download/>
- [6] Motion servo drive Lexium32, manual, <http://www.schneider-electric.com/download/>
- [7] Variable frequency drive ATV312, manual, <http://www.schneider-electric.com/download/>
- [8] 3S-Smart Software Solutions, Codesys manual, [www.codesys.com/support-training/self-help/codesys-manual.html](http://www.codesys.com/support-training/self-help/codesys-manual.html)
- [9] Motion Control, PLCopen organization, [www.plcopen.org/](http://www.plcopen.org/)



## ELECTRIC CAR

Nikola Nikolić, Nenad Dajić

<sup>1</sup>University of Novi Sad, Technical Faculty “Mihajlo Pupin”, Zrenjanin  
e-mail: roker70@gmail.com

**Abstract:** The problem of this research is the development of electric cars, their energy efficiency, which will be showed in comparison of gasoline cars, hybrid cars, electric cars and hydrogen fuel-cell cars with an example of Tesla Roadster. The author’s idea of battery powered cars concept is also represented.

**Key words:** electric car, battery

### INTRODUCTION

The electric car, once the “zero-emissions” darling of environmentalists, is sometimes maligned as an “emissions-elsewhere” vehicle, since the electricity to charge its batteries must be generated in electrical generation plants that produce emissions. This is a reasonable point, but we must then ask how much pollution an electric car produces per mile – accounting for all emissions, starting from the gas or oil well where the source fuel is extracted, all the way to the final consumption of electricity by the car’s motor. When we work through the numbers, we find that the electric car is significantly more efficient and pollutes less than all alternatives. Fluid whose flow or speed is measured, can be gases, liquids or liquids mixed with solid ingredients. In the industry, converters and instruments to measure flow are often integral parts of the process controller or belong to systems for automatic control by computer. In the area of water supply (drinking water, irrigation, wastewater disposal ...), liquid or gaseous fuels, flow rate meters are essential parts of the meter, which is measured by the amount of fluid past. Given that it is about managing the demanding processing industry and/or collection of large sums of money, it is clear that the flow meters requires very high accuracy and reliability. [1]

### MATERIAL AND METHODS

#### Energy Efficiency

To compute the well-to-wheel energy efficiency of any car, we start with the energy content of the source fuel (e.g. coal, crude oil or natural gas) as it comes from the ground. We then track the energy content of this fuel as it is converted to its final fuel product (e.g. gasoline or electricity), subtracting the energy needed to transport the fuel to the car. Finally, we use the fuel efficiency of the car itself (e.g. its advertised mpg) to complete the equation.

All fuels can be described in terms of the energy per unit of mass. In this paper, we will express the energy content of fuels in terms of mega-joules per kilogram (MJ/kg). Well-to-wheel efficiency is then expressed in terms of kilometers driven per mega-joule (km/MJ) of source fuel consumed – a higher number is better.

#### Gasoline Cars

In this section, we will calculate the well-to-wheel energy efficiency of a normal gasoline-powered car. First, let’s take gasoline’s energy content, which is 46.7 MJ/kg [2], or 34.3 MJ/l [3]. Second, we know that production of the gas and its transportation to the gas station is on average 81.7% efficient [4], meaning that 18.3% of the energy content of the crude oil is lost to production and transportation. Third,  $34.3 \text{ MJ/l} / 81.7\% = 42 \text{ MJ/l}$ ; 42 mega-joules of crude oil are needed to produce one liter of gasoline at the gas pump.

The most efficient ordinary gasoline car made was the 1993 Honda Civic VX, which was EPA-rated at 51 mpg for combined city and highway driving [5]. Converting to metric, this car was rated at 21.7 kilometers per liter of gasoline. Thus, its efficiency is  $21.7 \text{ km/l} / 42 \text{ MJ/l} = 0.52 \text{ km/MJ}$ . Keep in mind that the Honda Civic VX got about twice the gas mileage of typical cars – a car like a Toyota Camry is rated around 0.28 km/MJ. [6]

### Hybrid Cars

All hybrid cars available today have no provision to charge their batteries except by using energy that is ultimately generated by their gasoline engines. This means that they may be considered, from a pollution and energy efficiency perspective, to be nothing more than somewhat more efficient gasoline cars. If the EPA-certified gas mileage for such a car is 51 mpg, this is exactly the same as an ordinary gasoline car that gets 51 mpg. (If a hybrid car could recharge its batteries by plugging in when at home, and if its batteries held enough charge for a meaningful drive, this would not be true.) The most efficient hybrid car is the 2005 Honda Insight, which gets 63 mpg for combined city and highway driving [7]. Using similar math as we used for the Civic VX above, the Insight's well-to-wheel energy efficiency is 0.64 km/MJ. The famous Toyota Prius is EPA-rated to get 55 mpg in combined city-highway driving, for an energy efficiency of 0.56 km/MJ. [8]

### Electric Cars

Even with tires and gearing optimized for performance (rather than absolute efficiency), the Tesla Roadster only consumes about 110 watt-hours (0.40 mega-joules) of electricity from the battery to drive a kilometer, or 2.53 km/MJ. [9]

The energy cycle (charging and then discharging) of the lithium-ion batteries in the Tesla Roadster is about 86% efficient. This means that for every 100 mega-joules of electricity used to charge such a battery, only 86 mega-joules of electricity are available from the battery to power the car's motor. Thus, the "electrical-outlet-to-wheel" energy efficiency of the Tesla Roadster is  $2.53 \text{ km/MJ} \times 86\% = 2.18 \text{ km/MJ}$ .

The most efficient way to produce electricity is with a "combined cycle" natural gas-fired electric generator. (A combined cycle generator combusts the gas in a high-efficiency gas turbine, and uses the waste heat of this turbine to make steam, which turns a second turbine – both turbines turning electric generators.) The best of these generators today is the General Electric "H-System" generator, which is 60% efficient [10], which means that 40% of the energy content of the natural gas is wasted in generation

Natural gas recovery is 97.5% efficient, and processing is also 97.5% efficient. [11] Electricity is then transported over the electric grid, which has an average efficiency of 92%, [12] giving us a "well-to-electric-outlet" efficiency of  $60\% \times 92\% \times 97.5\% \times 97.5\% = 52.5\%$ .

Taking into account the well-to-electric-outlet efficiency of electricity production and the electrical-outlet-to-wheel efficiency of the Tesla Roadster, the well-to-wheel energy efficiency of the Tesla Roadster is  $2.18 \text{ km/MJ} \times 52.5\% = 1.14 \text{ km/MJ}$ , or double the efficiency of the Toyota Prius.

### Hydrogen Fuel-Cell Cars

Hydrogen does not exist in nature except as part of more complex compounds such as natural gas (CH<sub>4</sub>) or water (H<sub>2</sub>O). The most efficient way to produce large quantities of hydrogen today is by reforming natural gas. For new plants, the well-to-tank efficiency of hydrogen produced from natural gas, including generation, transportation, compression, is estimated to be between 52% and 61% efficient. [13]

The upper limit of efficiency for a PEM (Proton Exchange Membrane) fuel cell is 50% [14]. The output of the fuel cell is electricity for turning a drive motor, and we can assume the same 2.53 km/MJ vehicle efficiency as with the electric car. With these numbers, we can calculate the well-to-wheel energy efficiency for our hydrogen fuel-cell car:  $2.53 \text{ km/MJ} \times 50\% \times 61\% = 0.77 \text{ km/MJ}$ .

This is impressive when compared to a gasoline car, though it is 32% worse than our electric car. But real fuel-cell cars do not perform nearly this well. Several car companies have produced a small number of demonstration fuel-cell cars, and the EPA has rated the efficiency of some of these. The best fuel-cell demonstration car measured by the EPA is the Honda FCX, which gets about 49 miles per kilogram of hydrogen, [15] equal to 80.5 kilometers per kilogram.

We know that the energy content of hydrogen is 141.9 MJ/kg, [16] so we can calculate the vehicle efficiency to be  $80.5 \text{ km/kg} / 141.9 \text{ MJ/kg} = 0.57 \text{ km/MJ}$ . (Clearly, the Honda fuel cell is nowhere near the theoretical 50% efficiency assumed above.) When we calculate the well-to-wheel energy efficiency of this Honda experimental car, we get  $0.57 \text{ km/MJ} \times 61\% = 0.35 \text{ km/MJ}$ , not even as good as the ordinary diesel Volkswagen Jetta, let alone the gasoline-powered Honda Civic VX or the Honda Insight hybrid car.

However, some proponents of hydrogen fuel cells argue that it would be better to produce hydrogen through electrolysis of water. The well-to-tank efficiency of hydrogen made through electrolysis is only about 22%, [17] and the well-to-wheel energy efficiency of our theoretical fuel-cell car would be  $2.53 \text{ km/MJ} \times 50\% \times 22\% = 0.28 \text{ km/MJ}$ , and the well-to-wheel energy efficiency of the Honda FCX would be  $0.57 \text{ km/MJ} \times 22\% = 0.12 \text{ km/MJ}$ , even less efficient than a Porsche Turbo.

Even with the \$1.2 billion U.S. government initiative to reduce U.S. dependence on foreign oil by developing hydrogen-powered fuel cells, a recent report by a panel at the National Academy of Sciences shows that Americans should not hold their breath waiting for the cars to arrive in showrooms. "In the best-case scenario, the transition to a hydrogen economy would take many decades, and any reductions in oil imports and carbon dioxide emissions are likely to be minor during the next 25 years," said the Academy. [18]

### Comparison

The following table shows the well-to-wheel energy efficiency of several types of high-efficiency cars – including an efficiency estimate of the Tesla Roadster – based on the measured performance prototypes. [1]

**Table 1.** Well-to-wheel energy efficiency of several types of high-efficiency cars

<b>Technology</b>	<b>Example Car</b>	<b>Source Fuel</b>	<b>Well-to-Station Efficiency</b>	<b>Vehicle Mileage</b>	<b>Vehicle Efficiency</b>	<b>Well-to-Wheel Efficiency</b>
Natural Gas Engine	Honda CNG	Natural Gas	86.0%	35 mpg	0.37 km/MJ	0.318 km/MJ
Hydrogen Fuel Cell	Honda FCX	Natural Gas	61.0%	64 m/kg	0.57 km/MJ	0.348 km/MJ
Diesel Engine	VW Jetta Diesel	Crude Oil	90.1%	50 mpg	0.53 km/MJ	0.478 km/MJ
Gasoline Engine	Honda Civic VX	Crude Oil	81.7%	51 mpg	0.63 km/MJ	0.515 km/MJ
Hybrid (Gas/Electric)	Toyota Prius	Crude Oil	81.7%	55 mpg	0.68 km/MJ	0.556 km/MJ
Electric	Tesla Roadster	Natural Gas	52.5%	110 Wh/km	2.18 km/MJ	1.145 km/MJ

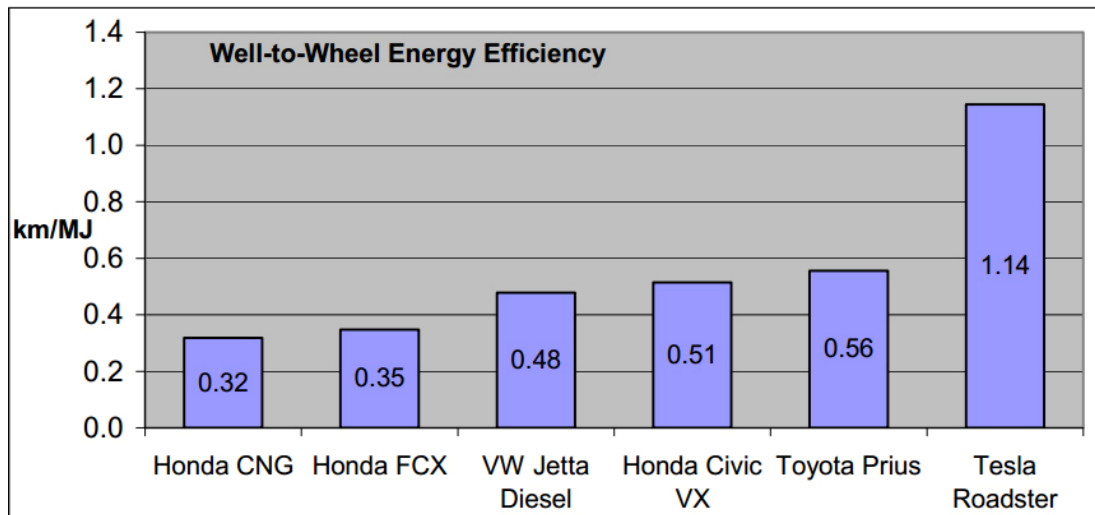


Figure 1. Well-to-wheel energy efficiency of several types of high-efficiency cars

### Author's idea of car batteries

I'm working on the standardization of batteries for electric cars:

Battery price is greater than half the price of a car, the charging process takes a long time, and driving radius is limited. Standardized batteries are universal (shape luggage, trays), all manufacturers use them, and the existing infrastructure of gas stations only need to add a "battery cells", which would be a "Green Ring". The idea is that as you buy a gas stove and rent a can (supplements), so to buy the electric car, and the state rent charge.

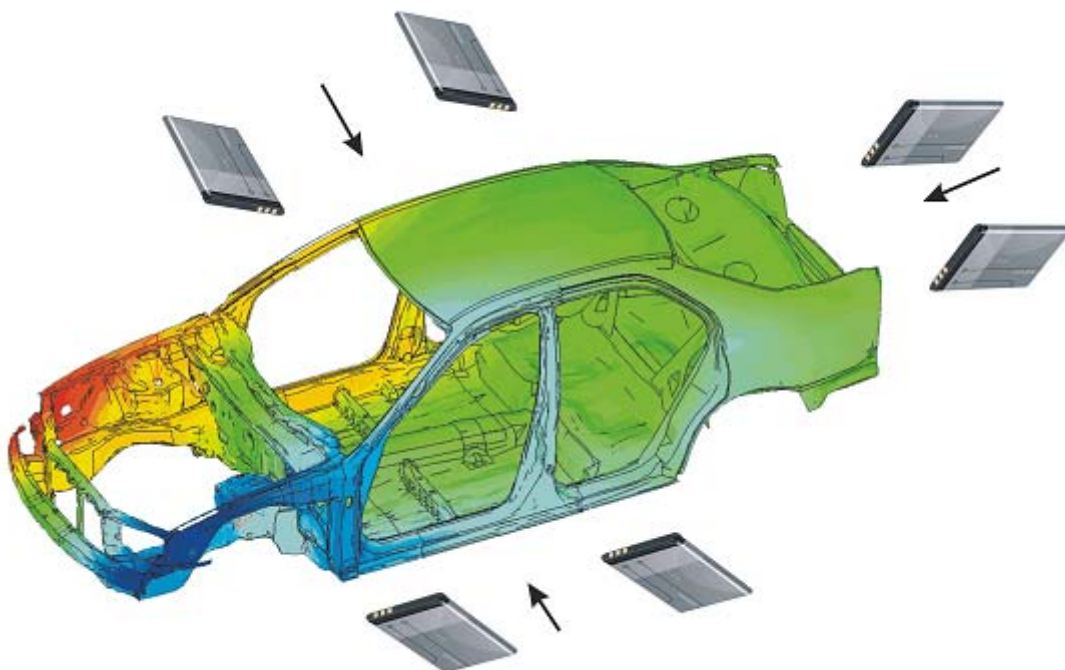


Figure 2. Location of car batteries

The proposal is that the batteries are the same voltage and amperage agreed. The physical dimensions would be such that they can be in the glove compartment, in the floor, the drive motors, and in the door there would be located battery supply box for other systems and lighting.

Of course, we're talking about the concept of electric garages, which would be distributed in a "rings" around the settlements, along the edges, the periphery.

Let me be clear: as purchased gas stove without bottle and a bottle is supplementing when it is empty, or in autogenous welding ... So the car would be a set of batteries required for normal operation of the car, and possibly another set, which would be filled in the electric garage somewhere in a ring around settlement.

## RESULTS AND DISCUSSION

The fundamental trade-off in convenience with electric cars is the advantage of starting every day with a "full tank" (and never visiting a gas station) versus inconvenient refueling on the road. While it is wonderful never to visit a gas station, this would be a bad trade-off if the driving range was too short.

The fundamental trade-off in convenience with electric cars is the advantage of starting every day with a "full tank" (and never visiting a gas station) versus inconvenient refueling on the road. While it is wonderful never to visit a gas station, this would be a bad trade-off if the driving range was too short.

Electric cars are mechanically much simpler than both gasoline cars and fuel-cell cars. There is no motor oil, no filters, no spark plugs and no oxygen sensors. The motor has one moving part, there is no clutch, and the transmission is much simpler. Due to regenerative braking, even the friction brakes will encounter little wear. The only service that a well-designed electric car will need for the first 100,000 miles is tire service and inspection [1]

## CONCLUSION

It is now possible build an exceedingly quick lithium-ion powered electric sports car that looks good, handles well, and is a joy to drive, at a lower price than most high-performance sports cars. And yet, this car will be the most fuel-efficient and least polluting car on the road. You can have it all.

## REFERENCES

- [1] Eberhard M., Tarpenning M., The 21st Century Electric Car, 2007.
- [2] Bossel U., Well-to-Wheel Studies, Heating Values, and the Energy Conservation Principle, 29 October 2003,
- [3] Glover T., Density of Gasoline from Pocket Ref, 3rd Edition, pp 660, 2002.
- [4] Exhaust Emissions From Natural Gas Vehicles by NyLund & Lawson, page 27, and also Well-to-Tank Energy Use and Greenhouse Gas Emissions of Transportation Fuels – North American Analysis, June 2001, by General Motors Corporation, Argonne National Laboratory, BP, ExxonMobil, and Shell. Vol. 3, Page 59
- [5] EPA mileage numbers from [www.fueleconomy.gov](http://www.fueleconomy.gov)
- [6] EPA mileage numbers from [www.fueleconomy.gov](http://www.fueleconomy.gov)
- [7] EPA mileage numbers from [www.fueleconomy.gov](http://www.fueleconomy.gov)
- [8] EPA mileage numbers from [www.fueleconomy.gov](http://www.fueleconomy.gov)
- [9] For comparison, the lead-acid based GM EV1 electric car was rated at 164 Wh/mile, or 102 Wh/km by the US DOE in their EVAmerica tests, formerly at <http://ev.inel.gov/fsev.shtml>.
- [10] General Electric "H System" Combined cycle generator, model MS7001H/9001H, as installed in Cardiff, Wales, in Tokyo, Japan, and in Scriba, New York.

- [11] Well-to-Tank Energy Use and Greenhouse Gas Emissions of Transportation Fuels – North American Analysis, by General Motors Corp., Argonne National Laboratory, BP, ExxonMobil, and Shell. Vol. 3, Page 42, June 2001.
- [12] 1 ibid, Page 33
- [13] Well-to-Tank Energy Use and Greenhouse Gas Emissions of Transportation Fuels – North American Analysis, June 2001, by General Motors Corporation, Argonne National Laboratory, BP, ExxonMobil, and Shell. Vol. 3, Page 59
- [14] Bossel U., Efficiency of Hydrogen Fuel Cell, Diesel-SOFC-Hybrid and Battery Electric Vehicles, 20 Oct 2003,
- [15] EPA mileage numbers from [www.fueleconomy.gov](http://www.fueleconomy.gov)
- [16] Bossel U., Well-to-Wheel Studies, Heating Values, and the Energy Conservation Principle, 29 October 2003.
- [17] Well-to-Tank Energy Use and Greenhouse Gas Emissions of Transportation Fuels – North American Analysis, June 2001, by General Motors Corp., Argonne National Laboratory, BP, ExxonMobil, and Shell. Vol. 3, Page 59
- [18] Reuters, Feb 4, 2004, 5:50 PM

## **SESSION 6: Basic operations, Machinery and Processes**

## TRAINING ARTIFICIAL NEURAL NETWORKS FOR DYNAMIC PROCESS MODELLING

**Jordan Badev, Ivan Maslinkov, Jeko Stoitchev, Plamena Madjarova**  
University of Food Technologies, Technical Faculty, Plovdiv, Bulgaria  
e-mail: [j\\_badev@abv.bg](mailto:j_badev@abv.bg)

**Abstract:** The present writing is concerned with improvement of the training of artificial neural network (ANN) for Dynamic Processes Modelling. Normally, as with the classical methods of identification, neural networks are trained only by step input and the respective response (object input-output). The quality of neural models with signals different from the step input is unsatisfactory. Here we present the results of a training employing both input signals of random type and amplitude, and their response. The results are approbated for linear discrete dynamic models.

**Key words:** Dynamic process Modelling, Recursive Perceptron, Auto Regressive eXternal input (ARX) Models. Training Artificial Neural Networks.

### INTRODUCTION

Neural algorithms are applied in various fields of science and engineering. They are typical with the following unique properties:

- A parallel structure composed of uniform logical units (neurons) arranged in layers, characterised by an algorithm “solidity” and the ability of generating output (solution) every time;
- Human-like training process, i.e. through multiple analysis (reviewing) of the images training set (TS), instead of comparing particular numbers;
- Retrieving and storing characteristics (properties) of the input data that is hard to be formalised, i.e. ability to summarise the input data and based on it, generate output;
- The capacity (the memory) of neural algorithms is determined by the underlying structure, also the contained quantity of neurons, and the quality of training;
- Possibility for actuating of linear and non-linear interdependence of the input and output values;
- Basically they are discrete algorithms but with sufficiently small intervals and fast processing of input data, their response may be considered uninterrupted;
- The flexible underlying structure possible to be made up of linear and non-linear neurons whose connections have different gravity (strength);
- When using this type of algorithms, two stages are clearly distinguished – setting up of the algorithm (training) and execution of the algorithm (simulation);
- For the numerical implementation significant computing resources are required, as well as unique software for the systems and devices;
- All these properties allow the numerous spheres of application, generally in processes and signals modelling, classification of massive data sets, prediction of values, events, etc. The most common applications fall into two trends – input data (images) classification and retrieval, and potentiality for retrieving and storing of information on the input data.
- When neural networks (NN) are used as models presenting the relation between the input and output values they do not supply any information about the model's underlying structure, i.e. they are to be seen as models of the black box type.

It is known and proven that the straight Multy Layer Perceptron (MLP) ANN of definite number of neurons in the hidden layers are universal approximators of static functions (models) [2].

What is challenging in this project is the setting up, simulation and studying of neural algorithms for dynamic processes modelling and identification. With dynamic processes the response depends not only on the current input values, but also on the preceding ones. Therefore, in dynamic processes modelling recursive structures should be applied [1], [3], [4]. The model dynamics may be realised employing delay connections (components) between the neurons in the different layers and in the feedbacks.



The aim of the study is to train the neural networks for modelling linear dynamic models of various types and parameters of input signals.

## MATERIAL AND METHODS

### Modelling of dynamic processes with artificial neural networks

Since the experimental data identification problems are discrete in their nature, herein discrete models and methods are studied.

If the discrete object input signal is  $u(k)$  and the discrete object response is  $y(k)$ , then the general equation that is the discrete image of the continuous differential equation may be presented as:

$$y(k) + a_1 * y(k-1) + a_2(k-2) + \dots + a_n y(k-n) = b_1 u(k-1) + b_2 u(k-2) + \dots + b_m u(k-m) \quad (1)$$

where  $n \geq m$ .

Without losing totality, studied here is the type where the values of  $u(k)$  and  $y(k)$  participate in a linear way, i.e. it is easy to model an expression with these values but of non-linear type. Often in identification these values are called regressors and they are assumed to be known values (measurable).

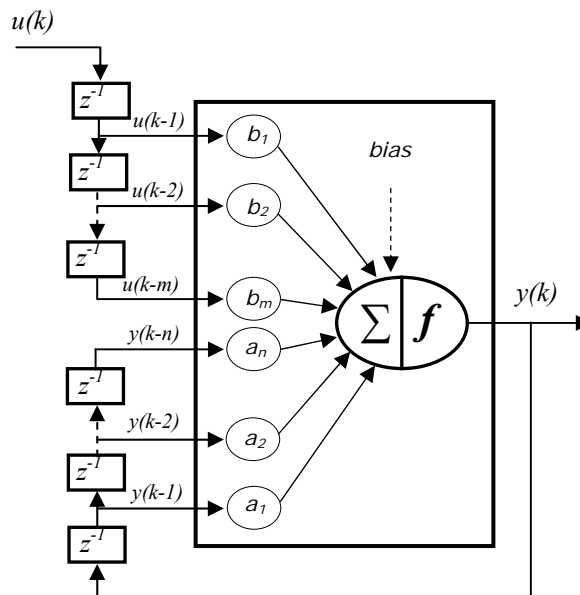
Finding of an object relevant model of the above type means to determine the coefficients  $[a_1, a_2, \dots, a_n, b_1, b_2, \dots, b_m]$  in equation.

$$y(k) = -a_1 * y(k-1) - a_2(k-2) - \dots - a_n y(k-n) + b_1 u(k-1) + b_2 u(k-2) + \dots + b_m u(k-m) \quad (2)$$

So that when calculating the response  $y(k)$  by the expression (model) above given, for  $k \geq n$ , the difference with the measured value  $y_0(k)$  to be minimal, i.e.

$$e(k) = y_0(k) - y(k) \approx 0 \quad (3)$$

That problem is easy to solve, provided that the necessary experiments are conducted with the object; it is far more difficult if the model is non-linear to the regressors.



**Figure 1.** Linear ARX model

The model type is determined by the ANN model and parameters, and by the input-output data for training.

The nature of dynamic models supposes the use of more complex than the straight NN structures,

namely the recurrent structures [2]. Characteristic of these structures is modelling of earlier (following) values of the quantities through unitary elements ( $z^{-1}$ ), for retaining the information in one stroke (discretization period -  $T_0$ ).

For example Eq.(2) could be presented with structure in Fig.1. Obviously the chart in the square is linear perceptron, that is a unitary structure building ANN. In this case it is evident that coefficients in Eq.(1) coincide with the connection weights at perceptron inputs, so it is natural that the process of finding the coefficients Eq.(2) be transformed into ANN training process.

With more complex equation the chart, shall contain a greater number of perceptrons (Fig.2). In this figure the blocks  $L_1$  perform respectively the functions  $f$  and generally can be implemented by a certain number perceptrons.

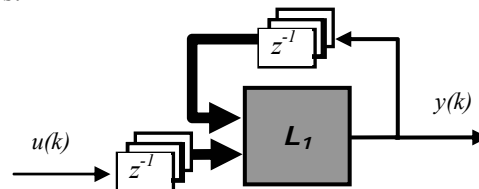


Figure 2. Neural ARX model.

If it is a linear object, then the perceptron activating function is linear too. Here the required computing capacity is minimal and the training process is the fastest. In many cases the non-linear models are modelled with non-linear neurons distributed in several layers, in a similar way.

## RESULTS AND DISCUSSION

The identification of actual physical objects is frequently done by experimental transient characteristics that contain the basic information of the static and dynamic properties, and therefore is used for objective evaluation of the control quality. The models are relevant if they produce one and the same response to various input signals. The validation of the neural model is through visual comparison between the model response and the neural model response.

In this writing, for better flexibility, it is being used data simulated with known discrete transfer function (TF) -  $W(z)$ .

In this writing, through ANN have been modelled TF of second order, object -Eq.(4) and third order oscillatory object – Eq.5.

$$W(z) = \frac{0.003121 * z^{-1} + 0.001 * z^{-2}}{1 - 1.01 * z^{-1} + 0.08208 * z^{-2}} \quad (4)$$

$$t(0)=0; t(end)=4 \text{ sec.}; T_0=0.05 \text{ sec.}$$

$$W(z) = \frac{0.0050 * z^{-1} + 0.0180 * z^{-2} + 0.0040 z^{-3}}{1 - 2.5842 * z^{-1} + 2.2571 * z^{-2} - 0.7692 z^{-3}} \quad (5)$$

$$t(0)=0; t(end)=80 \text{ sec.}; T_0=1 \text{ sec.}$$

For modelling the discrete TF (4) and (5) we have used networks of one linear neuron with respectively four and six input connections, and in both cases with one output connection, i.e. a size of NN is proportional to the model's order. The signals of the input connections, besides being “weighted” are also synchronously delayed in time by the discretization period. The input  $u(k)$ , and the output  $y(k)$  signals are sent to respective inputs of the neuron, as in the Fig.1.

For the NN training it is structured a training set (TS) composed of respective couples of signals – input Object Fig.3 and output (response) Object Fig.4. In the TS, input-output characteristics are used for three different types of inputs: step, ramp and sinusoidal - Fig. 3 and 4. Duration of processes is from 0 to 80 seconds.

For the training and testing of the neural models software under MATLAB<sup>®</sup> has been elaborated.

Training of neural models has been performed by classical method for ANN training. By the Levenberg-Marquardt method (trainlm), in all trials, the training lasted several (2-5) epochs, reaching mean square error (MSE) between the object outputs and the network within the order of  $5 \cdot 10^{-22}$ . The quality of the model has been tested through input signals different from those in the TS, yet of the same type, but with different amplitudes. In Fig. 5, 6, and 7 are the object response (resp...Obj) and the neural models response (resp...NN), for the step (step), ramp (lin), and sinusoidal (sin) inputs.

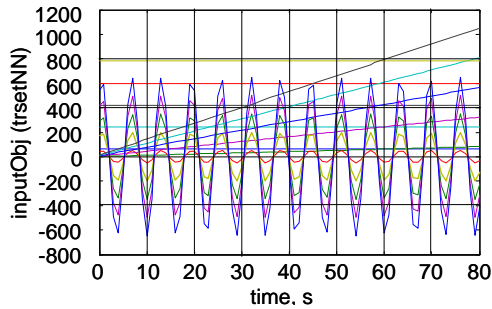


Figure 3. Input signals, for training NN

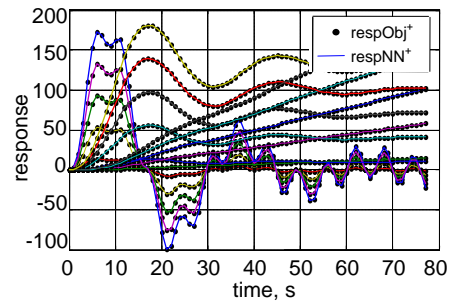


Figure 4. Response object, for training NN

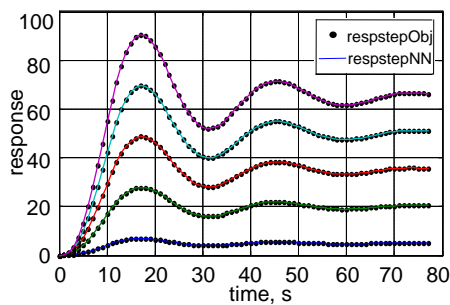


Figure 5. Step responses objects and NN

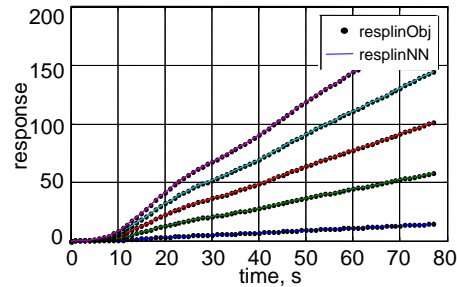


Figure 6. Ramp responses objects and NN

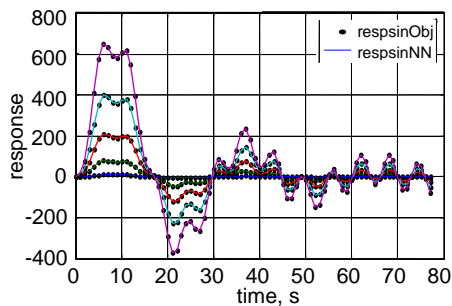


Figure 7. Sinusoidal responses objects and NN

At the end of the training, the reached values of the training parameters, like number of epochs, MSE, and the gradient mean value are displayed by the software, and here is a typical result:

**TRAINLM, Epoch 2/20, MSE 5.54301e-022/1e-010, Gradient 6.79432e-009/1e-010.**

In training by the classical methods, the connection weights to the input neuron of the already trained NN are at the same time coefficients in (5). The following results are obtained:

$$IL = [1 \dots -2.5843 \quad +2.2571 \quad -0.6592 \quad +0.0050 \quad +0.0180 \quad +0.0041].$$

Compared to the coefficients in (5), it is obvious that significant is only a deviation between the weight and the respective coefficient in front of  $z^{-3}$  in the denominator.

Simulated are also other dynamic neural models and objects of the same type, the results of which are omitted herein. It is proven that neural models constructed and trained with TS constructed in the same manner of input-output characteristics react in a relevant way to the respective objects with similar precision, and the weights and coefficients error is in the same order.

Tested have been neural models and response to input signals different in type from those of the TS (above) – exponential inputs signals, pulse signals in numerous levels, etc. For all trails conducted no significant differences between the response of the neural model and the simulated model have been observed.

## CONCLUSION

All results in Fig. 4, 5, 6 and 7 lead to the following major conclusions:

- Through recursive ANN of one linear neuron and number of weights equal to the coefficients in the ARX models, dynamic processes may be modelled with sufficient precision.
- The training set contains at the same time step, ramp, sinusoidal input signals and their respective responses of the object.
- For the training, the classical methods of training straight neural networks (back-propagation, Levenberg-Marquardt, etc) may be used.
- The discrete model coefficient is obtained as input connection weights to the neurons. The ANN training process may be also used for identifying ARX models as well other models that are linear in parameters.
- The training is fast, takes not more than several epochs, reaching network response and object response MSE within the order of  $<10^{-20}$ .

## REFERENCES

- [1] Badev J., Maslinkov I., Identification of Dynamic Processes with Artificial Neural Networks, ICEST 2013, Ohrid, Makedonia.
- [2] Hornik K., Stinchcombe M., Multilayer feedforward networks are universal approximators (Discussion paper 88-45), San Diego, CA, Department of economics, University of California, 1988.
- [3] Haykin S., Neural Networks (sec.edition), Prentice Hall, Pearson education, 1999.
- [4] Titova T., Nachev V., Damyanov Ch., Bozukov, N., Neuro-Genetic Algorithm for Non-Destructive Food Quality, ICEST 2013, Ohrid, Makedonia.

## MATHEMATICAL MODEL OF A ROLLING STAND

Novica Jevtić<sup>1</sup>, Ljubiša Josimović<sup>2</sup>, Momčilo Bjelica<sup>3</sup>

<sup>1</sup>Hidraulic, d.o.o., Smederevo, Serbia

Higher Business School of leskovac, Serbia

<sup>3</sup>University of Novi Sad, Technical Faculty "Mihajlo Pupin", Zrenjanin, Serbia

e-mail: [bjelica@tfzr.uns.ac.rs](mailto:bjelica@tfzr.uns.ac.rs)

**Abstract:** Mathematical model of rolling process is used at cold mill rolling on tandem mills in metallurgy. In this paper is present mathematical model of a rolling stand. It is present the rolling stands elastic deformation and plastic deformation curve.

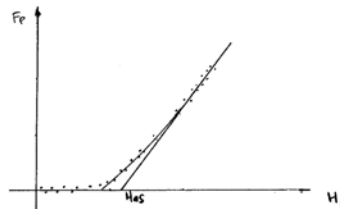
**Key words:** mathematical model, rolling stand, elastic deformation, plastic deformation

### INTRODUCTION

In hot and cold mill plants were mounted electrohydraulic servosystems for automatic gage control (instead electromechanic systems with screw thread) during modernisation. For the applications of the mostly control algorithms are necessary knowledge of mathematical models as components as complete object of automatic control. Detail analysis of these servosystems will help for better understanding and for the next optimisations by applications of modern control methods. This work is based on results from literature [1].

### ROLLING STANDS ELASTIC DEFORMATION AND PLASTIC DEFORMATION CURVE

Sum of elastic deformations of the all loaded rolling stand parts is rolling stand elastic deformation. Elastic deformation of rolling stand can be determined by theoretical or experimental method (theoretical method is rarely used because it is hard to determine the clearances between parts of rolling stand).



**Figure 1.** Curve of elastic deformation of the rolling stand

From the figure 1 is possible to write equation (1):

$$H_i = H_{os} + \frac{F_p}{E_s} \quad (1)$$

the following symbols are defined:

$H_i$  - strip thickness at the exit from the rolling stand,

$H_{os}$  - value of the initial gap between rolls,

$F_p$  - modulus of rolling stand elasticity.

Therefore equation (1) contains two unknown values (rolling force and thickness of the strip at the exit from the stand) it is necessary to know dependence of rolling force from exit strip thickness for a concrete rolling conditions (entry strip thickness, friction coefficient, rolls diameters...). Desired dependence is given by equation(2):

$$F_p = f(H_u, R, \lambda, \dots) \quad (2)$$

Curves given by equation (2) are strip plastic deformation curves (curves of plasticity and it is possible to obtain its by theoretical or experimental method. Figure 4 shows plastic deformation curve of strip.

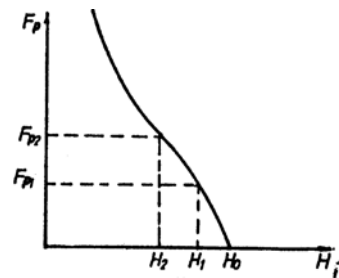


Figure 2. Plastic deformation curve of strip

From figure 2 it is obvious that greater rolling force enables smaller strip thickness at the rolling stand exit. Simultaneously equations (1) and (2) solving give rolling force and exit strip thickness during strip deformation in real working stand. Graphic equations solution is shown on figure 3.

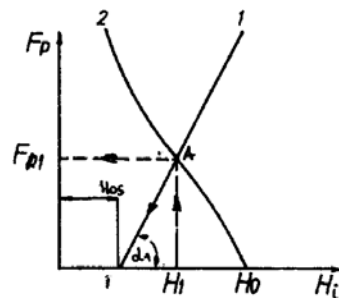


Figure 3. Graphic determination of the rolling force

Section n the straight line 1- the curve 2 determines point A. The coordinates of the point A ( $F_{p1}$  and  $H_1$ ) determine rolling force  $F_{p1}$  which must act on the rolls to perform exit strip thickness  $H_1$ . The gap between rolls increases from  $H_{os}$  to  $H_1$  until thickness of the strip reduced from  $H_{os}$  at entry of the stand to  $H_1$  at the exit of the stand. In the process computer are “memorized” straight line 1 and curve 2 and for demand  $H_1$  it is possible to determinate  $F_{p1}$  and  $H_{os}$  (it is necessary to draw a vertical line from the point  $H_1$  and point of section with the curve 2 is point A; From point A it is necessary to draw a horizontal line and obtain  $F_{p1}$ ; It is necessary to draw a line through a point A with angle  $\alpha$  and obtain  $H_{os}$ . However, if the strip has the greater hardness then the rolling force  $F_{p1}$  will not be sufficient to perform  $H_1$  and control system will increase the rolling force  $F_{p1}$  to get demand thickness of the strip at the exit of the stand.

## SERVOVALVE

Therefore a representation of servovalve response through the frequency range about 50 cps is sufficient (literature [1]), and a first-order expression is adequate. The time constant for the first-order transfer function is best established by 0.7 amplitude point (-3 db) (figure 4). Figure 6 shows a “Moog” servovalve dynamic response, together with the response of a first-order transfer function. The first-order approximation is a quite good through the lower frequency region. According to literature [2] and figure 4 we can write:

$$W_{sr} = \frac{1}{1 + T_1 S}$$

while:

$$T_1 = \frac{1}{2\pi\omega_1} \quad (3)$$

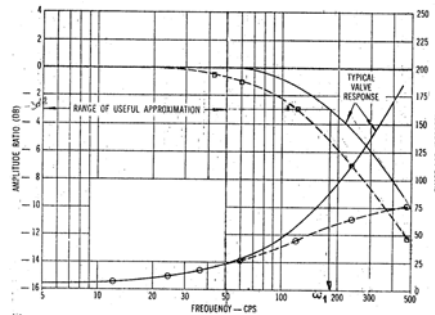


Figure 4. Bode diagram of the “Moog” servovalve

## MATHEMATICAL MODEL OF A ROLLING STAND

Linearisation of equation (1) gives equation (4):

$$H_i = H_{osi} + \frac{F_p}{E_s} \text{ given:}$$

$$H_i = H_{in} + (H_{osi} - H_{osin}) \frac{\partial H_i}{\partial H_{osi}} + \left[ (F_{pi} - F_{pin}) \frac{\partial H_i}{\partial F_{pi}} \right] \quad (4)$$

From equations (1) and (4) we can write equation (5) (in relative variations):

$$h_i = \frac{H_{OSIN}}{H_{IN}} h_{osi} + \frac{F_{pin}}{H_{in} E_{si}} f_{pi}$$

$$h_i = l_{1i} h_{osi} + l_{2i} f_{pi} \quad (5)$$

We consider cylinder piston rod, bottom work roll and bottom back up roll as “common” unit and therefore piston rod position change is the same as roll gap change. Therefore we can write equation (6):

$$h_i = l_{1i} y_c + l_{2i} f_{pi} \quad (6)$$

In the literatures [1] and [3] we can find equation (7) for the any of Sartid Cold Mill stand:

$$F_{pi} = \left[ \lambda_1 F_{K_{1i}} + (1 - \lambda_1) F_{K_{2i}} - \frac{2}{3} F_{Z_{2i}} - \frac{1}{3} F_{Z_{Pi}} \right]$$

$$\cdot \sqrt{R(Hu_i - H_i)}$$

$$\left[ 0,6 + 0,4 \sqrt{\frac{H_i}{H_{ui}} e^{\frac{\mu \sqrt{R_i(H_{ui} - H_i)}}{0,12H_i + 0,28H_{ui}}}} \right] +$$

$$+ \frac{2}{3} a_4 \sqrt{R_i H_i} (F_{K_{2i}} - F_{zpi})^{\frac{3}{2}} \quad (7)$$

$$F_{K_1} = a_1 \left( a_2 + \frac{H_{ui}}{H_0} \right)^{a_3}$$

$$F_{K_2} = a_1 \left( a_2 + \frac{H_{ui}}{H_5} \right)^{a_3}$$

For the soft steel are:

$$a_1 = 55,3; a_2 = 1,002; a_3 = 0,27; \lambda_1 = 0,2; a_4 = \sqrt{\frac{1 - \gamma^2}{E}}$$

$F_{zzi}$  - force of back tension,

$F_{zpi}$  - force of front tension,

$R$  - work roll diameter,

$H_0$  - thickness of the strip at the first stand entry,

$H_5$  - thickness of the strip at the last stand exit.

Therefore we can write equation (8):

$$F_{pi} = (H_{ui}, H_i, F_{zzi}, F_{zpi}) \quad (8)$$

We can obtain equation (9) (in relative variations) by linearisation of equation (8):

$$f_{pi} = \frac{H_{in}}{F_{pin}} \frac{\partial F_{pi}}{\partial H_i} \Big|_{h_i} + \frac{H_{uin}}{F_{pin}} \frac{\partial F_{pi}}{\partial H_{ui}} \Big|_{h_{ui}} +$$

$$+ \frac{F_{zziin}}{F_{pin}} \frac{\partial F_{pi}}{\partial F_{zzi}} \Big|_{f_{zzi}} + \frac{F_{zpin}}{F_{pin}} \frac{\partial F_{pi}}{\partial F_{zpi}} \Big|_{f_{zpi}}$$

$$f_{pi} = q_{1i} h_i + q_{2i} h_{ui} +$$

$$+ q_{3i} f_{zzi} + q_{4i} f_{zpi} \quad (9)$$

We can combine equations (6) and (9) and write equation (10):

$$h_i = \frac{l_{1i}}{1 - l_{2i} q_{1i}} y_{ci} + \frac{l_{2i} q_{2i}}{1 - l_{2i} q_{1i}} h_{ui} +$$

$$+ \frac{l_{2i} q_{3i}}{1 - l_{2i} q_{1i}} f_{zzi} + \frac{l_{2i} q_{4i}}{1 - l_{2i} q_{1i}} f_{zpi}$$

$$h_i = a_{1i} y_{ci} + a_{2i} h_{ui} + a_{3i} f_{zzi} + a_{4i} f_{zpi} \quad (10)$$



In the literature [1] are given all values for the coefficients  $g, l$  and  $a$ . Complete calculations, experimental results and producers catalogs give conclusion that in the rolling process with the »steady rolling speeds» (without considerations of taking in (accelerating)» and »taking out (slowing down)» the strip in (out) the rolling stand), the tension forces change smaller than 5% (lit [1]). Variations of the strip thickness which enters in the cold rolling mill are very small.

## CONCLUSION

Cold rolling of steel is very complex process. Knowledge of conditions in the roll bite is essential to achieve a good quality of final production. Some of its parameters may be determined exactly by measurement on the mill stand (geometrical dimensions, rolling force, front and back tensions, roll velocity), another only approximately by a suitable mathematical model (e.g. hardening of the processed material, friction coefficient between rolls and strip, strip temperature and flatness).

## REFERENCES

- [1] Jokovic Nebojsa, Postgraduate work: "Electrohydraulic servosystem for AGC", Mechanical Faculty-Belgrade, 1993.
- [2] "MOOG" Technical Bulletin 103, 1965
- [3] BRAYANT-AUTOMATION OF TANDEM MILLS –The Iron and Steel Institute, London 1963.
- [4] Adamovic Z, Maintenance of the Oilhydraulic systems, Belgrade, 1997.
- [5] Novica J. Specialistic work, "Functional analysis and comparative characteristics of servovalves "PPT" and "MOOG", Technical Faculty Mihailo Pupin, Zrenjanin, 2000.
- [6] F. Ďurovský et al., Computation of Rolling Stand Parameters by Genetic Algorithm, Acta Polytechnica Hungarica Vol. 5, No. 2, 2008

## NONLINEAR MATHEMATICAL MODEL OF A FLAPER TYPE OF SERVOVALVE

Novica Jevtić<sup>1</sup>, Nebojša Joković<sup>2</sup>, Jelena Danikov<sup>3</sup>

<sup>1</sup>Hidraulic, d.o.o., Smederevo, Serbia

<sup>2</sup>“Danieli”, Italia

<sup>3</sup>University of Novi Sad, Technical Faculty “Mihajlo Pupin”, Zrenjanin, Serbia

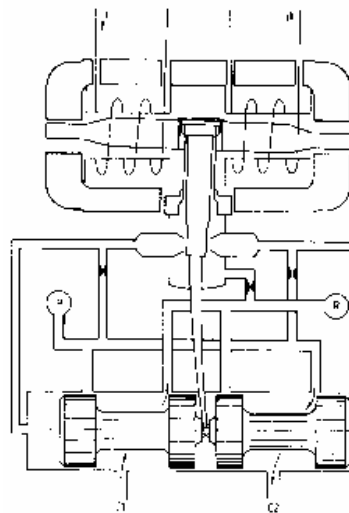
e-mail: [danikov@tfzr.uns.ac.rs](mailto:danikov@tfzr.uns.ac.rs)

**Abstract:** Electrohydraulic servosystems are used in hot and cold mill plants in US.Steel. Smederevo for the automatic gage control, roll bending and loopers. In the project »Supstution of jet type of servovalve by flaper type of servovalve (produced by domestic producer-PPT) » it is made complete analysis of these types of servovalves, many simulations and experimental measurements. In this paper is present nonlinear mathematical model of a flaper type of servovalve and mathematical model of hydraulic cylinder with unequal area piston.

**Keywords:** mathematical model, flaper type of servovalve

### INTRODUCTION

In many precise pneumatic control systems, flapper type servo valves are widely used as proportional elements neglecting the torque motor dynamics and flow force on the flapper inside the servo valve. Schematic of two stage electrohydraulic servovalve (flapper type) with force feedback is present at figure 1.



**Figure 1.** Schematic of two stage electrohydraulic servovalve(flapper type)with force feedback

A servovalve is an electro-hydraulic device that converts a low power electrical input into an amplified proportional hydraulic flow output. A servovalve consists of the following three subassemblies: torque motor, first stage and the second stage. Torque motor comprising the following elements: double permanent magnets, upper pole piece, lower pole piece, double coils and armature. Armature assembly consists of the following elements: armature, flexure tube, flapper and feedback spring. When current is made to flow through the armature coils, the armature ends become polarized and each end is attracted to one pole piece and repelled by the other. A torque is thus produced on the armature. The first stage of hydraulic amplifier consisting of a flapper and two nozzles. Armature end rigidly joined and supported by the thin-wall flexure tube. Main parts of the first stage are: two nozzles, two throttles, filter, flapper and first stage body. Fluid continuously flows through both inlet orifices, past nozzles into flapper chamber, through drain orifice to return. The forces of the hydraulic fluid are balanced. An electrical signal applied to the coils of the torque motor generates a

torque on the armature. The permanent magnets of the torque motor provide a de-centring force on the armature which offsets the mechanical stiffness on the flexure tube. This increases the net torque available for displacement of the flapper. A hydraulic bridge circuit is formed by supplying pressure to the fixed orifices via a filter and downstream of each of these, the two variable orifices formed by the nozzle-flapper interfaces. As the flapper is displaced, so the pressure output of the bridge circuit becomes unbalanced. Second stage of hydraulic amplifier consist of the following main parts: second stage body, spool and sleeve (bushing). The essential element of a servovalve is the valve spool, fitted as accurately as possible into the valve sleeve, in particular without axial underlap or overlap in the central position. As far as this is realized in practice, the flow area is exactly proportional to the stroke or displacement of the valve spool with no lap travel from the central position. Spool pushes ball end of the feedback spring creating restoring torque on armature flapper. As feedback torque becomes equal to torque from magnetic forces armature-flapper moves back to centered position. Spool stops at a position where feedback spring torque equals torque due to input current. This position of the valve spool is proportional to input current.

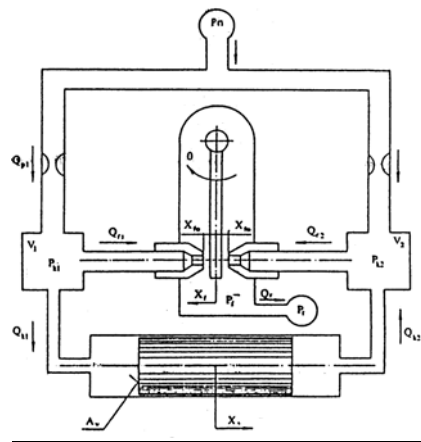
The main difference in construction of jet and flapper type of servovalve is in construction of the first stage. A basic difference between design of the jet and flapper types of servovalves is in the design of the first stage of hydraulic amplifier. Torque motor and second stage of both types of servovalve are very similar and therefore we will use the same equations for these elements

### TORQUE MOTOR

For the torque motor of the flapper type of servovalve we can use equation (1) :

$$K_i i = I_k \frac{d^2 \theta}{dt^2} + B_{Ak} \frac{d\theta}{dt} + (K_A - K_M) \theta + m_o \quad (1)$$

### First stage of hydraulic amplifier



**Figure 2.** Schematic of a first stage of hydraulic amplifier

According to literature [1] we can write equation (2):

$$\Delta p_k = \frac{p_s}{x_{f_0}} x_f \quad (2)$$

where:

- $\Delta p_k = p_{k_1} - p_{k_2}$  - difference of pressures in the both chambers of servovalve spool,
- $x_f$  - displacement of flapper,
- $x_{f_0}$  - equilibrium flapper position,

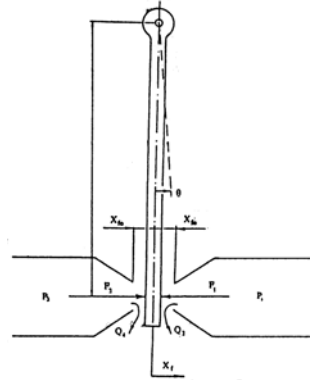


Figure 3. Flow forces on flapper

Using Bernoulli's equation we can write equation (3):

$$F_1 = (p_{k_1} - p_f)A_m + \frac{1}{2}\rho v_1^2 A_m \quad (3)$$

The fluid velocity at the plane of the nozzle diameter and is given by equation (4):

$$v_1 = \frac{Q_1}{A_m} = \frac{4\mu_f x_{f_0} \left(1 - \frac{x_f}{x_{f_0}}\right) \sqrt{\frac{2}{\rho}} \sqrt{p_{k_1} - p_f}}{D_m} \quad (4)$$

Similar reasoning leads to the equation for the force  $F_2$  and the net force acting on the flapper is the difference of these forces, and after some approximations (literature [1] we can write equation (5):

$$f_f = f_1 - f_2 = A_m p_s \frac{x_f}{x_{f_0}} \left[ 1 - \left( 4\mu_f \frac{x_{f_0}}{D_m} \right)^2 \right] \quad (5)$$

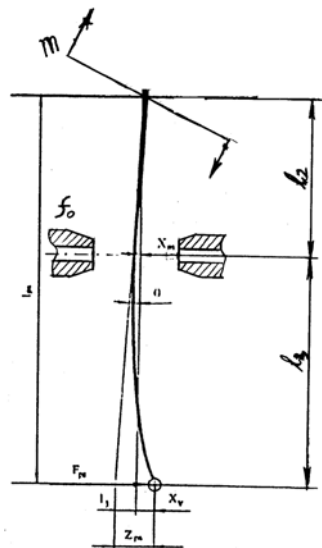


Figure 4. Forces and displacements of the armature assembly for the flapper type of servovalve

According to figure 4 we can write equation (6)

$$m_o = f_{ps} l_{ps} + f_f l \quad (6)$$

Where:

$$f_{ps} = K_{ps} z_{ps} = K_{ps} \left( l_{ps} \frac{x_f}{l_2} + x_v \right) \quad (7)$$

According to last equations and if we assume that  $l_u \approx 0$ , we can write equation (8)

$$\frac{B_{Ak}}{l_2} \frac{dx_f}{dt} = -\frac{K_{AC}}{l_2} x_f - K_{ps} l_{ps} x_v + K_t i \quad (8)$$

### Second stage of hydraulic amplifier-spool

Combination of equations we can write equation (9):

$$m_k \frac{d^2 x_v}{dt^2} = -B_{SV} \frac{dx_v}{dt} - 2c_d c_v w \cos \theta_{MLAZA} (p_s - p_L) x_v -$$

$$-k_{ps} x_v + \left( A_v \frac{p_s}{x_{f_0}} - k_{ps} \frac{l_{ps}}{l_2} \right) x \quad (9)$$

### MATHEMATICAL MODEL OF HYDRAULIC CYLINDER WITH UNEQUAL AREA PISTON

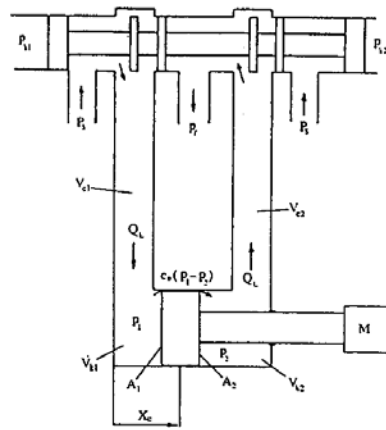


Figure 5. Schematic of servovalve spool and cylinder combination

The equation of motion of the cylinder piston can be written as equation (10):

$$F_{sp} + M \frac{d^2 x_c}{dt^2} + B_c \frac{dx_c}{dt} +$$

$$+ \text{sign} \dot{x}_c (K_c + K_s e^{-c\{x_c\}}) = p_1 A_{k_1} - p_2 A_{k_2} \quad (10)$$

where:

$F_{sp}$  - load opposing force,

$F_k$  - force of Columb friction,

$K_c$  i  $K_s$  - coefficients of Columb friction,

$c$  - coefficient which depends on velocity.

$$F_k = K_c + K_s e^{-\{x_c\}}$$

Applying the continuity equation to each of the piston chambers yields equations (11) and (12):

$$\frac{dV_{k_1}}{dt} + \frac{V_{k_1}}{B} \frac{dp_1}{dt} = Q_A - c_u (p_1 - p_2) \quad (11)$$

$$\frac{dV_{k_2}}{dt} + \frac{V_{k_2}}{B} \frac{dp_2}{dt} = Q_B - c_u(p_1 - p_2) \quad (12)$$

where;

$V_{k_1}$  -volume of forward chamber(includes valve,connecting line and piston volume),

$V_2$  -volume of return chamber(includes valve, connecting line and piston volume) ,

$c_u$  -internal leakage coefficient of piston

From the equations (11) and (12) we can write equation (13):

$$Q_L = \frac{Q_A + Q_B}{2} = \frac{1}{2} A_{k_1} (1 + \gamma) \frac{dx_c}{dt} + \frac{A_{k_1}}{2\beta} x_c \left( \gamma \frac{dp_2}{dt} + \frac{dp_1}{dt} \right) + \frac{V_0}{2\beta} \frac{dp_L}{dt} + c_u p_L \quad (13)$$

where:

$$\gamma = \frac{A_{k_2}}{A_{k_1}} \text{ and } p_1 - p_2 = p_L$$

According to literature [1] we can write equation (14):

$$Q_L = c_d w x_v \sqrt{\frac{1}{\rho} (p_s - p_L \text{sign} x_v)} \quad (14)$$

Equations (13) and (14) can be combined into equation (15):

$$\frac{dp_L}{dt} = \left[ \frac{v_0}{2\beta} + \frac{1}{4\beta} A_1 (1 - \gamma) x_c \right]^{-1} \left( c_d w x_v \sqrt{\frac{1}{\rho} (p_s - p_L \text{sign} x_v)} - \frac{1}{2} A_{k_1} (1 + \gamma) \frac{dx_c}{dt} - c_u p_L \right) \quad (15)$$

Transformation of equation (10) gives equation (16):

$$M \frac{d^2 x_c}{dt^2} = -B_c \frac{dx_c}{dt} - \text{sign} \dot{x}_c (K_c + K_s e^{-c \{ \dot{x}_c \}}) + \frac{1}{2} A_1 (1 + \gamma) p_L \quad (16)$$

## CONCLUSION

Mathematical models describe working of systems very well. It is made directives about comparisons and substitutions of different types of servovalves and we used these directives successfully in the Sartid Steel Plant.

## REFERENCES

- [1] Merrit H “Hydraulic control systems “John Wiley and sons”, 1967.
- [2] Novica J. Specialistic work, ”Functional analysis and comparative characteristics of servovalves “PPT” and “MOOG”, Technical Faculty Mihailo Pupin, Zrenjanin, 2000.
- [3] Adamovic Z, “Basic of hydraulic and maintenance of oilhydraulic systems” Beograd, 1997.
- [4] Blagojevic D, Postgraduate work, Mechanical Faculty, Belgrade,1993.
- [5] [Tao Wang](#), et al. Modelling of a 4-port Nozzle-flapper Type Pneumatic Servo Valve, [Systems Modeling and Simulation](#), 2007, pp 248-252.

## MATHEMATICAL MODEL OF SERVO-VALVE

Novica Jevtić<sup>1</sup>, Nebojša Joković<sup>2</sup>, Momčilo Bjelica<sup>3</sup>

<sup>1</sup>Hidraulic, d.o.o., Smederevo, Serbia

<sup>2</sup>“Danieli”, Italia

<sup>3</sup>University of Novi Sad, Technical Faculty “Mihajlo Pupin”, Zrenjanin, Serbia

e-mail: [bjelica@tfzr.uns.ac.rs](mailto:bjelica@tfzr.uns.ac.rs)

**Abstract:** The paper presents a mathematical model of the system for regulation of rolling thickness on five strands twin train.

**Key words:** mathematical model, rolling thickness, twin train

### INTRODUCTION

The system consists of: self-regulation piston-axial pump 1, filter 2, starting distributor 3, storage battery 4, servo-valve 5, hydraulic cylinder 8 with piston 9, lower support roller 10, lower working roller 11, rolling strip 12, upper working roller 13, upper support roller 14, device for setting up the given strip thickness (worm-pair) 15 together with strand casing 16, (spring with 15 denotes elasticity of complete structure) and an empty rectangle 18 which shows the electronic part of the system for automatic regulation. Number 17 denotes converter of position signal into electrical signal.

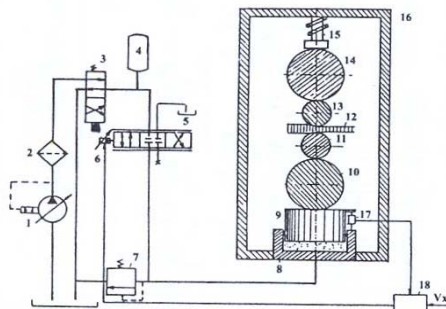


Figure 1. System for automatic control of strip thickness

### PRINCIPLE OF OPERATION

Before entry into the strand, distributor 3 is in the position shown in the figure so that the piston 9 is withdrawn, and by threaded ring the clearance of the rollers is set up according to the entering strip thickness. After that the spindle is blocked and clearance regulation (i.e. strip thickness) is done by the system presented in the figure 1. Piston-axial pump 1 gives the constant pressure  $p$ , and the flow which is required by servo-valve 5. Computer 18, based on the wanted clearance of rollers and measuring value of cylinder position, sends the error signal into regulating part of servo-valve 6.

Piston 9 presses the lower support roller and the lower support roller presses the lower working roller. Lower working roller presses the strip and effects the rolling force.

Structural diagram of this System for Automatic Control (SAC) is presented in fig. 2.

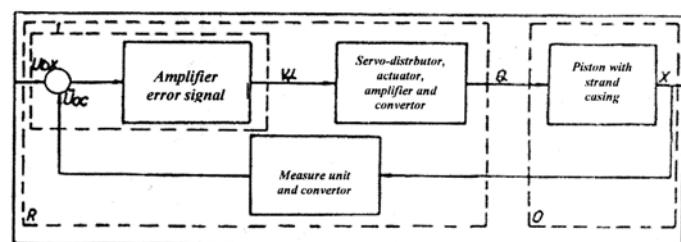


Figure 2. Structural diagram of the system for automatic control (SAC)

If the system from fig. 1 is drawn in a more detailed form appropriate for modeling, we shall obtain the models presented in fig. 3 and 4.

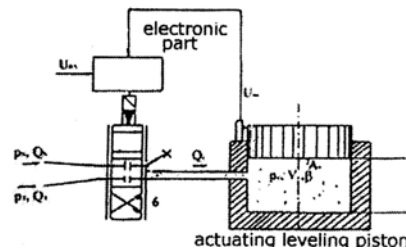


Figure 3. Schematic diagram of the connection between servo-valve and cylinder

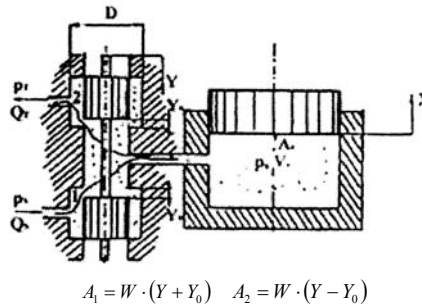


Figure 4. Hydraulic diagram of servo-valve and cylinder

### Comparator, giver and amplifier (booster) of the error signal is the computer

*Assumption 1:* Flow through servo-valve openings is turbulent.

This assumption enables application of Bernouille's equation for 1-3 and 2-3 in the form:

$$Q_1 = \frac{C_d \cdot W}{Y_0} + \left[ \frac{2}{\rho} \cdot (p_s - p) \right]^{\frac{1}{2}}$$

$$Q_2 = \frac{C_d \cdot W}{Y_0} + \left[ \frac{2}{\rho} \cdot (p - p_1) \right]^{\frac{1}{2}}$$

*Assumption 2:* Supply pressure at entry into the servo-valve is constant :  $p_s = \text{const}$

1. Inertia forces of working fluid are negligibly small.
2. The effect of temperature change on working fluid is neglected, which as a consequence has the fact that the fluid has a constant viscosity.
3. Hydro-dynamic forces are very small, so that they are neglected.
4. Zone or insensitivity threshold in servo-valve is neglected.
5. The loss of flow through side openings between the piston and servo-valve casing is neglected.
6. Hysteresis in electro-mechanical converter (torque-motor) of servo-valve is neglected.
7. In the gear and mechanical connections dead strokes are neglected.
8. Non-linearity of saturation in each component (electronic booster, hydraulic booster, servo-valve piston stroke, slope plate of servo-pump etc.) is also neglected.
9. Oil compressibility module is constant and independent of pressure and temperature.
10. In working fluid (oil) the content of free air is negligible.
11. Pipes under pressure are absolutely rigid.
12. Flow orifice in servo-valve is rectangular, i.e. the area gradient of flow orifice  $W = \frac{dA}{A}$  is a linear function of of servo-valve piston.
13. Servo-pump driving motor has the ideal mechanical characteristic, i.e. its revolutions are not the function of system load.
14. Coefficient  $K_e = \frac{\partial Q_{sr}}{\partial p_{sr}}$  is the curve slope of a general static characteristic of servo-valve in the working point.



15. Flow boosting coefficient of servo-valve  $K_q = \frac{\partial Q_{sr}}{\partial Y}$  is the slope of servo-valve flow characteristic and is valuable only in the limited working area, excluding the non-linear part of the curve and the saturation area. Storage battery volume is small.

### Servo-valves

According to the literature [7] and due to the assumption that  $T_x$  as a very small value is neglected, for the case of distributor with negative overlap,  $Y_0$  is written as a Bernouille's equation for 1-3, i.e. 3-2 (fig. 4) so that:

$$Q_1 = \frac{C_d \cdot W}{Y_0} + \left[ \frac{2}{\rho} \cdot (p_s - p) \right]^{\frac{1}{2}}$$

$$Q_2 = \frac{C_d \cdot W}{Y_0} + \left[ \frac{2}{\rho} \cdot (p - p_1) \right]^{\frac{1}{2}}$$

One must pay attention to the positive direction of the value  $Y$ , so that, if it is assumed that  $p_1 \approx 0$  one obtains:

$$Q_2 = C_d \cdot W \cdot (Y_0 - Y) \cdot \sqrt{\frac{2}{\rho} \cdot p}$$

From which it follows that:

$$Q_{sr} = Q_1 - Q_2 = C_d \cdot W \cdot (Y_0 - Y) \cdot \left[ \frac{2}{\rho} \cdot (p_s - p) \right]^{\frac{1}{2}} - C_d \cdot W \cdot (Y_0 - Y) \cdot \left[ \frac{2}{\rho} \cdot (p) \right]^{\frac{1}{2}}$$

If one adopts that  $K_q = C_d \cdot W \cdot \sqrt{\frac{2}{\rho}}$  then we have:

$$Q_{sr} = K_q \cdot (Y_0 + Y) \cdot \sqrt{p_s - p} - K_q \cdot (Y_0 - Y) \cdot \sqrt{p} \text{ Where:}$$

$Q_{sr}$  – flow through servo-valve, which goes into the cylinder

$Q_1 = Q_s$  – flow that goes into servovalve,

$Q_2 = Q_r$  – flow that goes from servovalve to the reservoir,

$W$  – rate at which flow is effected

$C_d$  – coefficient of outflow.

### Cylinder

Equation of flow, based on the literature [7] is:

$$Q_{sr} + C_i \cdot (p - p_0) = \frac{dV_c}{dt} + \frac{V_c}{\beta} \cdot \frac{dp}{dt}$$

According to the assumption: according to the literature [8], flow assumption of servo-valve might be linearized in relation to the declination of plate from neutral position and difference of pressure acting on the piston, the leakage is neglected  $C_i \approx 0$ , where:

$V_c$  – oil volume in the cylinder at any time,

$V_0$  – oil volume in the starting moment, then we have

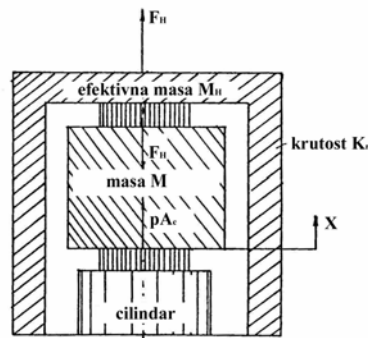
$$V_c = V_0 + A_c X$$

So that:

$$\frac{dV_c}{dt} = \frac{dV_0}{dt} + A_c \cdot \frac{dX}{dt} = A_c \dot{X}$$

### Strand casing

Fig. 5 gives schematic diagram of the strand casing.



**Figure 5.** Schematic diagram of the strand casing

Due to application of the assumption: according to the literature [8] servo-valve flow assumption may be linearized related to the plate declination from the neutral position and the pressure difference acting on the piston, the following equation is valid:

$$F_H - K_R \cdot (X - X_0) = M_H \cdot \ddot{X}$$

$$F_H = K_R \cdot (X - X_0) + M_H \cdot \ddot{X}$$

### Cylinder

Based on fig. 5, it follows that:

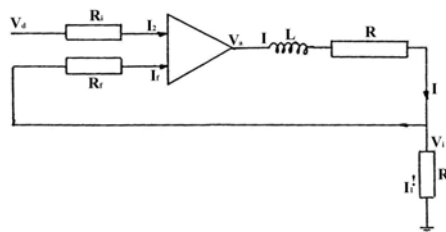
$$PA_c - F_H = M \ddot{X}$$

$$PA_c = F_H + M \ddot{X}$$

Relying on the literature [7], the following assumption may be written: Piston movement depends on input current  $I_y$  according to the formula:

$$Y = V(S)I$$

### Servo-valve supply circuit



**Figure 6.** Servo-valve supply circuit

Based on fig. 6 with the application of Kirhov's rules and the equation of current-voltage amplifier [6] the following equations are obtained:

$$\left( \frac{V_d}{R_i} + \frac{V_i}{R_f} \right) \cdot (-K_a) = V_a$$

$$I = \frac{V_a - V_i}{LS + R}$$

$$I = I_f + I_1$$

### Converter of position signal into voltage signal

Signal converter effects the amplification  $K_f$ . These converters are simple to use but they introduce the noise into the system so that because of that this noise is removed by introduction of time constant  $\tau_f$  by which the effect of that noise is reduced.

According to the literature [6] one may write the equation:

$$U_{oc} = \frac{K_f}{1 + \tau_f \cdot S}$$

### Error signal amplifier

This amplifier reacts to the difference between wanted and achieved voltage and effects the voltage which is proportional to that error and according to the literature [6] one may write the equation:

$$(U_{bx} - U_{oc}) \cdot K_a = -V_d$$

All preceding equations represent a non-linear mathematical model of this system for controlling the strip thickness. Fig. 7 presents an analogue diagram of the system for control of strip thickness based on all previous equations.

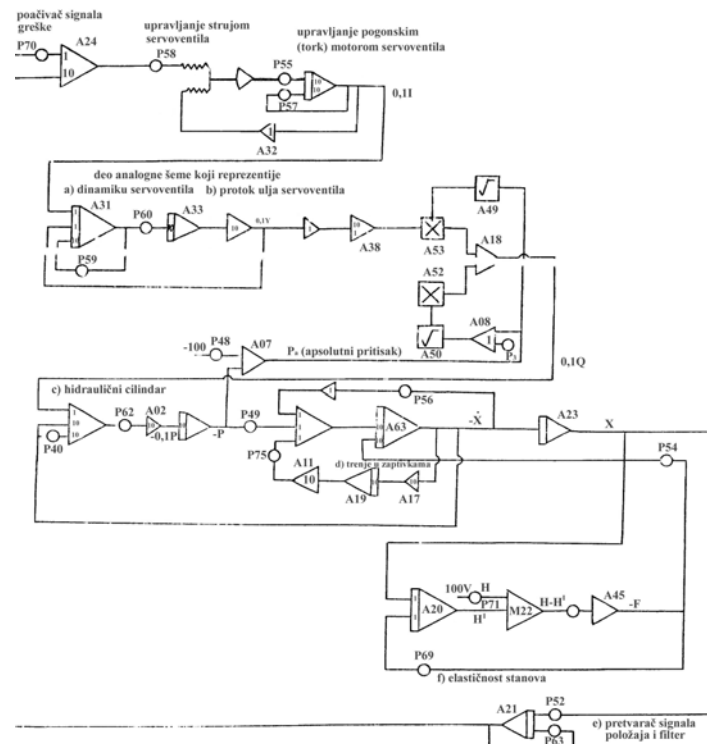


Figure 7. Analogue diagram of the System for Automatic Control (SAC) of rolling thickness

### ELABORATION OF THE LINEARIZED MATHEMATICAL MODEL LINEARIZATION OF SERVO-VALVE FLOW CHARACTERISTIC

We shall observe the functioning of servo-valve around the zero position (i.e. small deviations from neutral position) –  $-Y_0 < Y < Y_0$ .

$$q = \frac{\partial Q}{\partial Y} \int Y + \frac{\partial Q}{\partial P} \int P + R_4$$

$R_4$  is neglected as a small value.

From the equation

$$Q_{sr} = K_q \cdot (Y_0 + Y) \cdot \sqrt{P_s - P} - K_q \cdot (Y_0 - Y) \cdot \sqrt{P}$$

It follows

$$\left. \begin{aligned} \frac{\partial Q}{\partial Y} &= K_q \cdot \sqrt{p_s - p} + K_q \cdot \sqrt{p} = C_y \\ \frac{\partial Q}{\partial p} &= \frac{K_q(Y_0 + Y)}{-2\sqrt{p_s \cdot p}} - \frac{K_q(Y_0 - Y)}{2\sqrt{p}} = C_p \end{aligned} \right\}$$

From which one obtains:

$$q = \left( K_q \cdot \sqrt{p_s - p} + K_q \cdot \sqrt{\frac{p}{y}} + \frac{K_q(Y_0 + Y)}{-2\sqrt{p_s \cdot p}} - \frac{K_q(Y_0 - Y)}{2\sqrt{p}} \right) \cdot p = C_y \cdot y + C_p \cdot p$$

In the literature [4] it is shown that  $C_p \approx 0$  so that:  $q \approx C_y \cdot y$

**Casing:**  $f_H = K_R x + M_H \ddot{x}$

**Cylinder**  $pA - f_H = M \ddot{x}$

Equation of the oil flow in the cylinder is:

$$Q = A \dot{X} + \frac{V_c}{B} \cdot \dot{P} = Q(\dot{X}, \dot{V}_c, \dot{P})$$

If this equation is developed into Taylor's series, one shall obtain:

$$q = \frac{\partial Q}{\partial \dot{X}} \dot{X} + \frac{\partial Q}{\partial \dot{V}_c} \dot{V}_c + \frac{\partial Q}{\partial \dot{P}} \dot{P} + R_5$$

$R_5$  is neglected as a small value.

$$q = A \cdot \ddot{x} + \frac{\dot{P}}{B} \cdot V_c + \frac{V_c}{B} \cdot \dot{p}$$

If pressure deviations are small,  $P = const \Rightarrow \dot{P} = 0$  then we have:

$$q = A \ddot{x} + \frac{V_c}{B} \cdot \dot{p}$$

Servo-valve supply is:  $Y = V_{(s)} I$ .

### Servo-valve supply circuit

Fig. 8 shows the block diagram of servo-valve supply circuit.

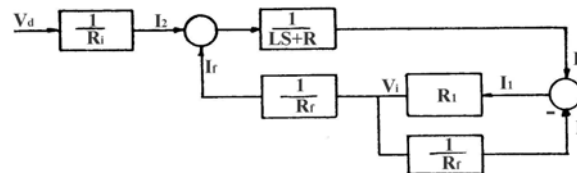


Figure 8. Block diagram of servo-valve supply circuit

From the block diagram of servo-valve supply circuit (fig.1), one obtains:

$$W_K = \frac{K_e}{R_i} \cdot \frac{1}{LS + R + K_e \cdot \frac{R_1}{R_1 + R_f}} \cdot \frac{1}{LS + R + K_e \cdot \frac{R_1}{R_1 + R}} = \frac{1}{R + K_e \cdot \left( \frac{R_1}{R_1 + R_f} \right)} \cdot \frac{1}{R + K_e \cdot \frac{R_1}{R_1 + R}} = \frac{1}{R + K_e \cdot \left( \frac{R_1}{R_1 + R_f} \right) + LS} \cdot \frac{1}{1 + \frac{LS}{R + K_e \cdot \left( \frac{R_1}{R_1 + R} \right)}}$$

From which it follows:

$$I = \frac{\frac{1}{R_i} \cdot \frac{K_e}{R + K_e \cdot \left( \frac{R_1}{R_1 + R_f} \right)}}{1 + \frac{LS}{R + K_e \cdot \frac{R_1}{R_1 + R}}} \cdot v_d = \frac{K_x}{1 + \tau_x S} \cdot v_d$$

### Converter of position signal into voltage signal

$$V_{oc} = \frac{K_f \cdot x}{1 + \tau_f S}$$

### Error signal amplifier

$$K_a \cdot (v_{bx} - v_{oc}) = -v_d$$

Previous equations represent a linearized mathematical model of the System for Automatic Control (SAC) according to deviations.

By applying Laplace's transformations, for zero starting conditions, for each equation from this system one obtains the following system of equations:

$$Q(s) = C_y Y(s)$$

$$F_H = K_R X(s) + M_H S^2 X(s)$$

$$PA = F_H + MS^2 X(s)$$

$$Q(s) = ASX(s) + \frac{V}{B} SP(s)$$

$$I(s) = \frac{K_X}{1 + \tau_X S} \cdot V_d$$

$$V_{oc(s)} = \frac{K_f}{1 + \tau_f S} \cdot X(s)$$

$$K_a \cdot (V_{bx} - V_{oc}) = -V_d$$

$$Y(s) = V(s) - I(s)$$

From equations:  $W_{\theta(s)} = \frac{\theta(s)}{I_y(s)} = \frac{K_{\theta}}{T_{\theta}^2 S^2 + 2\xi_{\theta} T_{\theta} S + 1}$  and  $W_{y\theta(s)} = \frac{Y(s)}{\theta(s)} = \frac{K_{y\theta}}{T_{1H} S + 1}$

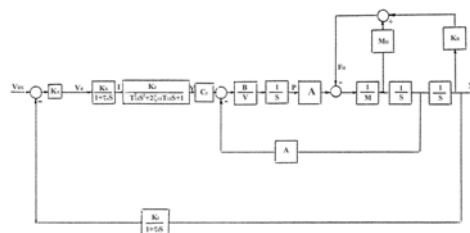
With the validity of the assumption from the literature [8] that  $T_{\theta 1}$  is a small value which may be neglected, it follows that:

$$V(s) = \frac{K_3}{T_{\theta 3}^2 S^2 + 2\xi_{k3} T_{e3} S + 1}$$

Accordingly, because of that, we have:

$$Y(s) = \frac{K_3}{T_{e3} S^2 + 2\xi_{k3} T_{e3} S + 1} \cdot I(s)$$

Based on previous equations a block diagram may be drawn of the system for controlling the strip thickness (fig. 9).



**Figure 9.** Block diagram of the system for strip thickness control

If the block diagram from fig. 9 is represented in the basic form, we shall obtain:

$$W_{ok} = \frac{K_a \cdot K_x}{1 + \tau_x S} \cdot \frac{K_3}{T_{\theta 3}^2 S^2 + 2\xi_{k3} T_{e3} S + 1} \cdot C_y \cdot \frac{K_4}{S^2 + K_5^2} \cdot \frac{1}{S} \cdot \frac{K_f}{1 + \tau_f S}$$

### REFERENCES

- [1] Adamovic Z, Jevtic N. Overhaul of hydraulic systems, SARTID-ad, Smederevo, 1999.
- [2] Askovic Retal.: Hydraulics, Magazine "OMO", Belgrade, 1985.
- [3] Adamovic Z, Maintenance of the Oil hydraulic systems, Belgrade, 1997.
- [4] Jevtic N. Master's thesis, Technical Faculty "M.Pupin", Zrenjanin, 2001.
- [5] Herbert e. Merit, HYDRAULIC CONTROL, John Wiley, 1967.
- [6] Popov D. Dynamics of objects and processes, Faculty of Mechanics, Belgrade, 1981.

## NEW TECHNOLOGY DUAL FUEL FOR USE OF LNG AS TRANSPORT FUEL FOR SHIPPING

### Liquid Natural Gas potential for future transport fuel

Renio Čaleta<sup>1</sup>, Slavica Prvulović<sup>2</sup>, Eleonora Brtka<sup>2</sup>

<sup>1</sup>Jugoslovensko Rečno Brodarstvo (JRB), Serbia

<sup>2</sup>University of Novi Sad, Technical Faculty "Mihajlo Pupin", Zrenjanin, Serbia

e-mail: [chaleta@gmail.com](mailto:chaleta@gmail.com)

**Abstract:** This work represents the review of newly developed technology using Liquid Natural Gas (LNG) as substitution fuel for transport. Impact of use, and future of use of LNG, safety of technology and ease of use. Drawbacks of technology to use LNG and paths for Serbia.

**Key words:** Liquid Natural Gas (LNG), Production, Technology, Transport, Maritime and River shipping, Danube

### INTRODUCTION

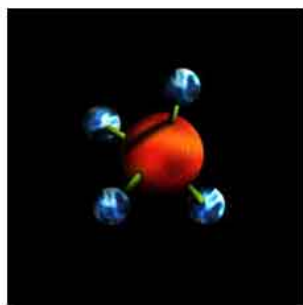
For many years world is searching for new ways of using existing technologies or developing new ones to meet the stricter forms and legislation of GHG (Green House Gases) emissions and environment protection. Imminent fossil fuel depletion pushed civilization to think about alternatives for existing fuel options or their substitution with new ones.

Liquid Natural Gas shortly known as LNG was known to us for many years, but not until a two decades ago it raised attention. Primary it was shipped as LNG and then transferred into Natural Gas (NG) used for heating, cooking but until recently it was not used as transport fuel.

Liquefied Petroleum Gas (LPG) with which it is often confused in common people talks is very different both in consisting elements and chemical and transport properties. LPG technology is today very developed and it reached levels where it would be highly impossible for further significant technology development. In our everyday life we use it in our cars for transport, but it has limitations to be used only with cars that use gasoline not diesel engines. This barrier is made due to the technology difference in the way of ignition of the fuel mixtures.

### Basic difference between LPG and LNG

Liquefied Petroleum Gas (LPG) contains mainly Propane (C<sub>3</sub>) and Butane (i-C<sub>4</sub> & n-C<sub>4</sub>), Liquid Ethylene (C<sub>2</sub>=) and Liquefied Natural Gas (LNG) contains mainly Methane will evaporate at ambient condition e.g. 20 deg C at pressure 101.325 kPag.



Graphic: California Energy Commission

**Figure 1.** Methane space model, main ingredient in LNG

Methane (CH<sub>4</sub>) is commonly known as natural gas. It is colorless and burns efficiently without many byproducts. Natural gas has odor added as a safety measure since it is naturally odorless.

LNG (liquefied natural gas) is natural gas cooled down to approximately -163 °C at atmospheric pressure and transported as a liquid. It is now rapidly becoming a widely used engine fuel in

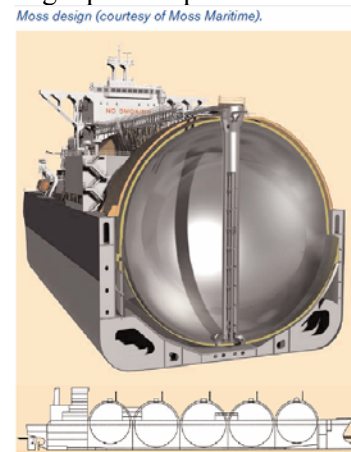
association with its growing popularity as an energy source worldwide.

LPG, Liquid Ethylene and LNG can be stored in refrigerated vessel at its bubble point and atmospheric pressure. Their bubble point can be as low as -40, -104 and -162 degC are commonly known as cryogenic temperature and fluid as cryogenic fluid.

Heat leaks into the cryogenic fluid will results vaporization and lead to Boil-Off-Gas (BOG) generation. Other than heat leak, there are other scenarios can lead to BOG generation:

1. vaporized vapor due to barometric pressure decrease
2. vaporized vapor due to ambient temperature increase
3. cryogenic fluid rundown piping
4. cryogenic fluid circulation / loading line
5. ship / truck loading arm
6. cryogenic fluid storage tank
7. cryogenic fluid rundown pump
8. cryogenic fluid in-tank pump
9. flashed non-condensable gasses
10. negative Joule-Thompson effect
11. "hot" rundown LNG into "cold" LNG
12. cooling of loading arm
13. cooling of ship / truck

During transport on tanker ships a specific effect occurred, since it has a very low boiling point, part of transported gas heated and was released as boil-off gas to relief the building-up of the pressure.



**Figure 2.** Tanker ship for carrying LNG from bunker-to bunker (on the left) and cross section of typical LNG chamber on the tanker designed by Moss maritime (on the right).

This occurred because of low development of technology for the isolation of pressure vessels. A cryogenic fluid is typically kept at low temperatures in a storage vessel.

The storage of LNG on tanker transporter has a major challenge due to the inherent heat input from the environment.

Effect of the heat input is warming of the cryogenic fluid:

- If (constant volume) then pressure increase in the storage vessel, other case is
- If (constant pressure) then fluid boils and "boil-off" vapours are released from the vessel (venting)

The vapours created due to the ambient heat input (while maintaining constant pressure in the storage vessel) are called "boil-off". Discharge of these vapours out of the storage container is called venting.

Since this technology improved boil-off gas (BOG) was almost eradicated as an effect and new systems were developed and they were called "zero boiled-off" gas systems.

## LNG GASES TYPE GENERATED

LNG quality differences in the engine operation:

There are two distinct types of gas made from LNG depending on how it is extracted:

- **“natural boil-off gas”** which is taken off the top of the LNG tanks above the liquid will have a high methane content and some nitrogen and thus have a high knocking resistance. Analysis show values typically around MN 100 and LCV between 33 – 35MJ/nm<sup>3</sup>. (Initial gas extraction after uploading may have reduced calorific value because of the high nitrogen content at the top of the tanks). This is a somewhat special application typical for fuelling of LNG tanker propulsion plants
- **“forced boil-off gas”** i.e. LNG extracted from down in the tanks and evaporated separately. This gas will contain a mixture of all hydrocarbons in the liquid and its resistance to knocking may differ from origin to origin and even from load to load, with the MN typically in the range between 70 and 80. The calorific value will be higher than natural boil-off gas and quite stable at around 38 – 39 MJ/nm<sup>3</sup>. This gas type is now becoming very popular as fuel for general shipping.

### Some reasons why the LNG composition may differ

Per definition LNG is natural gas which has been cooled down so much that it is made into a liquid. As is well known the base natural gas from which it is made not only contains methane - although this is by far the main component, but also ethane, propane and even some butane, so during the condensation process these other components and a certain amount of nitrogen will be present as well. Because methane requires the lowest temperature for liquefaction (after nitrogen), other hydrocarbons which may be present in the natural gas will all become liquids before the methane during the cooling-down process. Therefore it is normal to take out most of these in a process called “fractioning” and which can be explained by the boiling temperatures and liquid densities.

Previous technology development concentrated only to the use of BOG, problems of using it was solved in the manner that every ship had Boil-off plant mounted on it.

This technology had many drawbacks, from high price for installation to large space needed and economically high investment return for it, and also availability on commercial scale only with access to large quantities of LNG (mainly in LNG tankers and re-liquefaction plants). This prevented technology to reach commercial levels of LPG which took over the automotive industry in passenger cars.

Until development of dual-fuel technology LNG was not seen as a potential to replace diesel/gasoline as transport fuel.

### BI-FUEL (or DUAL FUEL) TECHNOLOGY- LNG AND DIESEL

First works on bi-fuel concept were separately developed from the many companies and innovators and brought in many shapes, during time it filtered final solution. This solution is very simple but effective and this even brought a development for engines which nowadays are produced especially for LNG use and even further development where dual fuel energy is slowly shifting towards direct use of LNG only without any quantities of diesel.

This paper will focus on solution which proved as most economically sound and materials used are from TRILOBES company, which internationally has installed many power generation plants. Also as a possible solution for river shipping will be presented the vision of one man Mr. Gerhard Deen, who was the first to completely tie up a solution for river shipping proving economic drive and safety of the technology.



## **MATERIAL AND METHODS**

### **EMPLOYED METHODS**

Bi-fuel operation means the engine uses two fuels (gas and diesel oil) at the same time. Natural gas is intended as the main fuel and diesel oil is used for the ignition of the gas/air mixture inside the cylinder (a portion of diesel oil is injected at the end of the compression stroke, thereby maintaining the original diesel operation principle).

Trilobes power systems (or ComAp) provides two conversion technologies – one for slow-speed engines (up to 1000 rpm) which are very reliable and widely used in ship industry and the second for high-speed engines (1500 rpm, 1800 rpm) these are new build engine very similar to the truck and bus engines. Choice of the appropriate ComAp solution is determined by the existing engine (which is considered to be one of the main advantages of this technology) speed and consequent suction/exhaust valve overlap (i.e. opening of suction and exhaust valves at the same time).

Slow-speed engines normally feature a large valve overlap when the pure air is flushing (cleaning) and cooling the cylinder. After bi-fuel conversion, it is necessary to continue cylinder flushing/cooling by pure air, i.e. gas flow into the cylinder during the valve overlap must be interrupted to avoid the presence of gas in the hot exhaust manifold (this would cause a potentially dangerous situation and result in substantial fuel losses). Therefore, each cylinder is equipped with the patented electromagnetic gas valve with variable gas injection timing controlled by a ComAp electronic control system INCON.

In contrast, high-speed engines have only a small valve overlap, so it is possible to install just a central mixer(s) before the turbocharger(s) for the continuous flow of the gas/air mixture. Gas injection is controlled by a throttle operated by the ComAp electronic control system InteliGen-BF according to the required engine output and speed.

### **HOW IT WORKS**

Gas is injected into the cylinder inlet manifold by individual gas electromagnetic valves installed as close to the suction valves as possible. The valves are separately timed and controlled by the ComAp injection control unit INCON.

This system interrupts the gas supply to the cylinder during the long overlap of the suction and exhaust valves (just typical for slow-speed and medium-speed engines – within the valve overlap cylinder scavenging is performed).

This avoids substantial gas losses and prevents dangerous gas flow to the exhaust manifold.

System for conversion of industrial diesel engines to bi-fuel operation by substitution of typically 60–90% natural gas for diesel or HFO.

This technology is very suitable for engines with speed below 1000 RPM and output above 500 kW which is also important from the economy point of view, since this technology fails to prove use for individual cars since ROI (Return Of Investment) depends on the previously used quantity of the fuel and price of conversion to bi-fuel technology.

Advantages of this technology is:

- No reduction of engine power or efficiency
- Smooth transition between diesel and bi-fuel modes at any time
- Gas is injected directly before intake valve by high speed electromagnetic valves, one valve per Cylinder
- No modification of internal engine components is required
- Automatic equalization of exhaust gas temperatures from individual cylinders

### **BASIC SCHEME OF THE CONVERTED ENGINE**

Below is given basic outlook of the converted engine with necessary adaptation to use Bi-fuel technology (Figure 3.)

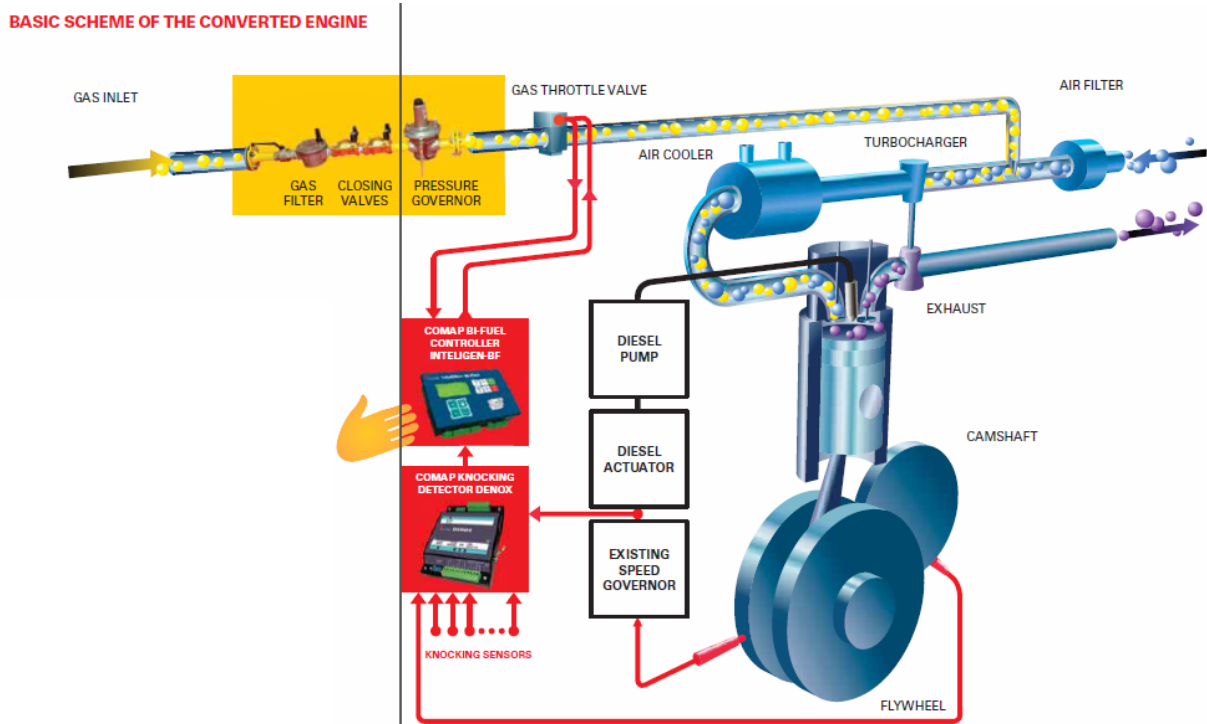


Figure 3. Basic Scheme of converted engine, monitoring technology developed by ComAp

#### ELEMENTS OF THE SYSTEM

Elements of the system are the following (also available to view on the figure 3):

- Electromagnetic gas valves with gas/air blenders
- ComAp electromagnetic valves control unit INCON
- ComAp Bi-Fuel automatic control unit InteliSys Bi-Fuel
- ComAp bi-fuel governor ECON-2S
- Safety valve(s) for air filling manifold
- Gas train (gas manifold, gas governor, double closing valve, filter, ball valve etc.)

#### MAIN FEATURES

One of very important features in all newly developed technology is automation of the system. Also another feature which is very important is the lower emissions with which engine can pass strict EPA and IMO regulations, which are proposed to be applied by end of 2020.

- Completely automatic system
- Extremely efficient operation – only very small percentage of diesel is necessary
- Cheaper electricity production
- Non-derated output power
- The same response to load steps
- High stability of the engine
- Lower emissions
- Possibility of pure diesel operation maintained
- Prolonged service intervals

On the figure 4. Is shown the look of the installed system on the engine.



Figure 4. Picture of installed bi-fuel by ComAp on Caterpillar engine C15. (Courtesy of ComAp)

### ECONOMY FOR TECHNOLOGY ADAPTATION

According to the case study, profit behind this technology is more than promising. Mainly mixtures for use in engines are made by 80% of LNG and 20% of diesel.

Below are given data for a sample engine of Caterpillar model 3512B, 1500 kVA, 1500 RPM (figure 5.)

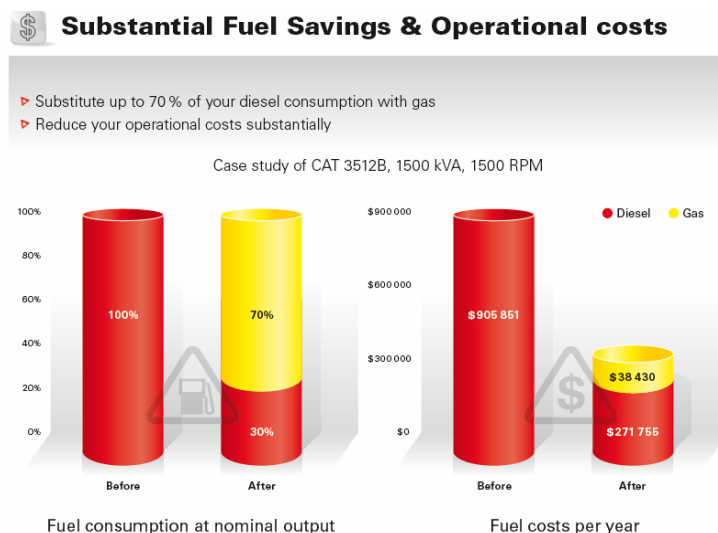


Figure 5. Case study results in real exploitation. (Courtesy of ComAp)

### ENVIRONMENT ADVANTAGES

ComAp Bi-Fuel is a more environmentally friendly solution for Diesel engines and have a positive effect on GHG emissions.

Emission reductions possible:

- Reduction of CO<sub>2</sub> – 5% to 20%
- Reduction of NO<sub>x</sub> – 30% to 40%
- Reduction of SO<sub>x</sub> – 70% to 100%
- Reduction of Particulate emissions (PM) – up to 50%

Together with the option of the fitment of a catalytic convertor, significant reduction of CO can also be expected.

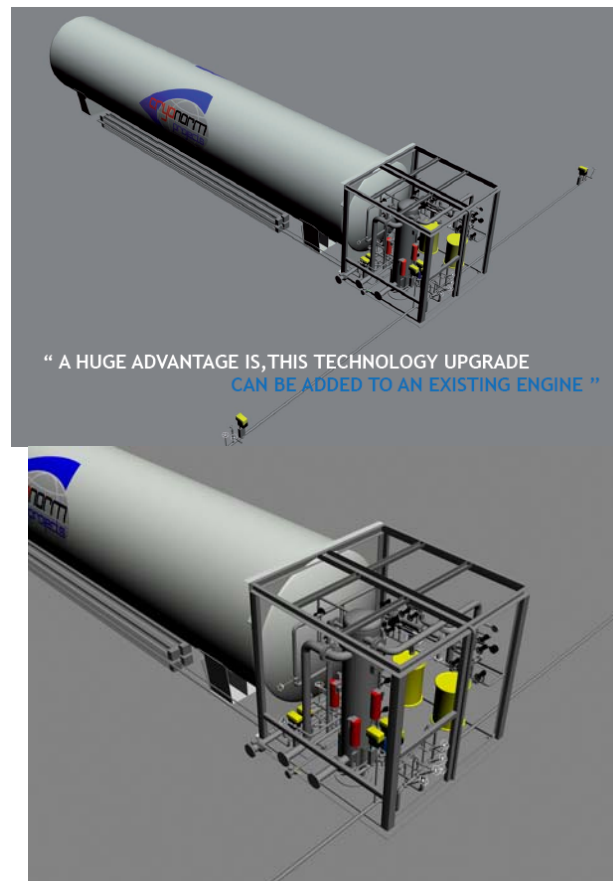
## OTHER IMPORTANT BENEFITS AND FEATURES

Fuel flexibility stays as very important option since availability of LNG is only in the highly developed areas, like Rotterdam port, or on the LNG plant production location.

Maintenance savings – longer oil life and increased periods between required maintenance intervals. Since the lower pollutants quantities less pollution is made also to the engine oil which produces the longer exchange periods and overhauling periods, which can significantly reduce operating costs.

Like in many substitution very important issue is loss of available power, but here no de-rating of engine power output or performance – ideal for transient loads, this keeps smooth operation and ease of use of LNG.

This technology is fully automatic and dynamic solution which will maximize the substituted gas



**Figure 6.** Tank and installation technology applied to hold LNG on the ship, designed by CRYONORM – Holland, to run on bi-fuel technology

All engine parameters can be kept within limits of specified by the engine manufacturer:

- Engine boost air and exhaust temperatures measurement, monitoring/protection
- Minimum & Maximum Gas pressure measurement, monitoring/protection
- Comprehensive Knocking detection system – Frequency sensors are fitted to every cylinder, which enables the use of different quality of LNG and protection of the system itself.
- Diesel portion mapping and measurement with real time monitoring
- Actual Load measurement
- Minimum Load gas protection

Other features as we might call them advantages are smooth transition between diesel and bi-fuel operations at any time, non-intrusive solution – no change of any engine parts required which considerably lower the costs of technology implementation, gas/diesel ratio display.

In addition some feature help to overcome technology gaps between existing equipment and new business needs like full history files recording, remote monitoring, control and configuration via PC or via internet.

## IMPLEMENTATION IN RIVER SHIPPING

This technology is shifted from Maritime industry to river shipping first time in 2011. Preparations were made and done by a visionary Mr Gerhard Deen, owner of the DEEN SHIPPING and for this effort he in cooperation with Caterpillar PONCat made it possible. For this innovation he is awarded the special recognition from EU.

First ever built river tanker on LNG fuel (bi-fuel technology) was made in Holland and in 2011 passed all safety and other regulations and started a new era in river transport. This first ship is called ARGONON (shown on figure 7.).



**Figure 7.** First inland tanker Argonon to run on bi-fuel technology in the world, property of the Deen Shipping, ([www.argonon.nl](http://www.argonon.nl))

## RESULTS AND DISCUSSION

Varios aspect should be discussed, and technology is at development stage.

### Safety of natural gas

Working with natural gas is a safe technology. You only have to consider the fact that every Serbian household uses it for cooking and heating, and that gas pipelines are laid throughout the Serbia, right up to the living room. LNG is a very different product than LPG, with which it is often confused. Contrary to LPG, LNG is lighter than air, and dissipates readily. So there are no drastic safety measures required for a vessel to be LNG-powered. The gas on a river freighter is held at minus 170°C. At this temperature it is liquid, rather than gaseous, and it can be safely stored in a cryogenic tank, which is a double-walled tank with a vacuum in between the two walls. This maximizes the insulation value, and the gas stays at almost exactly the right temperature to remain liquid. Over the time, the temperature of LNG slightly increases, causing evaporation. This gas (blow-off) is discharged via a pressure relief valve. However, rather than venting into the atmosphere, the gas is collected and used to generate electricity.

### Major benefits for shipping

Sailing with a Bi- Fuel engine is not different than sailing with a diesel engine. The difference is hardly noticeable on the bridge. The natural gas tank has sufficient capacity to fuel a journey from Rotterdam to Switzerland and back. Natural gas is a simple chemical compound with a simple structure. It requires only minor industrial processing to prepare it for use. This makes it much cheaper than other fuels. Unlike petroleum-based fuels, the world reserves of natural gas are enormous. Equally important is the fact that its combustion generates half as much CO<sub>2</sub>, so it to reduce the emission of greenhouse gasses. Thanks to its reduced emissions, low cost and excellent performance, natural gas is a serious alternative fuel for marine applications.

### Bi- fuel on the Argonon ship

Argonon Shipping is owned by Deen Shipping. A cryogenic LNG tank has been installed on the deck, with an evaporator that converts the liquid LNG into natural gas. In the “gas fuel system”, the gas is drawn in to a venturi (a constriction that reduces gas pressure), mixed thoroughly with the combustion air, and subsequently metered into the engine. The ship is equipped with a micro-turbine that is fully powered by natural gas, and requires little maintenance. The turbine generates electricity and heat, and is built as a combined heat and power (CHP) plant. The exhaust gasses at a temperature of 300°C pass through a heat exchanger that heat up water to between 80 - 90°C. The hot water flows to the LNG evaporator, the main engines, the central heating system and under-floor heating in all cabins. The extent of reductions achieved in emissions of NO<sub>2</sub>, NO, CO, CO<sub>2</sub>, CH<sub>4</sub> and particulate matter will become clear in the course of the pilot study. But reductions there will be certain. The combustion of natural gas is cleaner, and produces less soot and particulates. The use of cleaner-burning fuel also allows extended service intervals, yielding economies on both fuel and exploitation costs.

### CONCLUSION

This technology is here to stay and develop further, for this years of use it shows tremendous potential. New development of engines are already happening and engine producers are going to the next step and offering engines which can solely run on LNG, this is probably the future of this transport fuel. In the world there is also an increasing production of B-LNG, newly developed trade mark. This is LNG produced solely from the biomass. By achieving this it becomes virtually available everywhere. This brings clean energy to all parts of the world, with sustainable and local development according to the needs of the market. From what is seen this combination is the next star of transport fuels.

### REFERENCES

- [1] A Contingency Planning and Crew Response Guide for Gas Carrier Damage at Sea and in Port Approaches –1999, SIGTTO
- [2] Barron, Randal F, Cryogenic Systems, Second Edition, Oxford University Press, 1985
- [3] CIMAC WORKING GROUP ‘GAS ENGINES’ INFORMATION ABOUT THE USE OF LNG AS ENGINE FUEL, CIMAC is the International Council on Combustion Engines, <http://www.cimac.com/.2008>
- [4] ComAp, Brochure BI-FUEL CONVERSION OF DIESEL & HFO GENERATING SETS
- [5] Liquefied Gas Handling Principles on Ships and in Terminals – SIGTTO
- [6] Manuel Lage, Dr. Eng., From GasHighWay to LNG Blue Corridors The new dimension of NGVs development, GasHighWay Final Seminar, Brussels, 1st March 2012
- [7] Mooring Equipment Guidelines – 2001, OCIMF
- [8] Safe Havens for Disabled Gas Carriers – 2003, SIGTTO
- [9] Shin Y. et al., 2008, Design of a boil-off natural gas reliquefaction control system for LNG carriers, *Applied Energy*, Elsevier Ltd. Pp. 37-44
- [10] Ship-to-Ship Transfer Guide (Liquefied Gases) – 1995, SIGTTO
- [11] The International Code for the Construction and Equipment of Ships Carrying Liquefied Gases in Bulk, (IGC Code) – IMO
- [12] Wegrzyn, J., Gurevich, M., “Liquefied Natural Gas for Trucks and Buses”, SAE Paper No. 2000-01-2210
- [13] Weisend II, J. G., Handbook of Cryogenic Engineering, Taylor and Francis, 1998
- [14] What is Boil-off?, LNG Task Force meeting in Brussels, November 3, 2011, Mihai Ursan, PhD., P.Eng.

## ADAPTIVE CONTROL SYSTEM WITH MODEL REFERENCE SYSTEM (AMFC)

Nebojša Joković<sup>1</sup>, Novica Jevtić<sup>2</sup>, Vojin Kerleta<sup>3</sup>, Ljubiša Josimović<sup>4</sup>  
<sup>1</sup>“Danieli”, Italia

<sup>2</sup>Hidraulic, d.o.o., Smederevo, Serbia

<sup>3</sup>University of Novi Sad, Technical Faculty “Mihajlo Pupin”, Zrenjanin, Serbia

<sup>4</sup>Textile High School of Professional Studies, Leskovac, Serbia

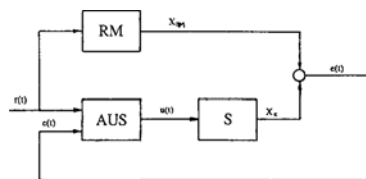
**Abstract:** The problem of adaptive control of electrohydraulic system is discussed in chapters: servovalve controlled piston, model – reference adaptive control system (AFMC), simulation, experimental researches.

**Key words:** adaptive control, electrohydraulic system,

### INTRODUCTION

Electrohydraulic servosystems are installed in a various devices and control a great number of processes in the industry. In a many processes are existed disturbances which are hardly predictable and which effect significantly on the characteristics of the systems. For a high-quality process control it is necessary to determine exact static and dynamic characteristics of a process, which unfortunately is not ever possible. Working conditions of the system are changed very often or characteristics of the system are changed from time to time. These are the reasons that a conventional control systems as PID-regulators can not satisfy demand tasks. Adaptive control systems can solve these problems. In this work a synthesis of the adaptive control system is done according to a method which is developed by J.S. Yun and H.S. Cho in literature [1] and which is based on Calman's, Bertram's and Monopoli's works. We use adaptive control system with model reference system (AMFC). Liapunov's direct method for a nonlinear systems is applied for a synthesis. In the hydraulic control systems for the position regulation very often is assumed that the system is without external disturbances, which very often is not correct(for example-rolling force on rolling stands is changeable with change of deformation resistance). Once a servovalve is built,the actual response will vary with operating conditions as supply pressure,input signal level,hidraulic fluid temperature...

### MODEL-REFERENCE.ADAPTIVE CONTROL SYSTEM (AFMC)



**Figure 1.** Model- reference adaptive control system

We can conclude from the figure 1 that it is necessary to define the reference model which (for the given reference entry  $r(t)$ ) creates demand reference model exit  $x_M(t)$ . In the model-reference control system, the output of the model and the output of the plant are compared and the difference is used to generate the control system activity. It is desired that the control system follow closely some model system. Our design problem here is to synthesize a controller that always generates a signal that forces the plant state toward the model state. We shall assume that the model-reference system is linear and described by equations:

$$\dot{x}_m = A_m x_m + b_m r$$

where:

$$A_m = \begin{pmatrix} 0 & 1 \\ -K_\omega & -K_\xi \end{pmatrix} \quad b_1 = \begin{pmatrix} 0 \\ K_\omega \end{pmatrix}$$

where:

$$K_\omega = \omega_m^2$$

$$K_\xi = 2\xi_m \omega_m$$

We choose values of coefficients  $K_\omega$  and  $K_\xi$  to obtain the demand response of the system. When we determine these coefficients then we can identify matrix  $A_m$  and vector  $b$ . We assume that the eigenvalues of  $A_m$  have negative real parts so that the model-reference system has an asymptotically stable equilibrium state. Let us define the error vector  $e$  by  $e = x_m - x$ . In the present problem, we wish to reduce error vector to zero by a suitable control vector  $u$ . A convenient starting point in the synthesis of the control vector  $u$  is the construction of a Liapunov function for the system given by equation (1). Let us assume that  $Q$  is a positive-definite matrix. Since the eigenvalues of  $A_m$  are assumed to have negative real parts then the solution of the Liapunov matrix equation  $PA_m + A_m^T P = -Q$  (2) is positive-definite matrix  $P$ . Let us assume that the form of the Liapunov function is given by equation (3):

$$\dot{e} = A_m e + b_m r - bu + (A_m - A)x \tag{1}$$

$$PA_m + A_m^T P = -Q \tag{2}$$

$$v(e) = e^T P e \tag{3}$$

where  $P$  is positive-definite symmetric matrix. System will be asymptotically stable if the first derivative of the Liapunov equation  $v$  is negative-derivate for the every values of  $e$ . Taking the derivative of  $v(e)$  with respect to time gives equation (4):

$$\dot{v}(e) = -e^T Q e + 2e^T P (b_m r - bu + (A_m - A)x) \tag{4}$$

The assumed  $v(e)$  function is a Liapunov function if:

1. Matrix  $Q$  is a positive -definite matrix
2. The control vector  $u$  must be chosen to make the second part of equation (4) nonpositive.

If the matrix  $A$  and vector  $b$  are known, then exists control  $u$  determined by equation (4) which enable that the  $e \rightarrow 0$  when  $t \rightarrow \infty$  and then equilibrium state  $e \rightarrow 0$  is asymptotically stable in the large. However the matrix  $A$  and the vector  $b$  are not known in this case. It is necessary to realize the negative-definition of the function  $v$  in a different way. According to last equations we obtain equation (5):

$$\dot{v}(e) = -e^T Q e + 2f_e (g_e - \theta_2 u) \tag{5}$$

where :

$$g_e = K_\omega r - K_\omega x_1 - (K_\xi - \theta_1)x_2 + \frac{F_s}{M}$$

$$f_e = p_{12}e_1 + p_{22}e_2$$

External force  $F_s$  is the greatest force which the hydraulic system can create with the given supply pressure. The second member of the right side of the equation (5) is negative-definite if the control signal  $u$  is defined by equation (6):

$$u = \frac{1}{\theta_{2_{\min}}} |g_e|_{\max} f_e \tag{6}$$

where:



$$-|g_e|_{\max} = K_\omega |r| + K_\omega |x_1| + |K_\xi - \theta|_{\max} |x_2| + \left| \frac{F_s}{M} \right|_{\max}$$

Since  $\theta_1 \gg K_\xi$  we can change  $|K_\xi - \theta|_{\max}$  with  $|\theta_1|_{\max}$ . This enables asymptotically stability of equilibrium state of the system. Block diagram of adaptive system is shown in figure 2.

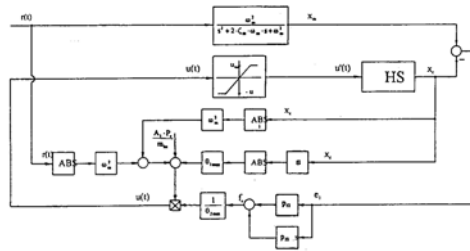


Figure 2. Block diagram of the model-reference control system

For the complete determination of the control it is necessary to determine parameters  $\theta_{1\max}, \theta_{2\max}, \left| \frac{F_s}{M} \right|_{\max}$  and matrices P and Q. Therefore we can write equations (7) :

$$\theta_{1\max} = \left( \frac{[A_1(1+\gamma)]^2}{4M(c_u + K_{c\min})} - \frac{B_c}{M} \right) \Big|_{M=cic}$$

$$\theta_{2\max} = \frac{A_1(1+\gamma)K_{sv}}{2M(c_u + K_{c\max})} \quad (7)$$

Maximum and minimum values of the flow gain and the flow –pressure coefficients we can determine by the following analysis. Quotient of the difference of pressures in the chambers of hydraulic cylinder and the supply pressure is:

$$\frac{|p_L|}{p_s} \leq C_k$$

where  $C_k$  is positive number smaller than 1. According to the definition of the coefficients we can write equations (8):

$$K_{q\min} = c_d w \sqrt{\frac{1}{\rho} p_s (1 - C_k)}$$

$$K_{q\max} = c_d w \sqrt{\frac{1}{\rho} p_s (1 - C_k)} \quad (8)$$

$$K_{c\min} = 0$$

$$K_{c\max} = \frac{c_d w x_{v\max}}{2\sqrt{\rho P_s (1 - C_k)}}$$

According to design parameters of the system ( $A_1, A_2, M, \dots$ ) and coefficients determined by equations (8) we can determine values.

Since value of the external force must be smaller than maximum force on the hydraulic cylinder piston rod we can write :

$$\left| \frac{F_s}{M} \right|_{\max} \leq \frac{A_1 P_s}{m_{cil}}$$

Matrix Q must be positive-definite symmetric matrix:

$$q_{11} > 0$$

$$\det Q = q_{11}q_{22} - q_{12}^2 > 0$$

Where  $q_{ij}$  are elements of the matrix  $Q$ . According to Liapunov equation we obtain equation (9) :

$$P = \frac{1}{2K_{\omega}K_{\xi}} \cdot \begin{bmatrix} q_{11}K_{\xi}^2 - 2q_{12}K_{\omega}K_{\xi} + (q_{11} + q_{22}K_{\omega})K_{\omega} & q_{11}K_{\xi} \\ q_{11}K_{\xi} & q_{11} + q_{22}K_{\omega} \end{bmatrix} \quad (9)$$

Matrix P must be a positive-definite, symmetric matrix:

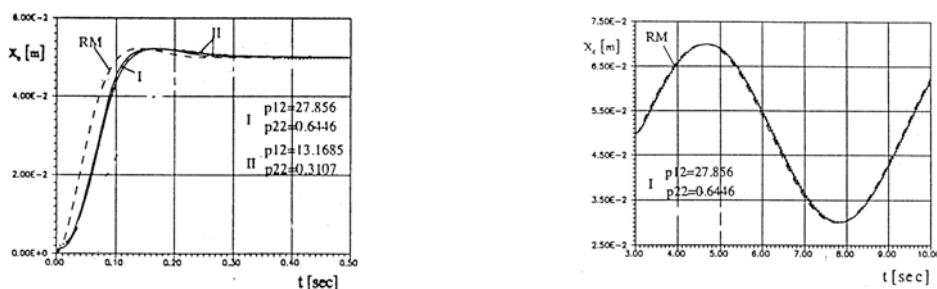
$$p_{11} = \frac{1}{2K_{\omega}K_{\xi}} \cdot [q_{11}K_{\xi}^2 - 2q_{12}K_{\omega}K_{\xi} + (q_{11} + q_{22}K_{\omega})K_{\omega}]K_{\omega} > 0$$

$$\cdot \left\{ (q_{11} + q_{22}K_{\omega})^2 + q_{11}q_{22}K_{\xi}^2 \right\} K_{\omega} - \left\{ -2q_{12}K_{\omega}K_{\xi}(q_{11} + q_{22}K_{\omega}) \right\} > 0 \quad (10)$$

For the application of the adaptive control it is necessary to chose coefficients of reference model and matrix  $Q$  to satisfy conditions (8) and (9). According to equation (10) we can determine values of  $p_{12}$  and  $p_{22}$ .

## SIMULATION

Nonlinear mathematical model of electrohydraulic system (consist of servovalve and hydraulic cylinder) is given in literature [4]. According to equation and figures 1 and 2 the entry in the electrohydraulic servosystem  $u(t)$  is formed from reference entry  $r(t)$ , hydraulic cylinder piston position  $X_c$ , exit from reference model  $X_m$  and derivates of  $X_c$  and  $X_m$ . According to many simulations we obtained the values of coefficients of matrix  $Q$  which give good work of the system. We will give only two samples which are characteristic for the system work. This samples are named as I and II. It satisfy conditions and realize stability of the equilibrium state of the system. At the figure 3a. The bouncing reaction of the system at entrance  $v = 0.05$  m, is presented at picture 3a), while the reaction on snie hange of desired value is presented at picture 3b).



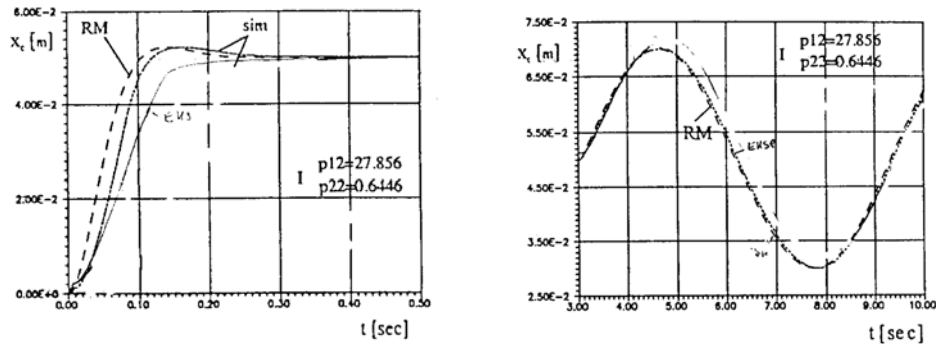
**Figure 3a.** Bouncing reaction of the system at entrance  $v = 0.05$  m

**Figure 3 b.** Reaction on snie hange of desired value

It's obvious from picture 3a) and 3b) that electrohydraulic system follows the change of desired value very well – the position of piston of hydraulic cylinder.

## EXPERIMENTAL RESEARCHES

The position of piston of hydraulic cylinder and exit value from referential pattern are measured at experimental measuring.



**Figure 4a.** Experimental measuring of the position of piston of hydraulic cylinder

**Figure 4b.** Experimental measuring of exit value from referential pattern

It's obvious from picture 4a) and 4b) that electrohydraulic system follows the change of desired value very well and results obtained on the basis of simulation and experiments are precisely in agreement.

## CONCLUSION

The advantage of this type of adaptive management of electrohydraulic system is that doesn't demand solving of linear and non – linear equations at every moment. The advantage is also that only with help of summators, multipliers, differentiators and elements for absolute value and with measuring only entrance  $r(t)$ ;  $X_c(t)$  and  $X_m(t)$  carries out all structure of this type of management. The calculating of matrixes  $Q$  and  $P$  is also easier to methods at which is calculated for example their own matrixes' vectors.

It should be emphasized that this working method provide asymptomatic stability but good results are also obtained at other working moments.

## REFERENCES

- [1] Yun J.S.CHO.H.S "Application of an adaptive model following control technique to a hydraulic servo systems subjected to unknown disturbances" ASME Journal of DSMC ,vol 113.1991.
- [2] Merrit H, "Hydraulic control systems" John Wiley and sons, Inc. 1967.
- [3] Adamovic Z, Maintenance of the Oilhydraulic systems, Belgrade, 1997.
- [4] Ampsefidis, A.J., Bialasiewicz J.T., Wall, E.T., Lyapunov design of a new model reference adaptive control system using partial a priori information, Kybernetika, Vol.29 (1993), No 4, p. 337 - 348

## WATER METERS

**Nikola Nikolić, Nenad Dajić**

<sup>1</sup>University of Novi Sad, Technical Faculty "Mihajlo Pupin", Zrenjanin  
e-mail: roker70@gmail.com

**Abstract:** The problem of this research is the development of modern water meters in both PCD and those that are used in households, their role in improving the accuracy of reading the flow of water as well as the way in which they could improve. Author of this paper aims to demonstrate the principles of functioning water meters and his solution to the problems of direction of water flow in them. Continuous investment in research and development enable the emergence of new instruments that can be easily integrated into existing systems automation.

**Key words:** water meters, industry

### INTRODUCTION

In more or less of all aspects of life and work a man is surrounded by installations and systems that flows through - or spend a fluid (in industry, households, travel, school, health, sports, military, and other facilities, etc.). These are usually cold or hot water, steam, natural or other gas, air, refrigerant, and some others. [1]

Fluid whose flow or speed is measured, can be gases, liquids or liquids mixed with solid ingredients. In the industry, converters and instruments to measure flow are often integral parts of the process controller or belong to systems for automatic control by computer. In the area of water supply (drinking water, irrigation, wastewater disposal ...), liquid or gaseous fuels, flow rate meters are essential parts of the meter, which is measured by the amount of fluid past. Given that it is about managing the demanding processing industry and/or collection of large sums of money, it is clear that the flow meters requires very high accuracy and reliability.

Plant safety, product quality, process optimization and environmental protection are key factors of each measured place.

Applications of flow meters are in all areas of processing and chemical industries, food processing and pharmaceuticals where the hygienic conditions are of the utmost importance to the energy and oil industries that require robust and reliable devices, which are able to withstand extreme conditions.

Water meters are the cornerstone of commercial systems for water utilities throughout the world; revenue is directly derived from the, figures provided by meters. Despite this, little attention has been paid, in terms of selection, replacement period and return on investment, to the management and optimization of water meters. [3]

### MATERIAL AND METHODS

#### Overview

The number of water meters used by a municipality often runs into tens or hundreds of thousands. Ensuring that each of these meters is in a good operating condition and complies with the legal metrological requirements is not an easy task, and calls for a carefully planned and systematic meter management system. [2]

An effective meter management system needs adequate staff and financial resources. However, the cost of such a system is more than compensated for by the financial gains through higher efficiencies and lower apparent losses. It also aids the provision of a high level of service to consumers. [2]

It is no secret that the meter shows the consumption decline when rotated so that the water passes through it in the opposite direction.

To prevent theft recoverability of water and damage to companies involved in the distribution, I added a check valve to the existing water meter that only allows fluid flow in the right direction.

Water theft occurs extensively in the summer, when expressed in watering garden, garden, grass courts, etc... Or activities which have significant amounts of water, car wash, etc...

This behavior results in a waste arrogantly towards resources and harm to millions of dinars.

Another advantage of this patent is that in cases when repairing a leak on the network, when it is necessary to relieve the pressure in the installation, faulty check valve on the water heater with unscrupulous consumers, due to the pressure in the boiler, which in this case behaves like a tank, leaking hot water heater, which typically results in the melting of the plastic mechanism in the meter counter and even melting of HDPE pipes before promised, to the main line.

So, part of the maintenance company responsible for water supply: mains and connection to the "first" valve.

Repair of such damage leak is more complex than just regular leak because the HDPE pipes from years of thermal effects under pressure lost its measure, so the diameter is now larger than standard connector and does not fit to fitting.

Any such failure depends on the skills of workers in the field, because they have to find the way by heating and calibration to narrow HDPE pipes of the old measure.

Meter which have damaged the plastic measuring mechanism, is necessary to replace it, with the proper. It's still a big expense for companies that distribute water and maintain the system.

Since I work at Waterworks and Sewerage - Zrenjanin maintenance, all of this I personally had the opportunity to see and to repair such defects.

There are other solutions, in the form of plastic clamps, as well as additional security seals that are placed on the unions, but they were not functional, they are also expensive.



**Figure 1.** Water meter

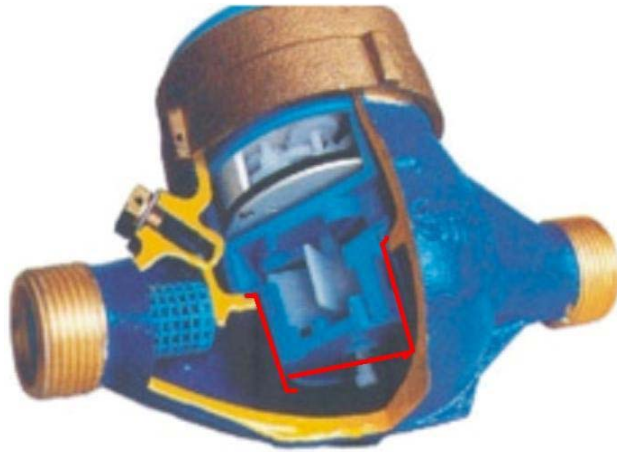


Figure 2. My solution of a backflow

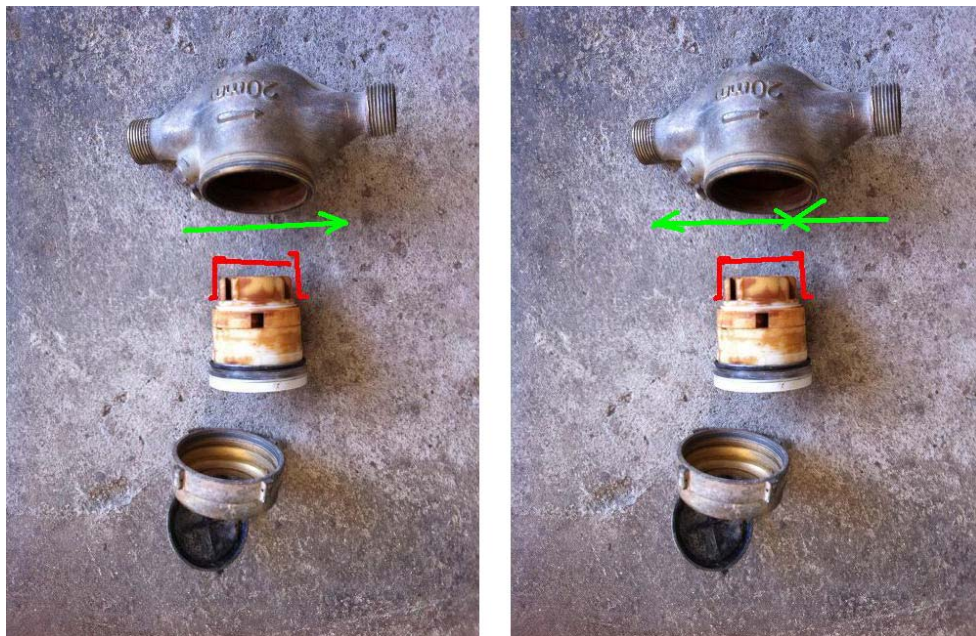


Figure 3. My solution of a backflow

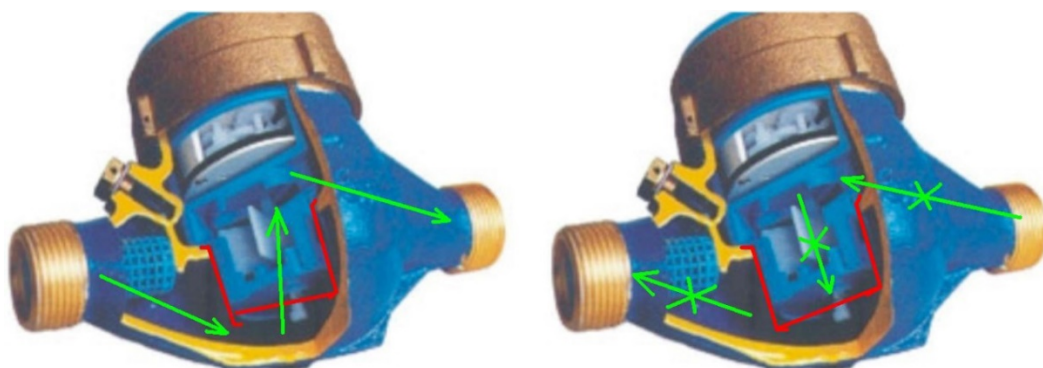


Figure 3. The direction of movement of fluid through the meter and check valve

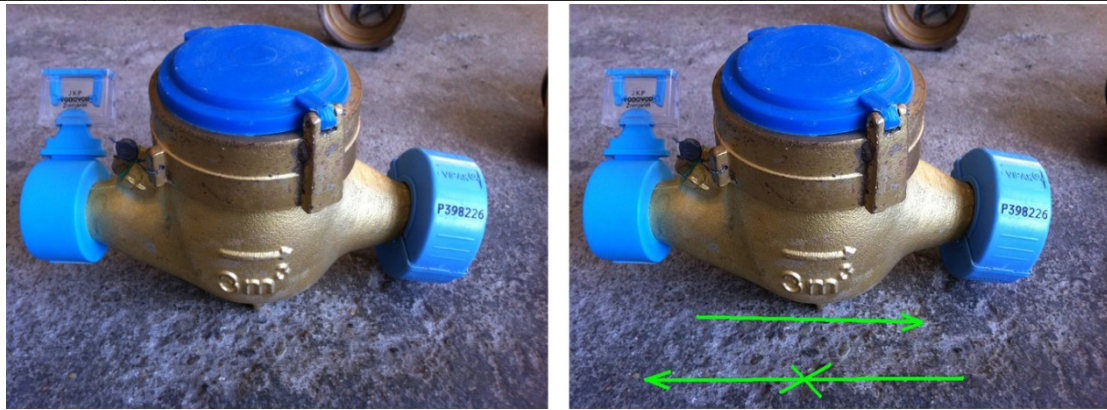


Figure 4. Additional plastic seals on unions



Figure 5. Additional plastic seals on unions – JKP Vodovod Zrenjanin

My solution for backflow preventer is a brass cylinder, hilsna that has flap valves with a rubber seal at the bottom, which by its weight closes the passage, as in artesian wells.

Flap as a selection valve has the advantage of not affecting the pressure drop and the flow of fluid through the meter, there are no springs to fatigue eventually and lose mechanical properties, and is made of brass, because it is water-resistant material, and water meter housing, and reparations are possible perspective.

Installation of the valve is extremely simple:

Mounted in brass casting, housing, the bucket that is already processed in a certain dimension, intended for installation plastic mechanism, before the mechanisms itself. The next phase is the installation of a plastic mechanism that is used to record and count water consumption.

This meter is calibrated at the end, ensuring seal and is ready to operate.

### Supplemented solution

There is another way to solve the same problem, and it is the valve assembly of the outer part of the water meter.

Specifically, it is necessary to commit the thread and mount support (sic), which will rest against the rubber sealing of valve core, valve fitted with spring wrap at the end of the guide valve core, which is also the holder of the second end of the spring.

This mechanism may be obtained from check valve that attaches to the water heater, you just need to contact the manufacturer of valves, because the measures are very similar and the technical solution is similar.

This significantly reduces the costs of the part that is installed, and hence the modification of the meters, which results in a minimum correction of the water meters price.

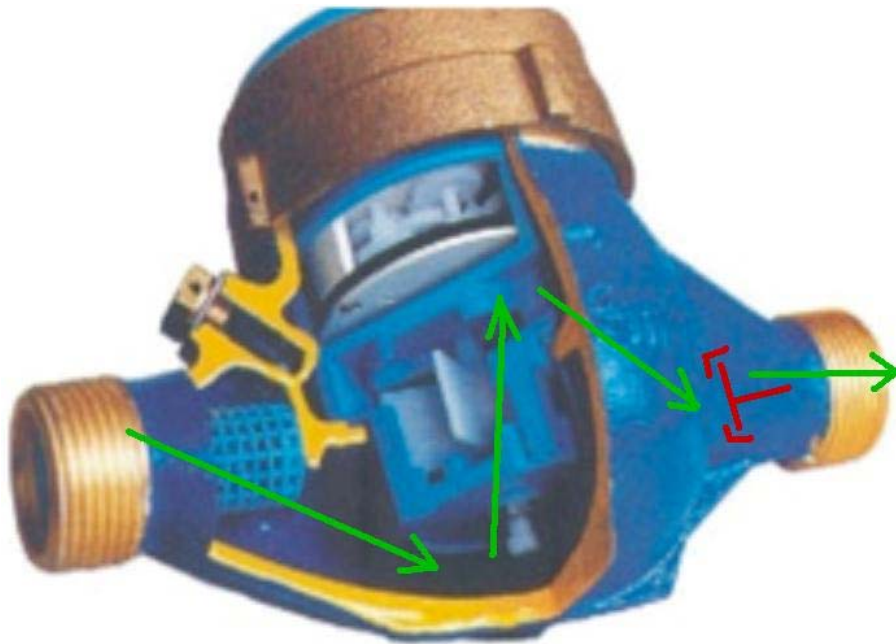


Figure 6. Another solution - check valve - open

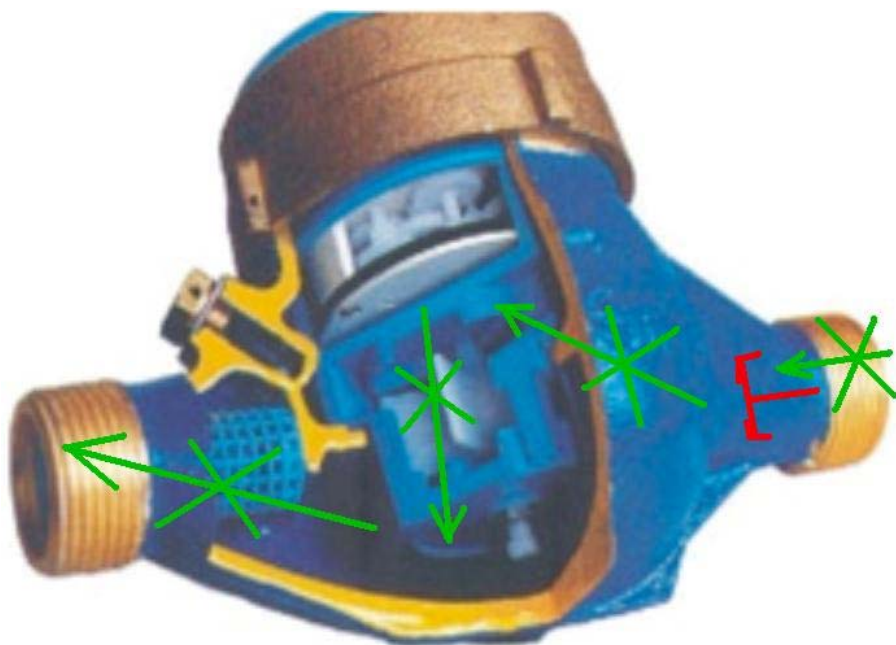


Figure 7. Another solution - check valve - closed



## RESULTS AND DISCUSSION

The advantage of this second solution is that when a faulty boiler check below, due to reduced or non-existent pressure in the network while the equally repair the leak, or water supply network is burdened by excessive exploitation (intensive watering garden in the wider area, by more users - in rural or suburban areas), additional non-return valve in the meter will prevent the penetration of water into hot water meter at the entrance, so that the plastic mechanism in a brass case gauge stays cold or lukewarm, not thermally loaded.

## CONCLUSION

Measuring the flow of liquids, vapors and gases is often measurement in industrial processes, water and thermal power plants and homes. It is very important in many industrial applications. Particularly significant are accounting measurements, because of the price of gas and liquid determined by the flow through the tube.

The math is quite simple: the state has eight million, the average household has four members, which is two million households...

Each household give only one euro at average to damage dealers, a significant amount of money annually.

A neighboring countries, the world?

## REFERENCES

- [1] Bašta T. M., Mašinska hidraulika, Naučna knjiga, Beograd, 1972.
- [2] Je Van Zul, Introduction to integrated water meter management, edition 1, 2011.
- [3] Arregui F., Cabrera E., Cobacho R., Integrated Water Meter Management, IWA Publishing, 2006.

## **SESSION 7: Computer Technologies and Engineering Education**

## CAD 3D MODELING OF SPUR GEAR WHEELS WITH LINEAR CHANGE OF THEIR PROFILE SHIFT COEFFICIENT ALONG THE TOOTH'S LENGTH

Dimitar Petrov, Dimitar Dimitrov

Technical University - Sofia, Branch Plovdiv, Plovdiv, Bulgaria

e-mail: [dimgog@abv.bg](mailto:dimgog@abv.bg), [ddimitrov\\_tu@abv.bg](mailto:ddimitrov_tu@abv.bg)

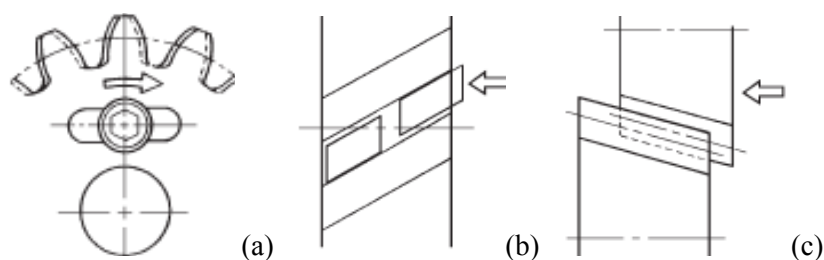
**Abstract :** In the Introduction methods for reducing backlash in mechanical tooth gears are briefly described – in particular one such method for using unusual spur gears (the so-called “conical involute gears”). In this work, an original methodology of creation 3D models of such unusual spur gear wheels is revealed. Those gear wheels have linear change of the profile shift coefficient along the tooth's length and their 3D models are created by means of one CAD software product of middle class. It is shown that the software tool "Equations" of that software gives possibilities for automation of the generation of such spur gear wheels with different tooth number, module, profile shift coefficient, etc.

**Key words:** 3D model, CAD, conical involute gear, profile shift coefficient

### INTRODUCTION

In robotics, in measuring instruments, in industrial machines for assembly, in precise engineering and in many other areas and fields reversible and cyclic mechanisms and machines are used. Their wide range of applications raises the issue of reducing the backlash errors from gaps into joints and into gears. Two methods to reduce or eliminate backlash are applied in mechanical tooth gears – a static and a dynamic method [1]. The static method concerns means of assembling gears and then making proper adjustments to achieve the desired low backlash. The dynamic method introduces an external force which continually eliminates backlash regardless of rotational position. The static method involves an adjustment of either the gear's effective tooth thickness (gear size) or the mesh center distance. The dynamic method is related to the static techniques but it involves a forced adjustment of either the effective tooth thickness (gear size) or the center distance.

One approach [2] to reducing the backlash in gear mechanisms is the use of the so-called “conical involute gears”. Due to the linear change of the profile shift coefficient  $x$  in the face sections, in these “conical involute gears,” spur wheel tooth thickness on the pitch circle also varies linearly and axially from one end to the other. In fact, this approach involves the use of cone shaped gears [1], such as bevel and tapered tooth spur gears and backlash can be adjusted with axial positioning – Figure 1(c).

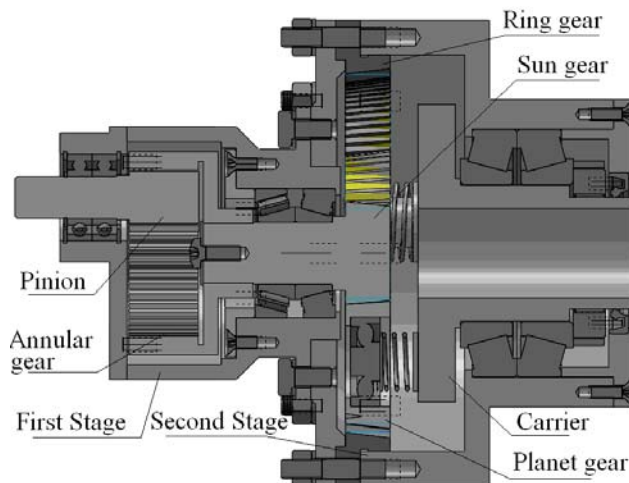


**Figure 1.** Ways of reducing backlash in the case of fixed center distance and adjustable gear size: (a) – Rotary Adjustment; (b) – Parallel Adjustment; (c) Axial Adjustment.

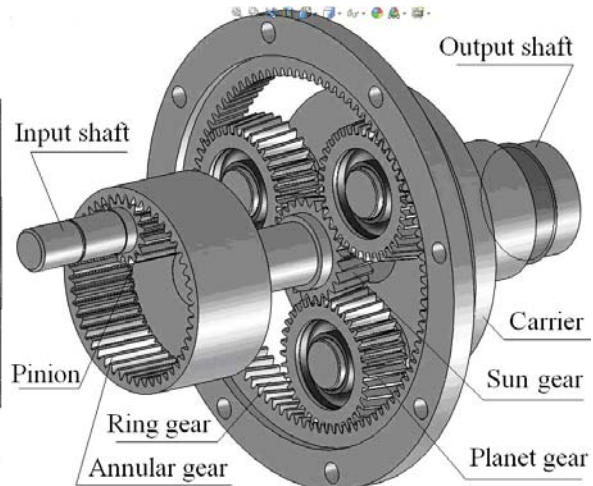
In order to investigate and manufacture this type of gear wheels with linear change of the profile shift coefficient along the tooth's length, we needed to make three dimensional models of gear wheels in the environment of computer aided design (CAD). Currently, there are many software tools for automated design in engineering. Those of high-class but also those of middle class have specialized modules for automated design of specific machine elements - keys, splines, bolts, etc., and gears as well. However, these modules could generate only standard spur gear wheels, so we had to develop our own 3D models of “conical involute gears”. This article describes our methodology of creating 3D models of spur gear wheels with linear change of the profile shift coefficient along the tooth's length.

## SHORT DESCRIPTION OF ORIGINAL MECHANICAL GEAR WITH ADJUSTING OF THE BACKLASH

The proposed original mechanical gear (Figure 2) has two stages – the first stage is an ordinary spur gear with internal meshing while the second stage is a planetary mechanism with spur gear wheels with linear change of the profile shift coefficient along the tooth's length (in short “conical involute gear wheels”). In the first stage the backlash is adjusted by means of changing the center distance (in other words – using the static method). In the second stage the backlash is adjusted by means of axial pressing of conical involute planet gear wheels by means of springs towards the opposite faced conical central sun gear wheel and central ring gear wheel (in other words - using the dynamic method).



**Figure 2.** Mechanical gear with adjusting of the backlash

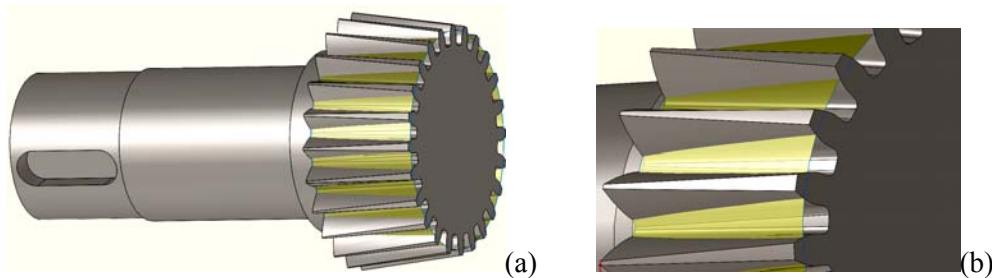


**Figure 3.** Mechanical gear with adjusting the backlash - only gear wheels & shafts are showed

In Figure 3, another view of the described mechanical gear without housings, bearings, gaskets, screws, etc. is shown. The input shaft has a pinion with 16 teeth and module  $m = 1.5$  mm. The internal gear wheel of the first stage of this mechanical gear, which is meshed with pinion, has 48 teeth. The second stage is implemented as a simple planetary gearing with one sun gear, one immovable ring gear and a set of 3 planet gears which are mounted on a movable arm (carrier) which can itself rotate relative to the sun gear. The sun gear wheel has a number of teeth  $z_s = 24$ , an immovable ring gear –  $z_r = 96$  and planet gear wheels -  $z_p = 36$ . The teeth module in second stage is  $m = 1.5$ .

## METHODOLOGY OF MODEING OF CONICAL INVOLUTE SPUR GEARS

The methodology of 3D model generation of "conical involute spur gear wheels" is shown on the basis of the 3D model's creation of the sun gear wheel because that wheel has the smallest teeth number in the planetary gearing. The small number of teeth leads to a more visible change of the shape of teeth with changing shift coefficient. It also limits the range of possible change of that coefficient.



**Figure 4.** 3D model of shaft & sun gear wheel: (a) - shaft, (b) – teeth of the sun gear wheel.

In Figure 4 the 3D model of the sun gear wheel of the discussed mechanical gear unit is shown. The wedge-shaped teeth are clearly seen. The sun wheel is a spur gear wheel which has linearly and axially

(axially to the shaft) changing coefficient of profile shift from negative value ( $x_m = -1.064$ ) on the right end of the shaft to positive value ( $x_p = +0.4$ ) to the left. This leads to a linear increase of the width of the teeth on the pitch cylinder from right to left.

The shift coefficient ( $x_m = -1.064$ ) on the right end is the smallest possible coefficient without undercutting of teeth for that teeth number  $z_s = 24$ . Similarly, the shift coefficient ( $x_p = +0.4$ ) on the left is the biggest possible coefficient for permissible reducing of the thickness of the tip of teeth.

3D models are generated in the environment of CAD software product SolidWorks. This software product possesses an advanced tool *Equations* by means of which it is possible to set relationships between elements of geometry mathematically and introduce global variables. This allows us to make the models as close as possible to the real and reshape them by setting new values for parameters such as number of teeth  $z$ , module of teeth  $m$ , pressure angle  $\alpha$ , profile shift coefficient  $x$ , etc.

After opening the New SolidWorks Part document, the modeling begins with the generation of the basic sketch (Figure 5) on Front Plane for cross section with profile shift coefficient  $x = 0$ . In conditions of this generation and after the activation of *Equations* (under the menu *Tools*) the global variables are introduced - number of teeth  $z$ , module of teeth  $m$ , pressure angle  $\alpha$ , profile shift coefficient  $x$  and as global constants the coefficients: of addendum  $h_a^* = 1,0$ , of dedendum  $h_f^* = 1,25$ , of fillet radius  $\rho_a^*$  etc. Then, the standard pitch circle, the base circle, the addendum and the dedendum circles are drawn. Their diameters are determined by means of the tool *Equations* as follows [3], [4]:

$$d = z \cdot m$$

$$d_b = d \cdot \cos(\alpha)$$

$$d_a = m \cdot (z + 2 \cdot h_a^* + 2 \cdot x)$$

$$d_f = m \cdot (z - 2 \cdot h_f^* + 2 \cdot x)$$

Where:  $m = 1.5$ ,  $z = 24$ ,  $x = 0$ ,  $\alpha = 20 \text{ deg}$ ,  $h_a^* = 1$ ,  $h_f^* = 1.25$ .

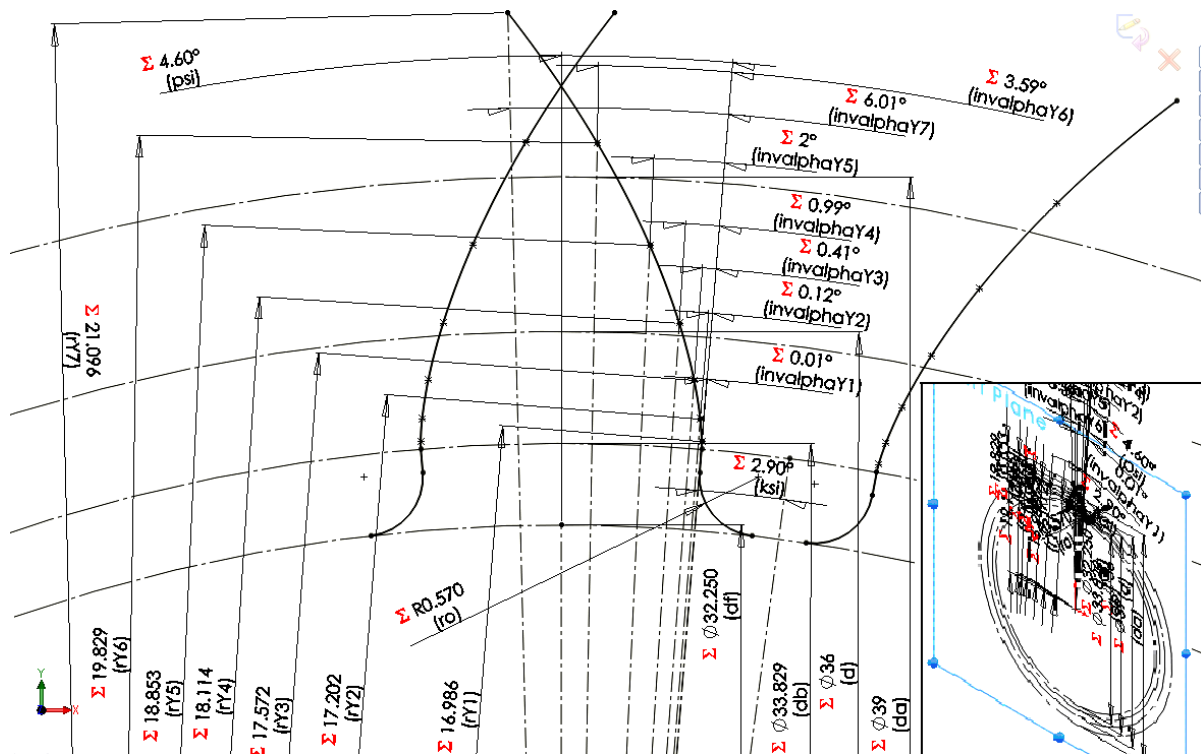


Figure 5. Basic Sketch1.

In Figure 6 the introduced global variables (as "z" – teeth number, "m" – module, "alpha" – profile angle, "p" – circular pitch, "d" – diameter of standard pitch circle, "db" – diameter of base circle, "s" – tooth thickness at standard pitch circle, "sb" - tooth thickness at base circle, etc.) and *Equations* controlled dimensions which are needed (as "d@Sketch1", "db@Sketch1", "da@Sketch1" – diameter of addendum circle, "df@Sketch1" – diameter of dedendum circle, etc.) for Sketch1 can be seen.

Active	Equation	Evaluates To	Comment
✓	1 "z"=24	✓ 24	Number of Teeth
✓	2 "x"=0	✓ 0	Profile Shift Coefficient for basic Sketch 1
✓	3 "m"=1.5	✓ 1.5	module of teeth mm
✓	4 "alpha"= 20	✓ 20	Standard Profile Angle in degrees
✓	5 "p"="m" * pi	✓ 4.71239	circular pitch at pitch diameter in mm
✓	6 "d"= "z" * "m"	✓ 36	Diameter of Pitch Circle, mm
✓	7 "db"= "d" * cos( "alpha" )	✓ 33.8289	Diameter of Base Circle in mm
✓	8 "d@Sketch1" = "d"	✓ 36mm	Diameter of Pitch Circle for Sketch 1 in mm
✓	9 "db@Sketch1" = "db"	✓ 33.83mm	Diameter of Base Circle for Sketch 1 in mm
✓	10 "da@Sketch1" = "m" * ( "z" + 2 + 2 * "x" )	✓ 39mm	Diameter of the addendum circle for Sketch1 in mm
✓	11 "df@Sketch1" = "m" * ( "z" - 2.5 + 2 * "x" )	✓ 32.25mm	Diameter of the dedendum circle for Sketch1 in mm
✓	12 "x_p"=1.064	✓ 1.064	Max Profile Shift Coefficient (Positive) for Sketch9 and Sketch11

Figure 6. Equations table - first 12 equations and global variables.

Then, the involute as a spline line through  $n$  points is generated, beginning from a point of the base circle (Figure 5), which lies at an angle  $\psi@Sketch1$  (see Figure 5 and Figure 8- row 22) with respect to the vertical axis. In general, this is done in the following way: - the profile angle  $\alpha_{amax}$  (see "alphaYmax" at row 14 on Figure 7) which corresponds to the addendum circle of cross section of sun gear corresponding to maximal profile shift coefficient (here  $x_p = + 0.4$  for the leftmost cross section on Figure 4) is determined, this angle is divided into  $n$  equal intervals in order to determine the step of increasing  $\Delta\alpha_a$ , this step is used in a FOR ... NEXT  $i$  cycle in order to calculate the polar coordinates ( $inv \alpha_i, r_i$ ) of consecutive  $i$ -points of the involute by the formulas (see equations 23 to 36 in Figure 8):

$$\alpha_{amax} = \arccos(d_b/d_a)$$

$$\Delta\alpha_a = \alpha_{amax}/n$$

FOR  $i=1$  TO  $n$

$$r_i = d_b / (2 \cdot \cos(i \cdot \Delta\alpha_a))$$

$$inv \alpha_i = [tg(i \cdot \Delta\alpha_a) - (i \cdot \Delta\alpha_a) \cdot \pi / 180] \cdot 180 / \pi$$

NEXT  $i$

Active	Equation	Evaluates To	Comment
✓	13 "da_p"= "m" * ( "z" + 2 + 2 * "x_p" )	✓ 42.192	Diameter of the addendum circle for Sketch9 in mm
✓	14 "alphaYmax"= arccos( "db" / "da_p" )	✓ 36.6991	Maximum angle of unwinding of generating cord of the invol...
✓	15 "delta_alpha"="alphaYmax" / 7	✓ 5.24272	Fixed Step of unwinding of generating cord of the involute i...
✓	16 "e"= pi * "m" / 2 - 2 * "x" * "m" * tan( "alpha" )	✓ 2.35619	Tooth Space at the pitch circle in mm
✓	17 "pb"= "p" * cos( "alpha" )	✓ 4.4282	Base Pitch at base diameter in mm
✓	18 "s"= pi * "m" / 2 + 2 * "x" * "m" * tan( "alpha" )	✓ 2.35619	
✓	19 "invalpha"=( tan( "alpha" ) - "alpha" * pi / 180)	✓ 0.0149044	angle involjuta_alpha for radius equal to half d in radians
✓	20 "sb"="db" * ( "s" / "d" + "invalpha" )	✓ 2.7183	
✓	21 "eb"="pb" - "sb"	✓ 1.7099	Tooth Space at the base circle in mm

Figure 7. Equations table - equations 13 - 21.

The involute is stretched through these points. Then, the fillet is drawn between the involute and a dedendum circle with radius  $\rho = \rho_a^* \times m = 0.38 \times m$  (see row 37 on Figure 9). After that a mirror image of both the involute and its fillet is made about a line that divides tooth thickness equally. The mirror line on Figure 5 is the vertical line which passes through the center. The original and mirror evolutes and fillets will help to extrude the first tooth. If we want to cut tooth space, then we will need to form the third involute and its fillet, which are mirror image of originals about a line which is at an angle  $\psi@Sketch1 + \kappa@Sketch1$  (see Figure 9 – row 38) with respect to the vertical line (Figure 5). After closing the editing of basic Sketch1, two new planes (Plane 1 and Plane 2), parallel to and on different sides of the Front plane, are generated (Figure 11). The distance between them is the face-width of the sun gear. Sketch10 with addendum and dedendum circles for maximal negative profile shift is created on Plane 1. Analogically, Sketch 9 with addendum and dedendum circles for maximal positive profile shift is created on Plane 2.

22	"psi@Sketch1" = (( "sb" / 2 ) / ( "db" / 2 ) ) * 180 / pi	✓	4.6deg	angle between first point of elolute and...
23	"invalphaY1@Sketch1"=( tan( 1 * "delta_alpha" ) - 1*"delta_alpha" * pi /180)*180/ pi	✓	0.01deg	step01,polar coord.-angle,deg
24	"rY1@Sketch1" = ( "db@Sketch1" / 2 ) / cos( 1 * "delta_alpha" )	✓	16.99mm	First step, polar coordinate - radius, mm
25	"invalphaY2@Sketch1"=( tan( 2 * "delta_alpha" ) - 2*"delta_alpha" * pi /180)*180/ pi	✓	0.12deg	step02,polar coord.-angle,deg
26	"rY2@Sketch1" = ( "db@Sketch1" / 2 ) / cos( 2 * "delta_alpha" )	✓	17.2mm	Second step, polar coordinate - radius, mm
27	"invalphaY3@Sketch1" = ( tan( 3 * "delta_alpha" ) - 3*"delta_alpha" * pi /180)*180/ pi	✓	0.41deg	step03,polar coord.-angle,deg
28	"rY3@Sketch1" = ( "db@Sketch1" / 2 ) / cos( 3 * "delta_alpha" )	✓	17.57mm	Third step, polar coordinate - radius, mm
29	"invalphaY4@Sketch1" = ( tan( 4 * "delta_alpha" ) - 4*"delta_alpha" * pi /180)*180/ pi	✓	0.99deg	step04,polar coord.-angle,deg
30	"rY4@Sketch1" = ( "db@Sketch1" / 2 ) / cos( 4 * "delta_alpha" )	✓	18.11mm	Forth step, polar coordinate - radius, mm
31	"invalphaY5@Sketch1" = ( tan( 5 * "delta_alpha" ) - 5*"delta_alpha" * pi /180)*180/ pi	✓	2deg	step05,polar coord.-angle,deg
32	"rY5@Sketch1" = ( "db@Sketch1" / 2 ) / cos( 5 * "delta_alpha" )	✓	18.85mm	Fifth step, polar coordinate - radius, mm
33	"invalphaY6@Sketch1" = ( tan( 6 * "delta_alpha" ) - 6*"delta_alpha" * pi /180)*180/ pi	✓	3.59deg	step06,polar coord.-angle,deg
34	"rY6@Sketch1" = ( "db@Sketch1" / 2 ) / cos( 6 * "delta_alpha" )	✓	19.83mm	Sixth step, polar coordinate - radius, mm
35	"invalphaY7@Sketch1" = ( tan( 7 * "delta_alpha" ) - 7*"delta_alpha" * pi /180)*180/ pi	✓	6.01deg	step07,polar coord.-angle,deg
36	"rY7@Sketch1" = ( "db@Sketch1" / 2 ) / cos( 7 * "delta_alpha" )	✓	21.1mm	Seventh step, polar coordinate - radius,...

Figure 8. Equations table - equations 22 - 36.

The diameters of these circles are calculated by means of the *Equations* tool – see rows 40 and 41 in Figure 8 and rows 46 and 47 in Figure 9. A dedendum (root) truncated cone as a loft feature is generated between dedendum (root) circles of the two - Sketch9 and Sketch10.

37	"ro@Sketch1" = 0.38 * "m"	✓	0.57mm	fillet between involute and dedendum circle
38	"ksi@Sketch1" = ( ( "eb" / 2 ) / ( "db" / 2 ) ) * 180 / pi	✓	2.9deg	angle between first point of elolute and bicector for tooth space...
39	"x_m" = -0.4	✓	-0.4	Max Profile Shift Coefficient (Negative) for Sketch10 and Sketch12
40	"da_p@Sketch9" = "m" * ( "z" + 2 + 2 * "x_p" )	✓	42.19mm	Diameter of the addendum circle for Sketch9, mm
41	"df_p@Sketch9" = "m" * ( "z" - 2.5 + 2 * "x_p" )	✓	35.44mm	Diameter of the dedendum circle for Sketch9, mm
42	"s_p" = pi * "m" / 2 + 2 * "x_p" * "m" * tan( "alpha" )	✓	3.51799	
43	"sb_p" = "db" * ( "s_p" / "d" + "invalpha" )	✓	3.81003	Tooth Space at the base circle for Sketch9, mm
44	"psi_p@Sketch9" = ( ( "sb_p" / 2 ) / ( "db" / 2 ) ) * 18...	✓	6.45deg	angle between first point of elolute and bicector for Sketch9, deg
45	"eb_p" = "pb" - "sb_p"	✓	0.618...	Tooth space at base circle for Sketch9, mm

Figure 9. Equations table - equations 37 - 45.

Sketch9 and Sketch10 are also used for determining the angles of location of the involute curve in two different cross sections in comparison to the position of involute in basic Sketch1 – see Figure 11(b), Figure 11(c), Figure 9 (rows 42-45) and Figure 10(rows 48 - 51).

46	"da_m@Sketch10" = "m" * ( "z" + 2 + 2 * "x_m" )	✓	37.8mm	Diameter of the addendum circle for Sketch10, mm
47	"df_m@Sketch10" = "m" * ( "z" - 2.5 + 2 * "x_m" )	✓	31.05mm	Diameter of the dedendum circle for Sketch10, mm
48	"s_m" = pi * "m" / 2 + 2 * "x_m" * "m" * tan( "alpha" )	✓	1.91943	
49	"sb_m" = "db" * ( "s_m" / "d" + "invalpha" )	✓	2.30787	Tooth Space at the base circle for Sketch10 , mm
50	"psi_m@Sketch10" = ( ( "sb_m" / 2 ) / ( "db" / 2 ) ) * ...	✓	3.91deg	angle between first point of elolute and bicector for Sketch10, ...
51	"eb_m" = "pb" - "sb_m"	✓	2.12032	Tooth space at base circle for Sketch10, mm
52	"ro_p@Sketch11" = 0.38*"m"	✓	0.57mm	fillet between involute and dedendum circle - Sketch 11
53	"ro_m@Sketch12" = 0.38*"m"	✓	0.57mm	fillet between involute and dedendum circle - Sketch 12
54	"D1@Sketch9" = "psi_p@Sketch9"	✓	6.45deg	
55	"D2@Sketch9" = "psi_p@Sketch9"-"psi@Sketch1"	✓	1.85deg	angle shift of evolute for positive shift coefficient
56	"D1@Sketch10" = "psi@Sketch1"-"psi_m@Sketch10"	✓	0.7deg	angle shift of evolute for negative shift coefficient

Figure 10. Equations table - equations 46 - 56.

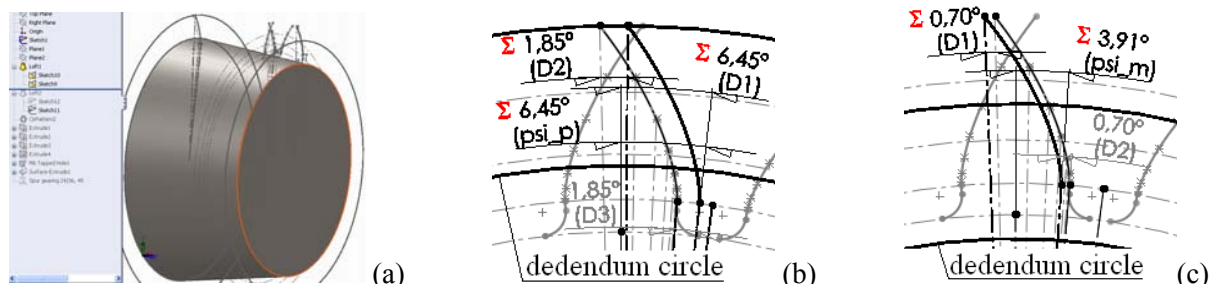


Figure 11. Root truncated cone of the sun gear-(a) & sketches (portions) Sketch9-(b) and Sketch10-(c).

Using the location of the evolutes from Sketch9 and Sketch10, the closed contours of a gear tooth are made by means of mirroring the evolutes and fillets, converting the addendum and dedendum circles and trimming unnecessary entities in Sketch 11 and Sketch12 – see Figure 12(a). These contours are used to generate one tooth by means of the "Loft" feature (see Loft2 in Figure 12(a)). Then all 24 teeth are created by means of the tool "Circular Pattern" – see Figure 12(b).

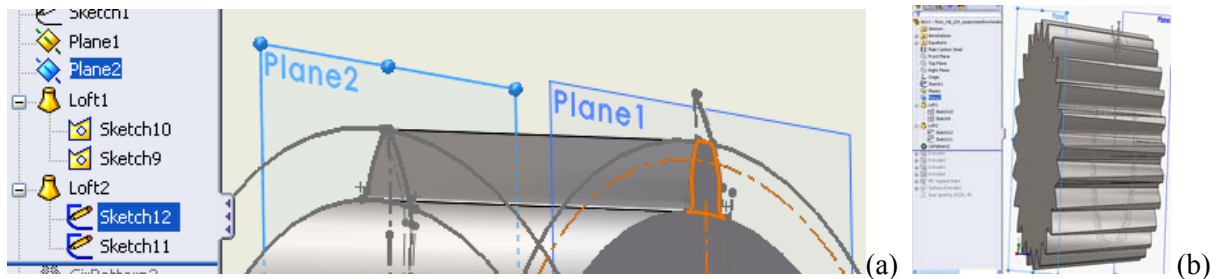


Figure 12. Creation of one tooth (a) and all teeth (b) of sun gear.

The rest features of the shaft are not unusual task – see figure 4(a).

## CONCLUSION

This work describes an original methodology for creating 3D models of unusual spur gear wheels, which have linear change of the profile shift coefficient along the tooth's length. The used CAD - software product has the features necessary for the generation of such 3-D models if its tools are used appropriately. The software tool *Equations* also gives the opportunity for automation of the generation of such spur gear wheels with different tooth number, module, profile shift coefficient, etc.

## REFERENCES

- [1] KOHARA GEAR INDUSTRY CO., LTD, Practical Information on Gears, [http://www.khkgears.co.jp/de/gear\\_technology/pdf/gear\\_guide2.pdf](http://www.khkgears.co.jp/de/gear_technology/pdf/gear_guide2.pdf), 2013.
- [2] Вейц В.Л., Кочура А.Е., Царев Г.В., Расчет механических систем приводов с зазорами, "Машиностроение", Москва, 1979.
- [3] Арнаудов К., Димитров И., Йорданов П., Лэфтеров Л., "Машинни елементи", Техника, София, 1980 г.
- [4] Николов Н., Димчев Г., Захариев К., Петров И., Маринов А., Арнаудов К., "Ръководство за конструктивни упражнения по машинни елементи", ISBN 954-03-0030-4, "Техника", София, 1992.
- [5] <http://www.mech.uwa.edu.au/DANotes/gears/failure/failure.html>.



## APPLICATIONS OF THE ADDITIVE MANUFACTURING TECHNOLOGY TO MANUFACTURE THE HIP IMPLANTS

Aleksandar Rajić<sup>1</sup>, Slobodan Stojadinović<sup>2</sup>, Dorian Nedelcu<sup>3</sup>,  
Eleonora Desnica<sup>2</sup>, Ljubica Lazić Vuličević<sup>1</sup>

<sup>1</sup>Technical College of Applied Sciences, Zrenjanin, Serbia

<sup>2</sup>University of Novi Sad, Technical Faculty "Mihajlo Pupin", Zrenjanin, Serbia

<sup>3</sup>"Eftimie Murgu" University of Resita, Romania

e-mail: [aleksandar.rajic@vts-zr.edu.rs](mailto:aleksandar.rajic@vts-zr.edu.rs)

**Abstract:** The paper presents an application of the Additive Manufacturing (AM) technology using a 3D Printer to manufacture hip implant patterns for investment casting process. The goal of the paper is to outline the manufacturing technology intended for prototype production with the use of PolyJet technology and investment casting technology for use in orthopaedics and the surgery of cemented hip joint replacement. At present the research is focused on the preparation of STL data and verification of the production technology of prototypes made using PolyJet technology. The procedure is defined within the work conducted in the international IPA Cross-border Cooperation Programme Romania - Republic of Serbia project where Rapid Prototyping (RP) technology was studied.

**Key words:** Additive Manufacturing, Rapid Prototyping, hip implant, investment casting, meltable wax model.

### INTRODUCTION

The most recent approaches to technological innovations include technological innovations of products and processes as competition factors as well as the new information and flexible manufacturing technologies having new properties. Modern development and design of new products and technologies is based on CAD/CAM/CAE technology application.

Additive Manufacturing (AM) is a procedure of direct prototype production by means of the gradual addition of individual material layers. The procedure, based on 3D CAD file, is relatively known nowadays. Additive Manufacturing technologies is the most frequently used name for a technology family: Rapid Prototyping (RP), Rapid Tooling (RT), Rapid Manufacturing (RM) and Reverse Engineering (RE).

When the application of AM technology started in investment casting, the parts produced within the first AM systems were applied as meltable wax models in order to shorten the time and costs of casting. Economic benefit which the AM meltable models provide is reduced to individual and small series production due to high AM material costs.

The latest researches in technology of development of AM meltable models are redirected to development and application of Rapid Tooling technology which ensures fast development of tools/molds for meltable wax models development in investment casting. The name Rapid Investment Casting (RIC) is RP and RT techniques application in investment casting. Additive Manufacturing technology is optimal for the process of custom implants. These are the reasons why AM technologies have such an important role in medicine.

### INVESTMENT CASTING OF METAL IMPLANTS

The main feature of technological process of producing cast products by investment casting is to inject under pressure an easily melted model mass in tools made of metal or other material: after solidifying in the tool the mass assumes the shape of a cast piece. The injecting system is made in other tool. The model of cast piece is joined to the injecting system model after it has been removed from the model tool. Since the models are of small dimensions, more models are joined for one injecting system which makes a wax sprue. Several layers of suspension are applied on the prepared wax sprue, which form a solid shell after drying. The shell is made by melting the model assembly and is then put into special boxes and sprinkled with sand or grains, [9].

The box containing the shell is heated in a furnace to a relatively high temperature and then is cast. After cooling down the cast pieces are removed from the shell and then detached from the injecting system and cleaned. If necessary, thermal treatment of cast pieces is performed. Investment casting is used for making cast pieces of ferrous, non-ferrous and light metals. Investment casting produces high quality and geometrically complex near net shaped metal parts with tight tolerances economically in case of mass production. The economic benefits of investment casting are limited to mass production. Limitations of traditional investment casting, [7]:

- traditional investment casting requires the production of metal tooling for the injection of wax material to produce sacrificial patterns which leads to cost justification problems for prototyping, pre-series, customized and single casting and small and medium quantity production.
- major part of the total lead time is consumed in production of metal tooling required for wax pattern generation.
- before committing to manufacturing, numbers of design iterations are performed by tool makers by evaluating different mould design which further incorporate an additional cost and lead time.

Metal orthopedic implants made of meltable models are hip prosthesis stem for cemented implantation and Fig. 1 shows tool for meltable-wax model and finished hip implant metal cast piece. The material of metal implants is CoCrMo alloy.



**Figure 1.** Tool for meltable implant model (left) and finished hip implant metal cast piece (right)  
(Courtesy of investment casting foundry – Livnica preciznih odlivaka Ada)

There are several companies producing medical implants using stainless steel alloys in the Serbian market. This production is mainly carried out by machining or forging. CoCr based alloys are used more in the area of hip joint replacements production in the foundry industry at present. CoCr alloys have been utilised for many decades in making artificial joints. They are generally known for their excellent wear resistance.

A very strict certification regarding the material quality causes problems to foundries. Hip implants are produced in different sizes, for the left and right hip separately. Producers are trying to satisfy each individual patient's needs at a surgery.

The term RIC represents the employment of AM techniques in investment casting. The cost involved in designing and fabrication of metal tooling for wax injection process can be overcome by using AM techniques to fabricate sacrificial patterns for investment casting. Additive manufacturing also facilitates to reduce the overall lead time involved in production of prototype casting with excellent quality. By employing AM-fabricated patterns to produce the prototypes, there is no need to commit to production tooling for single part or small quantity production, [1].

Additive Manufacturing techniques provide various cost effective solutions by which preseries casting can be produced very economically. Presently, almost all commercialised AM techniques have been employed to produce IC patterns with varying success and many AM solutions in investment casting are being used by various industries and researchers. The use of Additive Manufacturing in investment casting is in three basic forms. Fig. 2 shows the three basic approaches used as RC solutions in RIC.

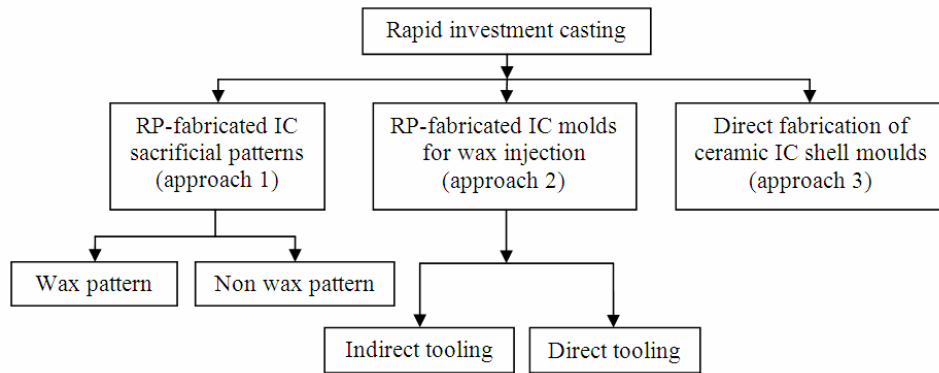


Figure 2. Rapid investment casting approaches [2]

### THE DESCRIPTION OF THE 3D PRINTER

Objet Geometries machines build parts layer by layer combining inkjet technology with photopolymerisation (UV curing) process, as shown in Fig. 3.

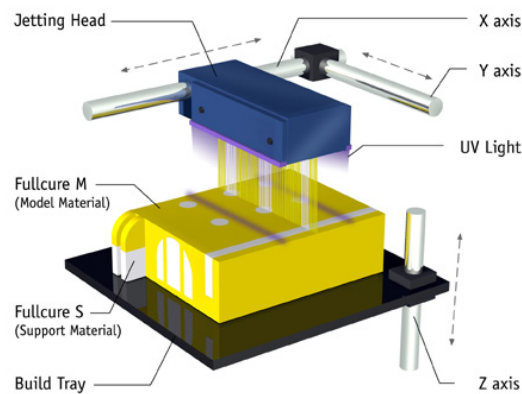


Figure 3. Polymer jetting printing process

Objet 3D Printer Multifunctional Desktop 30, Fig. 4, used in this study has maximum print size defined by the parallelepiped 294 mm x 192.7 mm x 148.6 mm, with a resolution of 600 dpi in the X, Y axis respectively 900 dpi in Z axis. The layer thickness on Z-axis direction is 28 microns. Accuracy can vary depending on the geometry, orientation and size of the object, up to 0.1 - 0.2 mm. The models do not require further finishing, but can still be processed by drilling, soldering, metal coating, painting. The wall thickness is 0.6 mm and minimum diameter of the holes is 1 mm.



Figure 4. Objet 3D Printer Multifunctional Desktop 30  
(Courtesy of Center for Numerical Simulation and Digital/Rapid Prototyping,  
University "Eftimie Murgu" Resita, Romania)

The range of material model (material used to print the full part of a model) available include Objet FullCure materials: VeroWhite, VeroBlue, VeroBlack, VeroGray, DurusWhite, TangoPlus, TangoBlack and FullCure®720. In this research was applied VeroBlack – FullCure870 material, and its properties are shown in Table 1.

**Table 1.** Material properties VeroBlack - FullCure870

<b>Property</b>	<b>ASTM</b>	<b>Units</b>	<b>Metric</b>
Tensile Strength	D638-03	MPa	51
Elongation at Break	D638-05	%	18
Modulus of Elasticity	D638-04	MPa	2192
Flexural Strength	D790-03	MPa	80
Flexural Modulus	D790-04	MPa	2276
HDT, °C @ 0.45MPa	D648-06	°C	47
HDT, °C @ 1.82MPa	D648-07	°C	43
Izod Notched Impact	D256-06	J/m	24
Water Absorption	D570-98 24 hr	%	1
Tg	DMA, E''	°C	63
Shore Hardness (D)	Scale D	Scale D	83
Rockwell Hardness	Scale M	Scale M	81
Polymerization density	ASTM D792	g/cm <sup>3</sup>	1.17
Ash content	USP281	%	0.005

As support material (material used to print a model empty space) were used FullCure®705 Support a non-toxic gel-type photopolymer, that can be easily removed by Objet Waterjet System, Fig. 5, the equipment being included in the printer configuration. Waterjet use pressure water jet to remove material support.



**Figure 5.** Objet Waterjet System

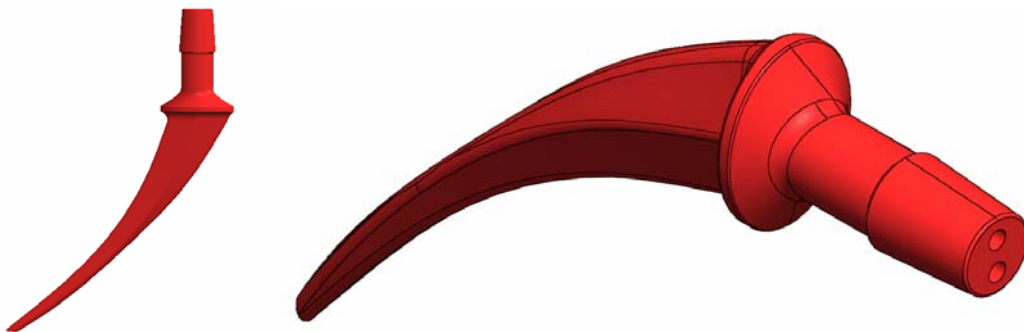
## THE CAD MODEL OF THE HIP IMPLANT

A total hip replacement (THR) is a surgical procedure whereby the diseased connective tissue (cartilage) and bone of the hip joint are surgically replaced with artificial materials. The hip joint is a ball and socket joint. The ball is the head of the thigh bone (femur). The socket (acetabulum) is a cup-shaped indentation in the pelvis. During hip replacement surgery, the head of the femur is removed and replaced with a metal ball set on a stem. The stem is inserted into the canal of the femur, as shown in Fig. 6 (right). It may be fixed in place with cement, or the stem may be designed for placement without bone cement. The socket is sanded down to healthy bone, and a plastic cup or socket is held in place with screws and/or bone cement, [9].



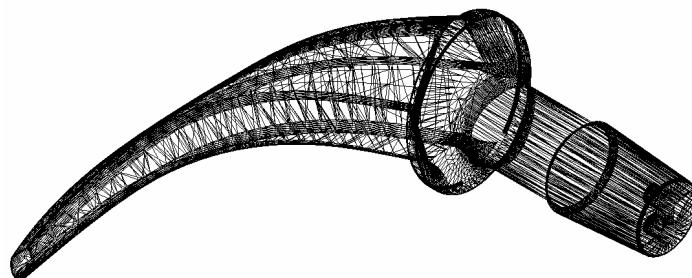
**Figure 6.** Hip prosthesis stem for cemented implantation

The 3D CAD model of the hip prosthesis stem was created using the SolidWorks software. The geometry of the hip implant is presented in Fig. 7. The maximal dimensions of hip implant are 150.13 mm x 103.18 mm x 26.65 mm.



**Figure 7.** The CAD model of the hip prosthesis stem

The CAD geometry of the hip implant was exported on an STL file, resulting in 19190 triangles, as shown in Fig. 8.

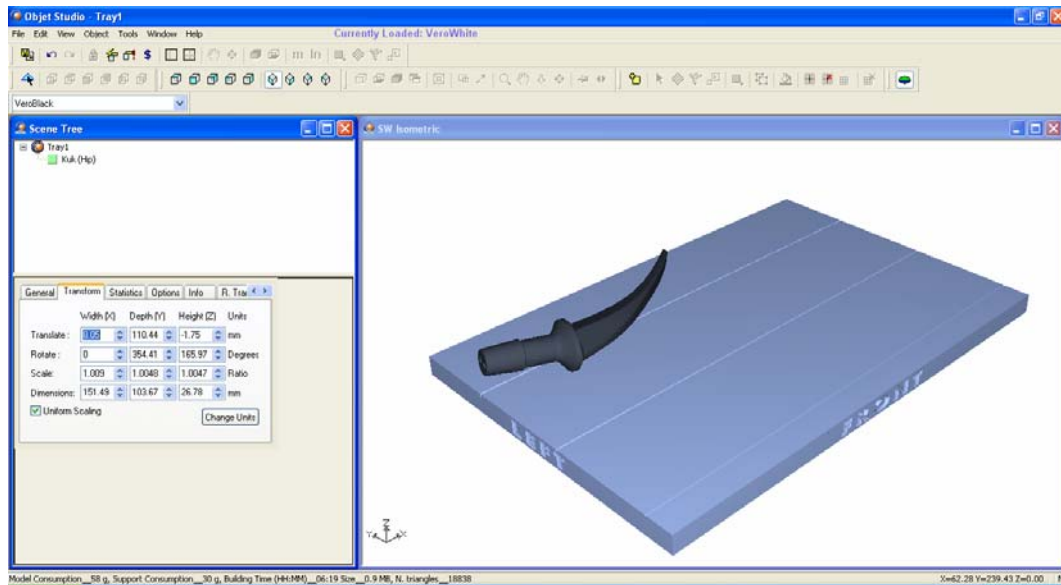


**Figure 8.** The STL format of the hip prosthesis stem (19190 triangles)

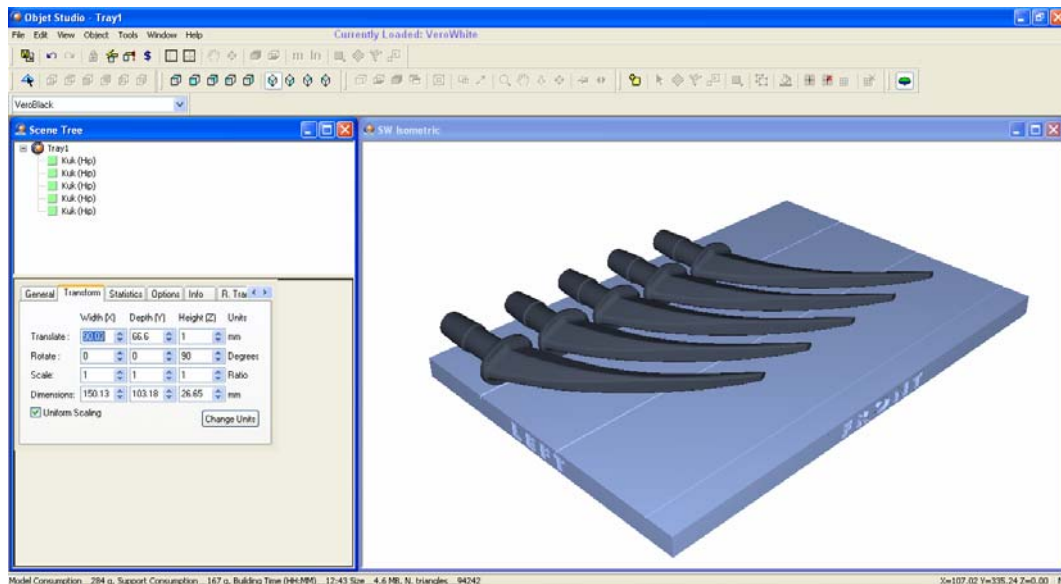
## THE PRINTING PROCESS

Models that are saved in a CAD program as STL files may be inserted into the Objet Studio tray. Fig. 9 and Fig. 10 shows the STL files loaded in Objet Studio software. The orientation of models on the build tray affects how quickly and efficiently they will be produced by the 3D printer, where and how much support material is used, and whether or not model parts will have a gloss finish. To minimize printing time, [6]:

- the longest dimension of a model must be placed along the X-axis;
- the smallest dimension of a model must be placed along the Z-axis;
- the tallest model must be placed on the left of the tray.



**Figure 9.** The STL file of the hip implant loaded in Objet Studio software and placed on printer tray



**Figure 10.** The 5 STL files of the hip implants loaded in Objet Studio software and placed on printer tray

When a tray is ready to be printed, it is sent to Job Manager, where it is placed in the print queue. When the job reaches the head of the queue, Job Manager preprocesses the tray file to create slices, and feeds them to the 3D printer. The printing parameters for the two case study are shown in Table 2.

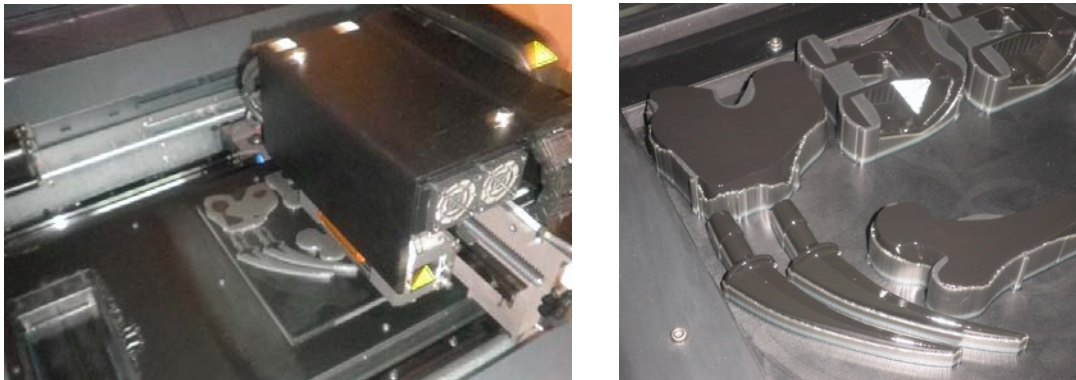
**Table 2.** Printing parameters for the hip implant

Parameter	UM	Hip implant 1 piece	Hip implant 5 pieces
Material	-	VeroBlack	VeroBlack
Model Material	g	58	284
Support Material	g	30	167
Printing Time	h/min	06 h 19 min	12 h 43 min
Layer Thickness (Z-axis)	µm	28	28
Layer's number	-	956	951
Triangles number	-	18838	94242

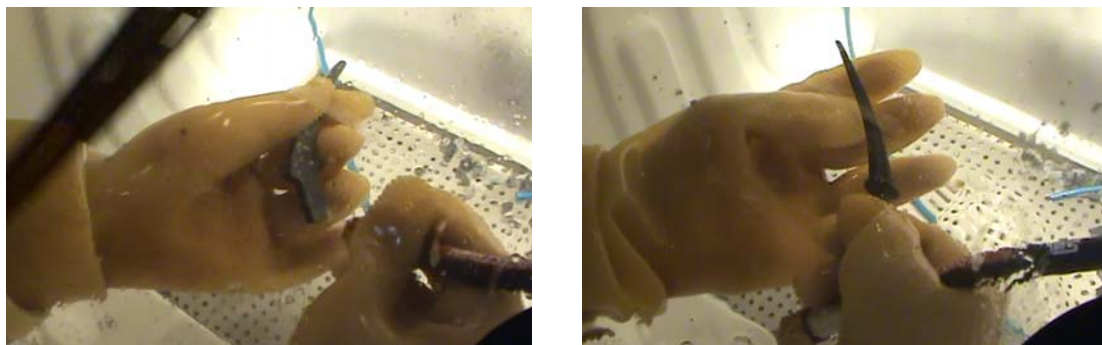
Objet Studio software offers the following additional features, [6]:

- dividing objects - to produce objects larger than the build tray by dividing the model into separate parts. With this feature, it is possible to print only a specific section of a model.
- choosing the support strength - when producing models, support material fills some hollow and empty sections. Objet Studio allows to adjust the strength of the structure formed with the support material. This adjustment is useful when producing either large / massive models or small / delicate models.
- smartcast - filling models with support material - many objects placed on the build tray from STL files are "solid". This means that, when printed, the model will be completely filled with model material. Often, especially with large objects, this is unnecessary. Instead, the model can be filled with support material, which is less costly. It is also advisable to fill models with support material when preparing them for investment casting, since this material burns off more quickly during the process of making the cast. Objet Studio enables to print objects on the build tray with an outer shell of model material and a center filled with support material. This feature of Objet Studio is called "Smartcast/Hollow".

For optimal efficiency, the two hip implants were decreased in the ratio 1:0.6 and manufactured along with a number of other parts. Fig. 11 shows the different stages in the printing of the hip implants. Fig. 12 shows the removal of the support material with Objet Waterjet System for the hip implant.



**Figure 11.** The different stages of the hip implants printing



**Figure 12.** The support material removal with Objet Waterjet System

Fig. 13 shows the final shape of the two hip implants, produced with Objet 3D Printer Desktop 30.



**Figure 13.** The final shape of the two hip implants

Additive Manufacturing technology is used to produce the pattern for investment casting. The accuracy of the produced patterns is compatible with the accuracy of those used in medical field especially for orthopedic surgery. The use of this semi-finished product is double. Firstly, it is possible to use this pattern as non wax pattern for investment casting. Secondly, by using the PolyJet patterns it is possible to make a silicon mould and with it cast the wax patterns in the vacuum chamber. Investment casting technology is applied hereafter. In [4], an ABS patterns was used to produce a silicon moulds for the casting of wax patterns.

In [5], room temperature vulcanizing (RTV) rubber mould was manufactured following the procedure of vacuum casting on a dedicated machine. Fig. 14 shows the silicon mould and a wax part obtained. Lost wax parts were obtained with a silicon mould using a hot camera.



**Figure 14.** Models of lost wax and silicon rubber mould [5]



## CONCLUSION

The application of Additive Manufacturing technology in the medical field, is an invaluable contribution of engineering technology to orthopedic surgery field. The PolyJet technology can be used to create complex objects, like hip implants and to use these objects for investment casting process as non wax pattern or for AM-fabricated molds for wax injection (indirect tooling). The following advantages are important: surface quality, smoothness details, great level of accuracy and reduced manufacturing time. Advances in Additive Manufacturing material will undoubtedly produce "clean" parts that can be used directly as implants.

The paper ends with a hope that in the future, Rapid Investment Casting solutions will emerge with the capability to provide dimensionally more accurate and better surface finish of medical implant castings of any size, shape and material with more speed and low costs.

## REFERENCES

- [1] Cheah, C.M., Chua, C.K., Lee, C.W., Feng, C., Totong, K., Rapid Prototyping and Tooling techniques: A review of applications for rapid investment casting, Springer-Verlag London Limited, 2004.
- [2] Chhabra, M., Singh, R., Rapid casting solutions: A review, Rapid Prototyping Journal, Vol. 17, No. 5, pp. 328 – 350, 2011.
- [3] Gibson, I., Advanced Manufacturing Technology for Medical Applications, Reverse Engineering, Software Conversion and Rapid Prototyping, John Wiley & Sons Ltd, 2005.
- [4] Horacek, M., Charvat, O., Pavelka, T., Sedlak, J., Madaj, M., Nejedly, J., Dvoracek, J., Medical implants by using RP and investment casting technologies, China Foundry, Vol.8, No.1, pp.107 – 111, ISSN 1672 – 6421, 2011.
- [5] Manuelde, A.M., Simoes, J.A., CAD-CAM-RTV – lost-wax casting technology for medical implants, Rapid Prototyping Journal, Vol. 15, No. 3, pp. 211 – 215, 2009.
- [6] Nedelcu, D., Raoul, A., Danu, F., Rajic, A.: Applications of the Rapid Prototyping Technology to manufacture the Pelton runners, Analele Universitatii "Eftimie Murgu" Resita Anul XX, Nr. 1, 2013, ISSN 1453 – 7397, Article in press.
- [7] Rajic, A., Manic, M., Rapid Prototyping technologies in investment casting of metal implants, Journal "IMK-14 - Research and Development", Krusevac, Year 16, Vol. 2, pp. 39 – 44, 2010.
- [8] Rajic, A., Stojadinović, S., Desnica, E., Nedelcu, D., Reverse Engineering application in creation of 3D CAD model for investment casting of knee implant, II International Conference – Industrial engineering and Environmental Protection (IIZS 2012), Zrenjanin, pp. 306 – 312, 2012.
- [9] Medical Disability Advisor, Hip Replacement Total, World Wide Web: <<http://www.mdguidelines.com/hip-replacement-total>> (cit. September, 24.2013).

## PROJECT OF MECHANICAL SYSTEMS DESIGN

**Thibault LE GALL**

Polytech Lille, Lille University Graduate Engineering School, Mechanical Design  
 Department, France

e-mail: [thibault.le-gall@polytech-lille.net](mailto:thibault.le-gall@polytech-lille.net)

**Abstract:** This work is a presentation of a project that students do in the Mechanical Design department at Polytech Lille (graduate school of engineering in France) during the 8th semester after the A-level. In order to complete the formation of the future engineer, the Mechanical Design Department has established an industrial project which is included in the schedule.

**Key words:** Mechanical design, industrial project, student

### INTRODUCTION

During the 8th semester (after the A-level), the students of the Mechanical Design Department at Polytech Lille work on an industrial project. They work in groups of 4-5 and there is one supervising teacher for 3 groups. This teacher oversee and guide the students. He does regularly a progress check of the project. 96 hours, it is about 20% of the ECTS credits of the semester, are reserved in the schedule for the realisation of the project: it is between 4 and 12 hours a week. To finish the project the students have to work during their free time, but the teachers are already open to answer questions and give advices. Each group works on a project which is given by a company or sometimes the university or the school. But each time there is a client who require a result, as the students were engineers.

		LUNDI			MARDI			MERCREDI			JEUDI			VENREDI			SAMEDI										
		08-10	10-12	14-16	08-10	10-12	14-16	16-18	08-10	10-12	14-16	16-18	08-10	10-12	14-16	16-18	08-10	10-12									
J	4	21 au 26	Met.El. A312	Conf. DAVI B50N	conférences en A319			Conf. VOITH T.			Conf. Ch. Detailleur			Présentat. en C5M2			Conf. Ch. J. Houliquet			Conf. Dumas Administration		Eco B311		Gestion B311		Comp B311	
F e v	5	28 au 2	Projet	Eco Chappe	Market Chappe	Manag B314	Manag B314	Anglais Gr1	TD Mot El A309	LV2 All	MCPM B313	Met.El. B313	Angl. Renf.	Gestion B313			MCPM B313	Eco Appert	Manag B314	Manag B314							
	6	4 au 9	Projet	Eco Chappe	Market Chappe	Market Appert	Comp Appert	Anglais Gr1	TD Mot El A309	LV2 All	TD Comp A309	Met.El. Appert	Eco B311	Angl. Renf.	Gestion B313			MCPM B313	MCPM TD D417	Manag B314	Manag B314					Projet	
	7	11 au 16	Projet	Eco B311		Manag B314	Market B314	Anglais Gr1	TD Mot El A309		J MECA		Projet	Angl. Renf.				MCPM B313	MCPM TD B308		Projet						
	8	18 au 23																									
m a r s	9	25 au 2	Projet	Met.El. Chappe	Comp Chappe	Projet	Anglais Gr1		LV2 All	TD Comp A309	Projet	Angl. Renf.	Gestion B313				MCPM B313	MCPM TD B308	TP Gr 1 2/ Simu Gestio Gr3 4		TP Gr 1 2/ Simu Gestio Gr3 4						
	10	4 au 9	Projet	Market Chappe	Comp Chappe	Projet	Anglais Gr1	TD Mot El A309	LV2 All	TD Comp A309	Projet	Angl. Renf.	Gestion B313				MCPM B313	MCPM TD B308	TP Gr 1 2/ Simu Gestio Gr3 4								
	11	11 au 16	Projet	Comp B314	Eco B311	Projet	Anglais Gr1	TD Mot El A309	LV2 All	TD Comp A309	Projet	Angl. Renf.	Gestion B313				Gestion B313	MCPM TD B308	TP Gr 1 2/ Simu Gestio Gr3 4								
	12	18 au 23	TP Gr 1 2/ Simu Gestio Gr3 4	TP Gr 1 2/ Simu Gestio Gr3 4	TP Gr 1 2/ Simu Gestio Gr3 4	TP Gr 1 2/ Simu Gestio Gr3 4	TP Gr 1 2/ Simu Gestio Gr3 4	TP Gr 1 2/ Simu Gestio Gr3 4	LV2 All	TD Comp A309	Projet	Angl. Renf.	CSM2 Gr2				MCPM B313	MCPM TD B308	TP Gr 1 2/ Simu Gestio Gr3 4								
	13	25 au 30	TP Gr 1 2/ Simu Gestio Gr3 4	TP Gr 1 2/ Simu Gestio Gr3 4	TP Gr 1 2/ Simu Gestio Gr3 4	TP Gr 1 2/ Simu Gestio Gr3 4	TP Gr 1 2/ Simu Gestio Gr3 4	TP Gr 1 2/ Simu Gestio Gr3 4	LV2 All	MCPM TD A309	Projet	Angl. Renf.	MCPM B313				Manag Appert	Manag Appert	Eco B311								
a v	14	1 au 6				Projet	Anglais Gr1		LV2 All		Projet	Angl. Renf.					Eco B313	MCPM Appert	TP Gr 3								
	15	8 au 13	Projet	TP Gr 1 2/ Simu Gestio Gr3 4	Projet	Anglais Gr1		LV2 All			Projet	Angl. Renf.															

Figure 1. Schedule of the 8<sup>th</sup> semester : between 4 and 12 hours project per week.

### MEANS AND SUBJECTS

To make this projects Polytech Lille gives a lot of tools: computer room with all the softwares that an engineer needs (CATIA, ANSYS, OFFICE...), a workshop to make prototypes, resources : an access to the ISO norms...etc.

A large part of the project is done on computers, so each group has a shared space on a server to save all the informations about the project. This space has to be tidy for the end of the semester and all the information about the project have to be in the file. To use this tool, the students have to respect a process to arrange the files : standard formats, standard names of the documents...etc. It is even more important to be in order if several people work in the same time on the same model.

### The clients:

The Mechanical Design Department at Polytech Lille is in contact with some companies for few years and they request studies each year. This studies are for the students of third to fifth year. For all the projects there is an engineer from the firm who gives informations and work lines: it is the client.

When the study is requested by the school, the client is a teacher. It could be to meet a need of the school (ex: a test bench for practical works) or to develop a system of the Mechanical Design Department (ex: Electric Vehicle).

For each project the students have to contact the client to identify his expectations. In some cases the client gives the specification, and in other cases the students have to write it, ask the right questions to the client to obtain specification informations.

### Some examples of the projects which did in 2013:

- Design a test bench for hybrid transmission, to simulate a transmission chain with different motorizations. It will be used to do practical works in the school. The client was moreover a professor of the Mechanical Design department.
- Improve an automatic gearbox for Renault. The objective was to replace the hydraulic torque converter by a gearbox with 2 gears.



- Design a test bench for metal rolling. The company FivesDMS want to recreate the rolling conditions of a "Sendzimir 20 cylinders" to improve it.
- Design a gearbox with 2 gears for a small electric vehicle which belongs to the School. This car is a support for many projects for students of the Mechanical Design, electronic and automatism department.
- Adapt an orbital wheel on a bicycle. MKNIX, a working group of Oxylane, want to create a new bicycle concept with a new design. This firm imagines, designs and sells sport and leisure equipments. The objective was to make solutions and lines of work to help the MKNIX engineers to develop the product.



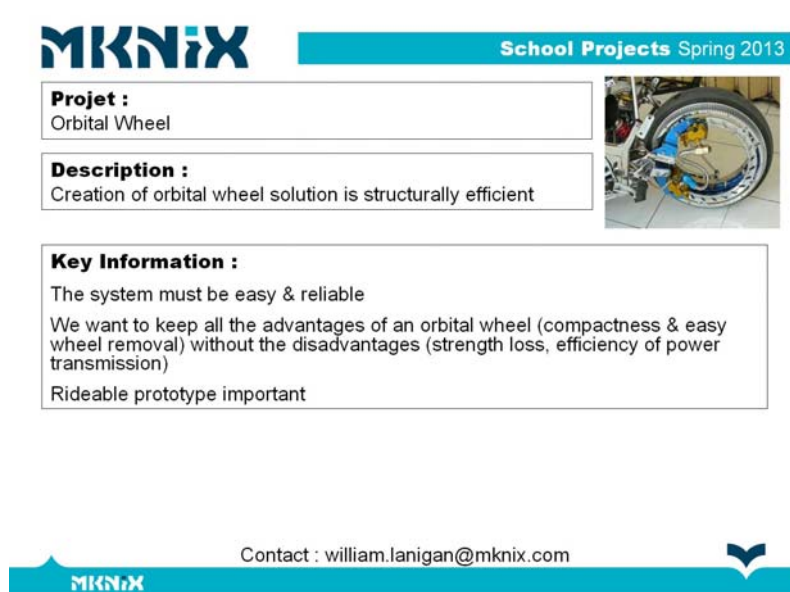
### THE ORBITAL WHEEL FOR MKNIX

The client want a pre-study to adapt an orbital wheel on a bicycle: new concept, new design...

Target: acquire concepts, solutions and lines of work to help the MKNIX engineers.

Work and study:

- guide and keep in position the wheel.
- transfer the cyclist power to the wheel.
- the frame shape of the bike.



The image shows a screenshot of a project page from MKNIX. At the top left is the MKNIX logo. To its right, a blue banner reads 'School Projects Spring 2013'. Below this, there are three main sections: 'Projet : Orbital Wheel', 'Description : Creation of orbital wheel solution is structurally efficient', and 'Key Information :'. The 'Key Information' section contains three lines of text: 'The system must be easy & reliable', 'We want to keep all the advantages of an orbital wheel (compactness & easy wheel removal) without the disadvantages (strength loss, efficiency of power transmission)', and 'Rideable prototype important'. To the right of the 'Description' section is a photograph of a mechanical assembly, likely the orbital wheel. At the bottom of the page, there is a contact email 'william.lanigan@mknix.com' and a small MKNIX logo on the left and a stylized blue logo on the right.

Figure 2. School projects in Spring 2013

### Tools used for the project

1. knowledges in mechanical design: static, kinematic, bearing calculations, gears...
2. softwares:
  - CATIA V5R21 for the design.
  - ANSYS 14 for the structural calculations.
  - RDM for the stress calculations.
  - Word, Excel, PowerPoint... for the reports and the presentations.

### CONCLUSION – RESULTS OF PROJECT

This kind of works has a lot of positive aspects. The benefits are for the students and for the clients:

- For the students it is discover an industrial project and maybe them future job: teamwork with a client and obligations, use the knowledges acquired during the formation in Polytech Lille, work on a concrete product which will be maybe make.
- For the clients it is have a free study, maybe not like an engineering office but something very close because the teachers deal with the groups through the projects. Moreover, the clients can present their company to people who will be engineers in few times.

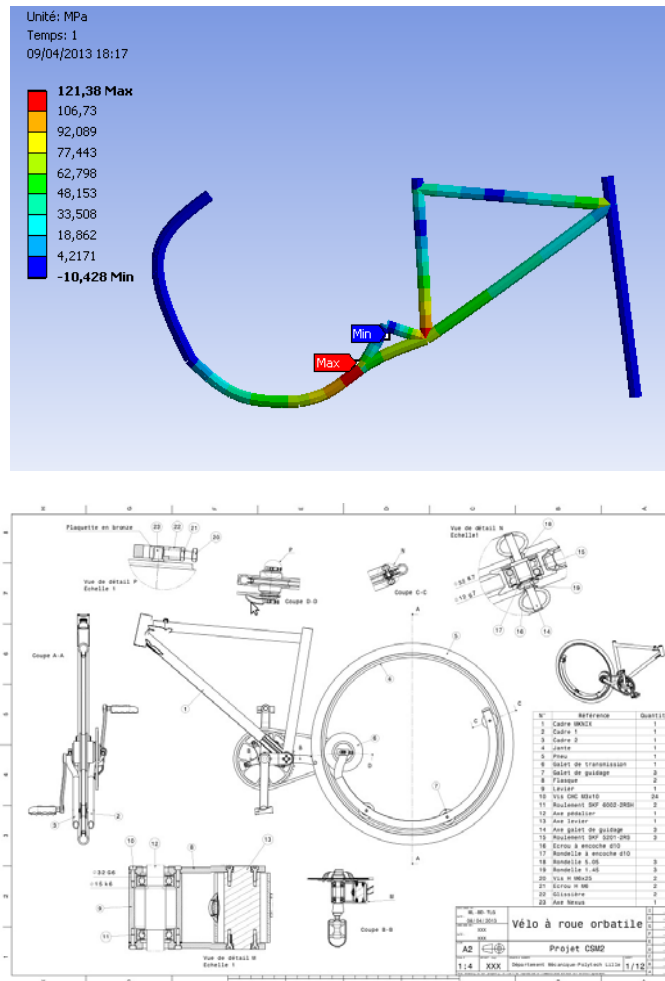


Figure 3. Fram structure calculation with ANSYS

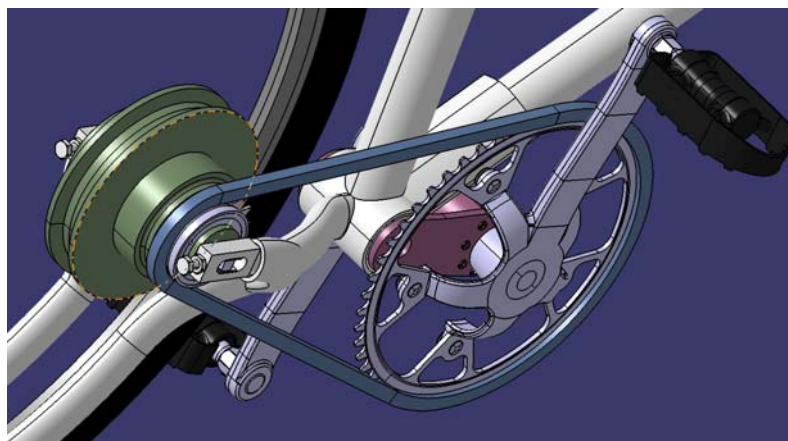


Figure 4. Transmission design with CATIA



**Figure 5.** CATIA model of the Orbital Wheel at the end of the project

## REFERENCES

- [1] Softwares: CATIA V5R21, ANSYS 14, RDM

## USE OF CAD APPLICATION IN THE EDUCATION OF COMPUTER ERGONOMICS

**Biljana Gemović, Nataša Subić, Tanja Krunić**

Higher Education Technical School of Professional Studies in Novi Sad

e-mail: [gemovic@vtsns.edu.rs](mailto:gemovic@vtsns.edu.rs)

**Abstract :** This paper presents the effect of education , which is classically done so far , and the proposal for the constant influence of modern CAD applications - computer animation. Based on a completed research it was determined that several hours working on computers can cause a range of health problems. As a sample of the study there were selected groups of young people professionally-oriented to working on computers, and as a basis we used data from the questionnaire for safe work on the computer that the participants in this study completed. For some of the negative consequences of long-term work on computers, which are linked to long-lasting improper body posture while working on computer, it is planned an impact of animation to constant education and health care.

**Key words:** computer ergonomics, education, computer animation.

### INTRODUCTION

In contemporary world, the use of computers is growing almost exponentially. Computers are used in business, education and for fun and communication. Computer use is especially popular in young people who every day spend more and more time searching the Internet, making movies and music, participating in social networks, discussion groups, etc. On the other hand, young people unfortunately play less sports and go rarely to recreation in nature, all of which mainly results in improper body posture, obesity, eyesight problems, unsociability, alienation and other. If a young person is also professionally oriented to working on computers, the risk of the aforementioned health problems is significantly increased.

Several hours working on computers every day causes a range of health problems, starting from minor ones to potentially fatal ones.

We are going to mention only some of the adverse consequences of working on computers: eyesight problems, dry eyes symptoms, glaucoma, addiction, anxiety, insomnia, headache, nausea, discolouration and cancer of skin (due to constant and multi-year holding of laptop in the lap), nutritional problems, obesity, diabetes, thrombosis, as well as injuries that according [1] can be classified into three groups:

- injuries due to repeated straining (paresthesia of the hand, injuries of tendons and muscle connections, tendinitis, tenosynovitis; a detailed description of the symptoms can be found in [9])
- disorders of upper extremities function (reduced movability and pains in upper extremities)
- problems with spine (pains in spine, back, neck, myofascial syndrome; a detailed description of the symptoms can be found in [9])

A more detailed description of the diseases that occur as consequences of working on computers can be found in [3-6]. According to these sources, persons who spend more of 30 hours per week working on computers have increased risk of the occurrence of some of the aforementioned health problems.

There is a wide range of measures that can be undertaken with the aim of reducing the risks of diseases occurrence connected with long hours of working on computers. Moreover, there is an array of ergonomic products on the market, products adapted for human body (keyboards, mouses, chairs) which application can significantly reduce the adverse effects of working on computers. We are going to single out only some of the mentioned measures that can help proper body positioning, and a more detailed list and the description of measures can be found in [1] and (7-12). One of the most wanted measures are: proper seating at the table, the monitor should be at a distance of 60-110 cm from the eyes, after an hour of working with the computer make a break of 10-15 minutes, provide quality monitors and monitor the protection of reflections and flashes of light.

The aim of this paper is to show the impact of education on the awarness of proper posture while working on computers. Education in the field of computer ergonomics can help us to avoid above

mentioned health problems. With classical education we influence on the awareness of the students as we have demonstrated and shown through the research. Due to the good results obtained with education we continue with our research that has spread in the form of constant influence education. In order to give even more effort in computer ergonomics education we are currently working on a computer animation, which we plan to set up as screen savers on the computers in our computer labs. The animations should remind our student on the correct posture.

## CONDUCTED RESEARCH

For the needs of this paper we conducted a research regarding computer ergonomics.

### The aim of the research/ Motivation

The aim of the conducted research was to analyse the effects of lecture on computer ergonomics presented to students of Higher Education Technical School of Professional Studies in Novi Sad in the school year 2010/2011 and 2011/2012. The obtained results should serve as a starting point for the preparation of material for lectures on the same topic that should be presented in the school year 2012/2013 to students of the first year of all studying groups in the subject *Computers*. We should single out the questions that the students gave inadequate answers to, therefore pay more attention to additional education of students on the topic during ergonomics lectures.

Having in mind that the test also contains questions about possible consequences to students' health, the authors of this paper got the idea to elaborate a concise manual by the application of computer animation about proper ergonomic position in working on computers. The animation will be going on automatically every single hour on computers in computer laboratories. At the end of school year 2012/2013 the students will be surveyed again.

### Research methods

The methods applied for the needs of this research are the following:

- Participants : students of Higher Education Technical School of Professional Studies in Novi Sad.
- Instruments: Testing in the field of computer ergonomics. The test was a written multiple choice or with questions where students are required knowledge of ergonomics computer or in another part of the test that the symptoms they feel or how they set up the computer at home.
- Procedure: Student did the test in terms of lectures in the computer. Testing was carried out individually and anonymously. The test for about 20 minutes as needed to each student do all the questions in the test.

### Techniques and tools of the research

The tools for the research is students' test in the field of BZR/computer ergonomics.

The aforementioned surveys/tests contain the following groups of questions :

- questions that test knowledge in the field of computer ergonomics.
- questions that are related to health problems of students that work on computers for many hours.

In the field of computer ergonomics, a survey list is given in the form of a questionnaire with questions in the form of essays for which answers are offered.

Survey/test in the field of computer ergonomics is given in the form of essay, i.e. no answers are offered in advance for a student to encircle.

### Conducted research

In October 2012 we conducted the testing of knowledge of students of Higher Education Technical School of Professional Studies in Novi Sad in the field of computer ergonomics.

The total of 305 students of 16 different studying programmes participated in the testing. The testing included all the three the years of studying.



With regard to the fact that the testing was conducted at the very beginning of the school year, students of I year were not able to attend the lecture of the mentioned field, therefore their participation in the testing was aimed at obtaining the insight into students' pre-knowledge in the field of computer ergonomics. The obtained results can afterwards be used for a target lecture.

After the first test completion, once a week students attended lecture on computer ergonomics as an obligatory subject *Computers*. During this education the knowledge was being directed to critical points of the first test, i.e. to issues students were bad at or to topics essential to preservation of their health. Then the survey was repeated with questions in the field of computer ergonomics and their attitude to proper working on computers. In the repeated survey there were questions regarding their health problems.

## **RESULTS OF THE CONDUCTED RESEARCHES**

The surveys that the students completed consisted of two parts: part I which represents the test of knowledge containing questions in the field of computer ergonomics and part II which represents a survey on possible presence of health problems connected to long hours of working on computers in students.

In the part to follow, we presented only some of the results of the conducted research.

The question that represents the starting point in the repeated survey is:

1. After the lecture on proper use of computer, did you decide to change something about computer use?

66% of the examinees answered they changed the way of working on computer, while 34% of them answered they preferred their old way of working on it.

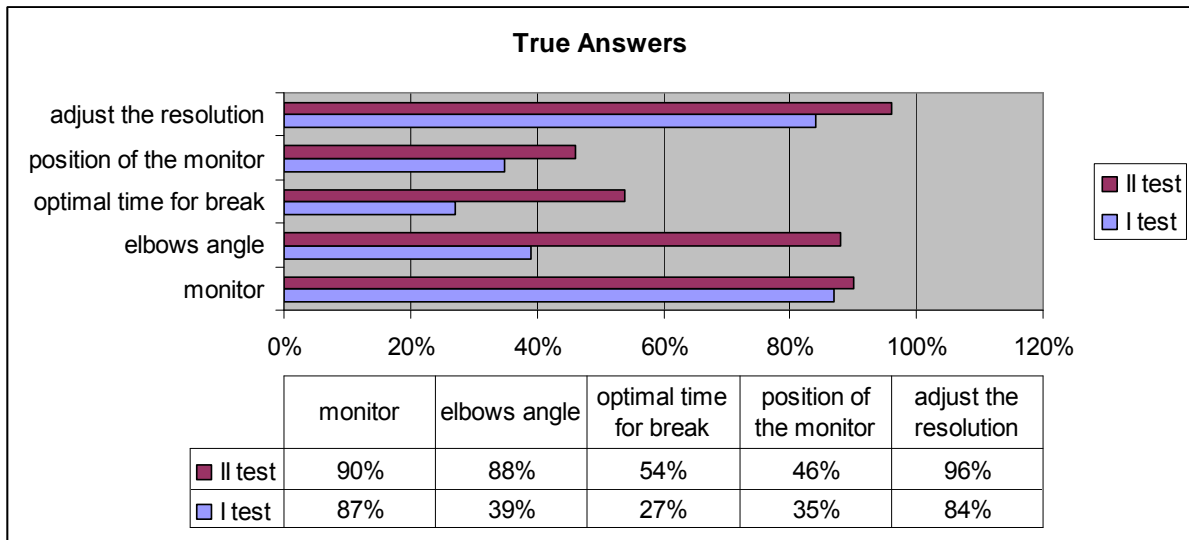
On the basis of greater share of changes in further work, i.e. bigger group that changed something in the way of working, we can continue to analyse the types of changes they made and the extent those changes influenced their health, as well as the influence of education.

During the lecture it was frequently emphasized that it was essential to make breaks when working on computers, to have proper body position, good lighting, adequate distance of eyes from the monitor and to buy ergonomic mouses and keyboards.

We are going to single out the questions regarding proper working on computers and make parallel analysis of the first and second test.

**Table1** – Questions that point at additional knowledge on computer ergonomics in the questioned students

<b>Questions</b>	<b>False</b>	<b>True</b>
1. The position of monitor in relation to its user? II test	10%	90%
1. The position of monitor in relation to its user? I test	13%	87%
2. Write the angle under which elbows should be bent while working on a computer? II test	12%	88%
2. Write the angle under which elbows should be bent when working on a computer? I test	61%	39%
3. Write optimal time after which a break should be made when working on a computer? II test	46%	54%
3. Write optimal time after which a break should be made when working on a computer? I test	73%	27%
4. How should we position the monitor in relation to light source? II test	54%	46%
4. How should we position the monitor in relation to light source? I test	65%	35%
5. Did you adjust the resolution of your monitor? II test	4%	96%
5. Did you adjust the resolution of your monitor? I test	16%	84%



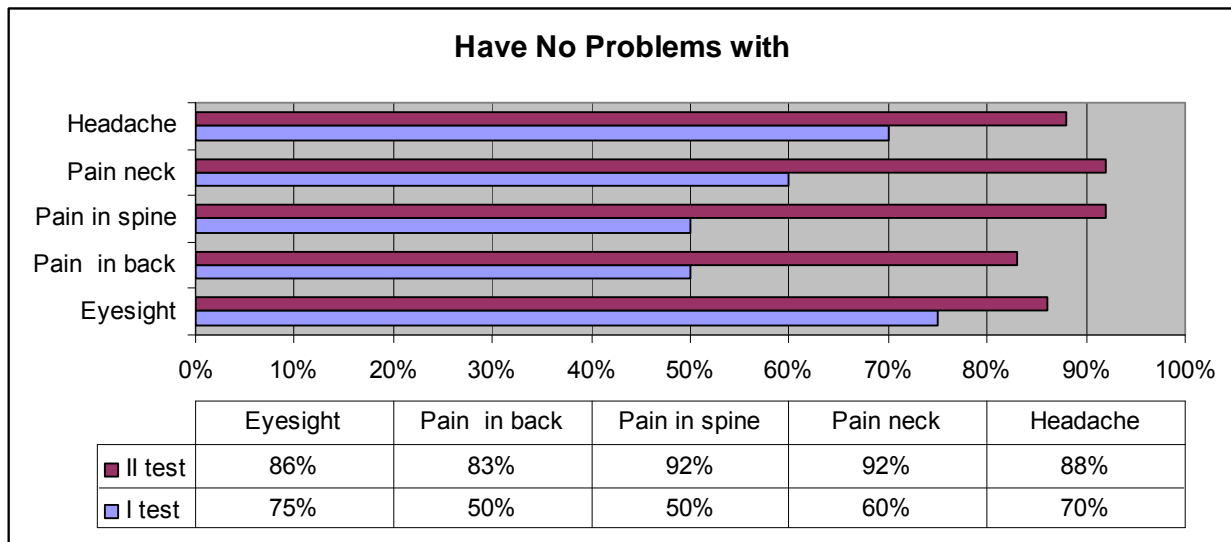
**Graph 1** –Graphic presentation of true answers given to control questions in testing knowledge

From the data presented in Table 1 and Graph 1 we can conclude that there is greater percentage of true answers in the second test. On the basis of questions connected to proper computer use, when comparing results of the first and second survey, we can conclude that education influenced proper computer use and computer ergonomics.

We can follow further the changes of students' health as a result of their education.

**Table 2** – Questions that point at the influence on health of examinees via computer ergonomics

Questions	No	Yes
1. Eyesight problems in I test	75%	25%
1. Eyesight problems in II test	83%	17%
2. Pain in back in I test	50%	50%
2. Pain in back in II test	83%	17%
3. Pain in spine in I test	50%	50%
3. Pain in spine in II test	92%	8%
4. Pain neck in I test	60%	40%
4. Pain in neck in II test	92%	8%
5. Headache in I test	70%	30%
5. Headache in II test	88%	12%



**Graph 2** - Graph presentation of the NO answers to control questions about the influence of computer ergonomics to examinees' health

We can conclude that surveyed students have fewer complaints about pains in eyes, spine, neck and headaches in the second test, i.e. after the education and application of adopted knowledge on computer ergonomics.

### THE APPLICATION OF COMPUTER ANIMATION

Aiming at education that includes previously stated topics in all the classrooms of Higher Education Technical School of Professional Studies in Novi Sad there was set a poster with recommendation on proper ergonomically projected working on computers.

The research established that beside technical recommendations to be fulfilled, the awareness of a computer user on proper working on computers plays a significant role. If the user becomes aware of the position of his body while working on a computer at every moment and is able to sit properly, he will have influence on the preservation of his health. This is the idea that is used for further influence on the awareness of the users, in our case students. Then we passed to periodical presentation of body positioning, i.e. to these three steps. In order to achieve periodicity, we applied computer animation that at certain intervals warns the user.

We are preparing computer animation that will activate itself when starting a programme and also periodically during lectures on monitors, warning and reminding of some basic recommendations of proper ergonomic work. That will serve as continual education of the students and staff. The results of the education will be compared with previously achieved results at the end of school year.

The aim of this action is to increase the level of awareness about ergonomically designed working place and behaviour when working on computers, especially with students of information technologies (IT) and designer (D) studying groups. In the second semester (that is to follow) out of total six obligatory subjects IT students attend five subjects with classes on computers, and IT students of the fourth semester attend all the five obligatory subjects with classes on computers. Design students in the second semester have three of six subjects in computer laboratory and in the fourth semester they have four of six subjects in computer laboratory.

### CONCLUSION

Risk of the occurrences of health disturbances due to improper body posture when working on computers is of essential importance with students of informatics and design, therefore education of it is necessary.

Suggested measures for the reduction of risk are the following:

- **Education within teaching process:** For three school years in a row, in the subject *Computers* the lectures on safe working on a computer are being held. The subject is attended by students of the first year of all the studying groups. It is recommended to continue with this education, as well as that the lecture on this topic be held on introductory lecture of subjects where the teaching is performed on computers.
- **Setting computer animation:** Safe working on a computer – ergonomic of a working place on all the computers in classrooms of Higher Education Technical School of Professional Studies in Novi Sad. It certainly must not be omitted the care of teaching as well as non-teaching staff (especially administrative services where the employees spend most of their eight working hours sitting by computers).
- **Spreading awareness about the importance of paying sports:** Starting from school year 2012/2013, the students of Higher Education Technical School of Professional Studies in Novi Sad of studying groups of civil and fire protection have the subject *Physical Education* within plan and programme for two times a week. It is being considered the introduction of the same subject for all the other students, therefore for the students of information technologies (IT) and designer (D) studying groups.

## REFERENCES

- [1] Lj. Ružić-Dimitrijević, Lj. Diković, (2011), Bezbedan rad na računaru, TEMPUS 158721 Kontrol biro Prister (2011), Primjena pravila zaštite na radu kod rada sa računalom, Zagreb
- [2] Božić, V., Kosić, S., Nikolić, B. (2006). Pravilnik o načinu i postupku procene rizika na radnom mestu i u radnoj okolini – komentar, VTS Novi Sad
- [3] Lj. Diković, Lj. Ružić-Dimitrijević (2009), Uticaj ergonomije računara u računarskog okruženja na zdravlje ljudi, Tempus projekat, 158781
- [4] B. Nikolić, Lj. Ružić-Dimitrijević (2009), Kako dalje – korekcija metode za procenu rizika radnog mesta i radne okoline u bezbednosti i zdravlju na radu i njena šira primena, Međunarodna naučna konferencija Bezbednosni inženjering, Kopaonik, Srbija, str 19-24.
- [5] Pravilnik o preventivnim merama za bezbedan i zdrav rad pri korišćenju opreme za rad sa ekranom, Sl. Glasnik RS br.106/09
- [6] Visual Ergonomics in the Workplace Anshel Jeffrey (1998), CRC Press Location: Boca Raton, FL, USA
- [7] Francesco Kilborn, Asa, (2009), Occupational Ergonomics, (2000) CRC Press Location: London, GBR,
- [8] Isabel L. Nunes, (2009), San Diego, CA, USA, Ergonomics - A Systems Approach, , InTech
- [9] Antić, (2013) Bolovi usled rada na računaru – zašto nastaju i kako ih lečiti [http://www.bol.rs/blogovi\\_strucnjaka/bolovi-usled-rada-na-racunaru-%e2%80%93-zasto-nastaju-i-kako-ih-leciti\\_30\\_06\\_2011#content](http://www.bol.rs/blogovi_strucnjaka/bolovi-usled-rada-na-racunaru-%e2%80%93-zasto-nastaju-i-kako-ih-leciti_30_06_2011#content)
- [10] Top 5 Health Problems Relating to Computers (2012), Problems <http://voices.yahoo.com/top-5-health-problems-relating-computers-1962735.html>
- [11] Health Problems Caused By Use of Computers (2012), <http://www.healthoma.com/health-problems-caused-by-use-of-computers/>
- [12] Health Problems caused by Computers (2012), <http://www.articlesbase.com/health-articles/health-problems-caused-by-computer-828096.html>
- [13] Computer Related Health problems (2012), <http://www.mytechsupport.ca/forums/index.php?to=pic=942.0;wap2>
- [14] Ergonomski uslovi za rad na računaru (2012), <http://www.ordinacije-laboratorije.com/fizikalna-medicina-rehabilitacija/sedenje-za-racunarom>
- [15] Kako pravilno sjediti za kompjuterom (2012), <http://www.zenasamja.me/zdravlje/843/kako-pravilno-sjediti-za-kompjuterom>

## E-LEARNING STANDARDS AN OVERVIEW

**Eleonora Brtka, Višnja Ognjenović**

University of Novi Sad, Technical Faculty "Mihajlo Pupin", Zrenjanin

e-mail: [norab@tfzr.uns.ac.rs](mailto:norab@tfzr.uns.ac.rs), [visnjao@tfzr.uns.ac.rs](mailto:visnjao@tfzr.uns.ac.rs)

**Abstract:** In recent years, the learning technology standardization process is one of the key research activities in computer-based education. The US Department of Defense, the European Commission and IEEE have set up committees to deliver recommendations and proposals in this area. The objective is to allow the reuse of learning resources and to offer interoperability among heterogeneous e-learning systems. This paper provides an overview of standards and specifications bodies and processes relevant to e-learning and particularly to learning objects and related infrastructures.

**Key words:** e-learning, standards, Interoperability, learning object

### INTRODUCTION

Standards bring order to the world and e-learning standards are bringing great new benefits to this domain. Where would we be without standards like the metric system, international distress signals, and TCP/IP? World travelers know how to deal with the absence of uniform electrical standards. The lack of interoperability is quite evident when the electric shaver plug won't fit the electrical socket [15]. By adhering to standards, courseware builders can construct components completely independent of the management systems under which they are intended to run—that's interoperability. The life expectancy of a courseware component is greatly increased when we know that we can upgrade a management system and it still works, or when we reuse that component in a totally new course. The proprietary learning technologies of the past, while providing good service in their time, do not provide the benefits available by adopting standards. E-learning standards promise—and deliver—interoperability as well as reusability, durability, and accessibility. The observation "the nice thing about standards is that there are so many to choose from" [14] has been circulating in e-learning standards circles for some time. This statement certainly reflects the varied and complex nature of standards organizations and standards development processes [5].

### STANDARDS AND STANDARDIZATION

Standards can be defined as "documented agreements containing technical specifications or other precise criteria to be used consistently as rules, guidelines, or definitions of characteristics, to ensure that materials, products, processes and services are fit for their purpose" [2]. In the context of e-learning technology, standards are generally developed to be used in systems design and implementation for the purposes of ensuring interoperability, portability and reusability. These attributes should apply to both the systems themselves and of the content and metadata they manage. Standards and standardization processes are important to adopters and ultimately to end users, but not always for the reasons given by advocates and promoters. Typical of supporting arguments are claims that e-learning standards "will produce better learning, education, and training – which (will have) a positive effect upon all societies" [10]. This positive potential or hopeful outcome of standardization is certainly reason enough for technology users and standards adopters to be aware of general developments in e-learning standardization. However, it is the ambivalent, complex and uncertain effects of technical standards on processes and products that are much less often remarked upon, and that can be of equal if not greater importance to adopters and ultimately, end users [13].

An important part of the standardization process is the development of "specifications." Specifications can be said to represent standards early in their development, prior to receiving approval from standards bodies, and they tend to be experimental, incomplete and more rapidly evolving [4]. They capture a rough consensus, and are meant to enable technology development and the management of short-term risk. Standards, on the other hand, are much more conclusive, complete, and evolve much

more slowly. They should capture general acceptance, can serve regulatory purposes, and be used to manage long-term risk [4].

### **THE DEVELOPMENT OF TECHNICAL STANDARDS AND SPECIFICATION**

Advances in information and communication technologies, and specifically in Multimedia, Networking and Software Engineering promoted a new generation of computer-based training systems. Internet is today the ubiquitous supporting environment for virtual and distributed learning environments. As a consequence, many institutions, both public and private, take advantage of new technologies to offer training products and services at all levels [1]. Nomenclature is given in Table 1.

**Table 1.** Nomenclature

ACTS	Advanced Communication Technology and Services
ADL	Advanced Distributed Learning. Initiative from the US DoD
AICC	Aviation Industry CBT Committee
ANSI	American National Standardization Institute
ARIADNE	Alliance of Remote Instructional Authoring and Distribution Networks for Europe
ATM	Asynchronous Transfer Mode
CBT	Computer-Based Training
CEN	Comite Europeen de Normalization, European Committee for Standardization
DC	Dublin Core
DCAC	Dublin Core Advisory Committee
DC-ED	Dublin Core metadata for Education
DCMI	Dublin Core Metadata Initiative
DCMES	Dublin Core Metadata Element Set
EdNA	Education Network Australia
ERIC	Educational Resources Information Center
GAIA	Generic Architecture for Information Availability
GEM	Gateway to Educational Materials
GEMSTONES	Extensions to Metadata Standards for ON-Line Education Systems
GESTALT	Getting Educational Systems Talking Across Leading edge Technologies
IEC	International Electrotechnical Commission
IEEE	The Institute of Electrical and Electronics Engineers
IETF	The Internet Engineering Task Force
IMS-SEL IMS	Standard Extension Library
ISSS	Information Society Standardization System Subcommittee, hosted by CEN
ISO	International Standardization Organization
KPS ARIADNE's	Knowledge Pool System
LDAP	Lightweight Directory Access Protocol
LOM	Learning Object Metadata
LTSC	Learning Technologies Standardization Committee, hosted by the IEEE
PAPI	Public And Private Information
PROMETEUS	PROMoting Multimedia access to Education and Training in EUropean Society
QoS	Quality of Service
RDS	Resource Discovery Service
SCORM	Sharable Content Object Reference Model
TFADLT	Total Force Advanced Distributed Learning Action Team
XML	Extended Markup Language

In this situation, educational systems and resources proliferate, and a need for standardization becomes apparent. Like in other standard-driven initiatives, standardization applied to learning technologies will enable reuse and interoperation among heterogeneous software systems. To achieve this, a consensus is needed on architectures, services, protocols, data models and open interfaces.

In e-learning, both standards and specifications are often multi-part, typically consisting of:

- 1) a "data model" which specifies the standard's "normative" content in abstraction,
- 2) one or more "bindings," which specify how the data model is expressed in a formal idiom, which is most often XML, and
- 3) an "API" (Application Programming Interface) or "service definition" that is somewhat less often provided to define points of contact between cooperating systems [8].

The development of technical standards and specifications in e-learning can be seen as part of the maturation of this recently emergent field or industry.

### **IMS, IEEE LTSC AND ISO/IEC**

This paper provides an overview of standards and specifications bodies and processes relevant to e-learning and particularly to learning objects and related infrastructures. It focuses specifically on three key organizations and on the e-learning specifications and the standards they develop: the IMS Global Consortium, the IEEE LTSC (Institute of Electrical and Electronics Engineers, Inc. Learning Technology Standards Committee), and the ISO/IEC (International Standards Organization/International Electrotechnical Commission). There are, of course, other standards organizations (many of them national standards bodies) that may make significant contributions to international e-learning standards development, but which fall outside of the scope of this article. These include ANSI (American National Standards Institute), NISO (National Information Standards Organization), DIN (Deutsches Institut für Normung), BSI (British Standards Institute), and the CSA (Canadian Standards Association).

### **IMS**

The IMS Global Learning Consortium, Inc. (IMS) "develop[s] and promote[s] open specifications for facilitating online distributed learning activities" [9]. The IMS is a consortium formed by almost 200 commercial, governmental and other entities. Currently, the IMS has some 80 contributing members, a significant number of which are American and British commercial entities, but which also include universities and federal governmental agencies.

The IMS Global learning Consortium asks the question, How do we describe learning content, discover and reuse that content, and assure that content is fully interoperable when moving from one administrative system to another? XML, itself a specification of the World Wide Web Consortium (W3C), is the *lingua franca* of all IMS specifications. That implies a level of built-in interoperability and durability. However, the IMS specifications go much further. For example, the IMS Meta-data Specification defines a method for describing learning content: a description of the content, the title, the author, location (URL), cost and payment structure, prerequisites, learning taxonomy, and much more. Once I "tag" a chunk of learning content with meta-data, someone else can discover that object and use its description to see if it might fit into their course. Before the meta-data tagging scheme and these formal specifications, consumers of learning content had a difficult time determining what was out there to reuse.

### **IEEE LTSC**

The IEEE "is a non-profit, technical professional association of more than 380,000 individual members in 150 countries" [7]. It is also an accredited standards development organization. Within the IEEE, the LTSC (Learning Technology Standards Committee) focuses on standards development

specifically in the area of e-learning technologies producing "accredited technical standards, recommended practices and guides" [12]. The LTSC also "coordinates formally and informally with other organizations that produce specifications and standards for similar purposes" [12]. These other organizations include the IMS and the e-learning standards development body in the ISO/IEC.

Leaders within the U.S. Department of Defense saw a need to fuse a number of more narrow specifications; like those of the AICC, IMS, W3C, and Institute of Electrical and Electronics Engineers (IEEE) Learning Technology Standards Committee into an all encompassing standard for next generation online learning. That work began in with the formation of the Advanced Distributed Learning (ADL) initiative in 1997. ADL built upon the work of other initiatives and defined new specifications to glue everything together. The result is the Sharable Content Object Reference Model (SCORM) [3]. SCORM is a model for defining, packaging, and managing learning objects. The sharable content object (SCO), the ADL name for a learning object, is the building block of a topic, a lesson, or a course. SCORM defines an API for a learning management system (LMS) to manage and communicate with SCOs and for SCOs to communicate with the LMS. SCORM is a model for designing an interoperable, durable learning system. It does not specify a programming language, authoring tool, or operating system; however, you will find most implementers using XML, Java, JavaScript, and HTML. Furthermore, SCORM does not (currently) address instructional design issues, nor does it prescribe specific functionality for LMSs.

### **ISO/IEC**

The ISO is an internationally and UN-recognized body for standardization founded in 1946. It is responsible for creating standards in many areas, including computers and communications. Its members comprise the national standards organizations of approximately 140 countries. The IEC is a similar international organization that "prepares and publishes international standards for all electrical, electronic and related technologies." [6] To avoid duplication of efforts, the ISO and IEC formed a Joint Technical Committee (JTC1) to "develop, maintain, promote and facilitate IT standards" in a number of areas of common interest [11].

### **THE DEVELOPMENT OF THE IEEE LEARNING OBJECT METADATA (LOM) STANDARD**

The IEEE LOM, a standard that is central to learning objects and repositories, was originally developed in response to the very practical needs of those assembling online collections of reusable learning materials that required standardized metadata for the purposes of discovery, management and resource sharing within and between collections. In 1996, the IMS (then known as the "Instructional Management Systems" consortium), and ARIADNE (Alliance of Remote Instructional Authoring and Distribution Networks for Europe) began the joint development of the Learning Object Metadata, (at approximately the same time as the emergence of the Dublin Core Metadata Initiative). The development of the LOM was subsequently handed over to the IEEE LTSC, where, after multiple drafts and revisions, it was developed into an official IEEE standard.

### **THE IMS LEARNING DESIGN SPECIFICATION (IMS LD)**

IMS LD is a specification that has a much shorter history than the LOM. However, the IMS LD has been the subject of great interest in a variety of e-learning research communities. This specification has its beginnings in the Open University of the Netherlands, in the form of an "Educational Modeling Language" developed by Rob Koper. This modeling language was brought more or less mid-stream into an IMS working group that was originally charged with the task of developing a specification related to instructional design. This working group subsequently undertook the task of simplifying this modeling language or system, and adapting it to existing IMS specifications, including the IMS version of "Learning Object Metadata".



## CONCLUSION

Educational technologies standardization is a challenging process. There are many issues that have to be addressed. Many different institutions and organizations are contributing to this. From a strictly methodological point of view, this field is a melting pot where traditional approaches to standardization, driven by rigid, slow-reacting, classical standardization bodies producing recommendations from scratch, merge with new approaches driven by users or industry, which produce standards from already available expertise and products. This situation also underscores the value of research that would help demystify the complex processes of e-learning standards development, and (perhaps more importantly) consider the possible and actual effects of these standards on common educational organization and practice.

## Acknowledgment

Ministry of Science and Technological Development, Republic of Serbia financially supports this research, under the project number TR32044 "The development of software tools for business process analysis and improvement".

## REFERENCES

- [1] Anido, L. E. et al., Educational metadata and brokerage for learning resources, *Computers & Education* 38 (2002)
- [2] Bryden, A. (2003) *Open and Global Standards for Achieving an Inclusive Information Society*
- [3] Eleonora Brtko, Zlatica Korkaric, Vladimir Brtko: The selection of the essential elements of SCORM standard, *Applied Internet and Information Technologies - ICAIIT 2012*, October 26, 2012, Zrenjanin, Serbia, pg. 363-367, ISBN 978-86-7672-173-3
- [4] Farance, F. (1999). Learning Technology Standards Committee Work Program and Process
- [5] Friesen, N. (2005) Interoperability and Learning Objects: An Overview of E-Learning Standardization, *Interdisciplinary Journal of Knowledge and Learning Objects*
- [6] IEC (2002). IEC Website.
- [7] IEEE (2002)
- [8] IEEE (2004). WG11: Computing Managed Instruction.
- [9] IMS (2003). IMS Website.
- [10] ISO (2002). Information Technology: Learning by IT. *ISO Bulletin*. June 2002.
- [11] JTC1 (2002). JTC1 Website.
- [12] LTSC. (2002). LTSC Website.
- [13] Slaton, A. & Abbate, J. (2001) The Hidden Lives of Standards: Technical Prescriptions and the Transformation of Work in America. In M. T. Allen & G. Hecht (Eds.), *Technologies of Power* (pp 95-144). Cambridge, MA: MIT Press.
- [14] Tannenbaum, A. (1981). *Computer Networks* (2nd ed.) New York: Prentice-Hall.
- [15] [www.webbasedtraining.com](http://www.webbasedtraining.com)

## SEARCH ALGORITHMS IN TRAVEL ROUTE PLANNING

Višnja Ognjenović, Eleonora Brtka

University of Novi Sad, Technical Faculty "Mihajlo Pupin", Zrenjanin

e-mail: visnjao@tfzr.uns.ac.rs, norab@tfzr.uns.ac.rs

**Abstract:** In this paper, a review of Search Algorithms in Travel Route Planning will be given. A search problem will be described. The problem of the shortest route is defined by graph. Moreover, performances of the most frequently used search algorithms are shown, as well as the route planner options. A parameter analysis for finding the optimal route in comparison to economic fuel management was conveyed, which represents one of the most important factors of environmental protection. The paper is a theoretical basis for solving the problem of travel route planning.

**Key words:** search algorithm, travel route planning, fuel savings

### INTRODUCTION

Search is a central topic in Artificial Intelligence. Search algorithms are used for a multitude of tasks of artificial intelligence. One of them is path finding. There is a myriad of search algorithms, globally categorized to uninformed and informed search techniques. The best known uninformed techniques are depth-first search, breadth-first search, iterative deepening, brute force, back tracking and other. Known as "heuristic search," informed search strategies use information about the domain. Heuristic search methods promise to find the shortest path for path planning problems that are faster than uninformed search methods. Among them there are hill climbing, best-first, greedy search, beam search, A, A\*.

Dijkstra algorithm, namely algorithm A\* as its generalization, is basic and most frequently used to calculate the shortest route in graph. Algorithm A\* reduces the number of graph nodes which need to be examined. This reduction is based on using the heuristics which estimates the minimal distance to the target node. Calculating the optimal route in transport between the starting and ending nodes is one of the examples of algorithm application on everyday use. It is frequently used while planning car routes or public transportation routes. [1]

A search problem is defined in terms of states, operators and goals, where a state is a complete description of the world for the purposes of problem-solving. The initial state is the state the world is in when problem solving begins. A goal state is a state in which the problem is solved. An operator is an action that transforms one state of the world into another state [2]. Given the defined state space, state space search is the set of all possible sequences of legal moves from a tree (the nodes of the tree are labeled with states; for each of the legal follow-up moves of a given state, any node labeled with that state will have a child labeled with the follow-up state) [3].

According to [4] many travel planners using heuristic and uninformed algorithms are giving better results than the ordinary travel planners. Graph search algorithms are used in the travel planning which make any travel planner user friendly and time saving.

### THE SHORTEST-PATH PROBLEM

The convenience of a road network is the easy representation in form of graph, i.e., collection of nodes  $V$  (for junctions) and edges  $E$  (for road segments), with each edge connecting two nodes. A weight, i.e. values like road length or an estimation of the travel time is assigned to each edge [5]. The problem of calculating the shortest path between two nodes is a classical problem, which actually comes in several types:

- point-to-point: calculating the shortest path length from the source node  $s \in V$  to the target node  $t \in V$ ;
- single-source: calculating the shortest path lengths to all nodes  $v \in V$  for the source node  $s \in V$ ;
- many-to-many: calculating the shortest-path length for each node pair  $(s, t) \in S \times T$  for given node sets  $S, T \subseteq V$ ;
- all-pairs: this is a special case of the previous variant with  $S := T := V$ .

In 1959, Dijkstra [6] solved the problem in the majority of cases by giving an algorithm which solves the single-source shortest-path problem, using  $O(m+n)$  priority queue operations for a graph  $G=(V,E)$ , where  $n$  is the number of nodes and  $m$  – number of edges [5].

### DIJKSTRA'S ALGORITHM

Dijkstra's algorithm [6] can be used to compute the shortest paths from a single source node  $s$  to all other nodes in a given graph. According to [7], if the source node  $s$  is assigned the role as root, Dijkstra's algorithm finds the shortest paths from  $s$  to all other nodes through growing the shortest-path tree. During this process, nodes of the graph can be unreached, reached, or settled. A node already belonging to the tree is settled. The shortest path  $P^*$  from  $s$  to  $u$  can be found and the distance  $d(s,u)=w(P^*)$  is known if a node  $u$  is settled. A node that is adjacent to a settled node is reached, as well as a settled node. In this case, a path  $P$  from  $s$  to  $u$  (not necessarily the shortest one) has been found and a tentative distance  $\delta(u) = w(P)$  is known. The nodes which are not reached are called unreached and in this case  $\delta(u) = \infty$ . The reached, but unsettled nodes are called queued and are managed in a priority queue. Here, the notion of the tentative distance  $\delta(u)$  presents the priority of a node  $u$  in the priority queue.

### MEASURING SOLVING PERFORMANCE

A problem solving algorithm can have either failure or solution as the output. Some algorithms can, however, have an infinite loop and never give an output. Algorithms can be evaluated on several parameters. Table 1 (retrieved from [4]) gives the comparison of search algorithms by the parameters:

- Completeness – if the solution is possible, is the algorithm guaranteed to find it?
- Optimality – is the optimal solution possible through the provided strategy?
- Time Complexity – what time is required to find a solution?
- Space Complexity - how much memory is needed to perform the search?

**Table 1.** Comparison of different search algorithms

Algorithm	Time	Memory	Complete	Optimal
Breadth First	$O(b^d)$	$O(b^d)$	Yes	Yes
Depth First	$O(b^d)$	$O(d)$	No	No
Iterative DF deepening	$O(bd)$	$O(d)$	Yes	Yes
Bidirectional	$O(b^{d/2})$	$O(b^{d/2})$	Yes	Yes
Hill climbing	$O(b^d)$	$O(1)-O(b^d)$	No	No
Best First	$O(b^d)$	$O(b^d)$	Yes	No
A*	$O(b^d)$	$O(b^d)$	Yes	Yes
ID A*	$O(b^d)$	$O(d)$	Yes	Yes
Beam Search	$O(n^d)$	$O(n^d)$	No	No
Means End	$O(b^d)$	$O(b^d)$	No	No
Generate & Test	$O(((bd!)/((bd-d)!))/2)$	$O(d)$	Yes	No
Asynchronous Dynamic	$O(b^d)$	$O(1)$	Yes	Yes
Learning Real Time A*	$O(b^d)$	$O(b^d)$	Yes	Yes
Real Time A*	$O(b^d)$	$O(b^d)$	Yes	No

Where:

d =depth of solution with in search tree;  
b = branching factor of search tree;  
n =subset of b for which algorithm will actually process.

Finding the shortest path with finding the solution for additional conditions is the problem which complexity depends on the number and complexity of these additional conditions. Roads can be categorized according to more conditions, like type of road, its quality (main road/highway), traffic congestion, tourist attractions, and speed limit.

## ROUTE PLANNER OPTIONS

Some of the options (parameters) of route planner are:

- The shortest distance – for many route planners, this is actually the only parameter;
- Choice of path points – provided by the ‘via’ option, or directly, choosing a point on map;
- The shortest time – related to choosing the shortest road or highway;
- The type of road – any road, highway yes/no, and other options;
- Sightseeing – for those who want to see the tourist attractions along the way;
- Economical - the most fuel-efficient route that also avoids toll roads;
- Minimise delays – chooses the more secure ways because of traffic congestions;
- Weather conditions while traveling;
- Type of car;
- Type of fuel;
- Fuel consumption.

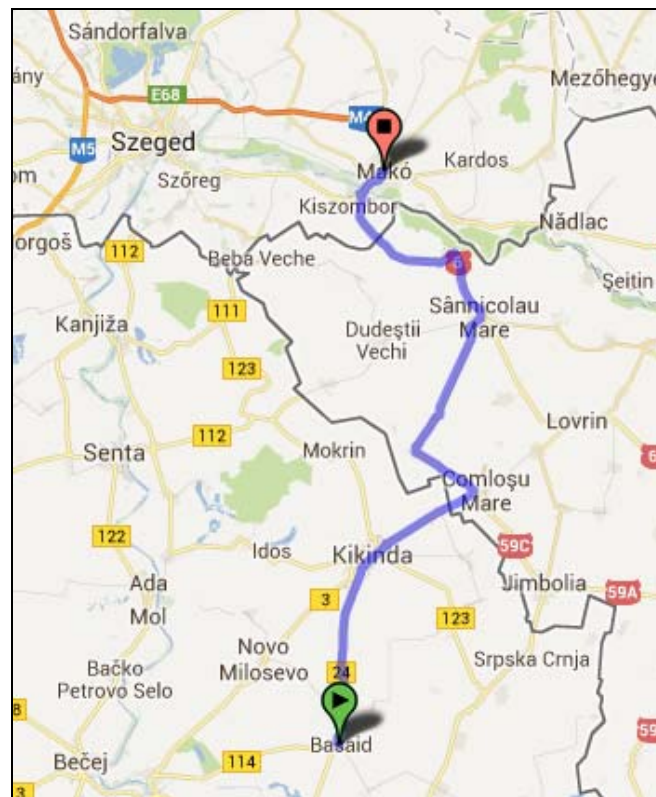
Figure 1 shows the ViaMichelin Maps and Routes [8], with a wide range of options. In fact, this application was one of the most frequently used planner for individuals.



**Figure 1.** ViaMichelin - Options

However, there is a problem of transition from one country to the other. The following example presents a very characteristic situation.

**Example.** Figure 2 shows the result of online planner AA Route planner [7], which the distance between Bašaid [Serbia] and Makó (Hungary) was programmed on. However, the fact that Kikinda border crossing is not international and that, once a person enters Romania, they cannot go to Hungary. The result obtained was: Distance: 91.6 km, Time: 1 hr 36 min.



**Figure 2.** The shortest distance between Bašaid and Makó

Like many others, this planner has an option of additional point choosing, based on which the shortest path is calculated. If Szeged (Hungary) is chosen, the result gives the path which is about 50% longer: Distance: 148.5 km, Time: 2 hr 35 min.

## FUEL CONSUMPTION OPTION (PARAMETER)

### Official U.S. Government Source for Fuel Economy Information

Fuel consumption is a factor considered more seriously only just in the previous several years. U.S. Department of Energy – Energy Efficiency and Renewable Energy section and U.S. Environmental Protection Agency – section Office Transportation and Air Quality provides the web site, the Official U.S. Government Source for Fuel Economy Information (Figure 3). It helps road planning, so as to obtain maximum fuel economy [9]. Search Algorithm finds the shortest path and based on it calculates the fuel consumption for the chosen type of vehicle. In this way, a comparison can be made in order to calculate the fuel consumption for a chosen path, on the basis of data on the vehicle.

Figure 3 shows the shortest distance between Washington and Sacramento and for a selected vehicle types give fuel consumption and price. Selected cars are:

- Ford Focus FWD (2011), Auto 4-spd, 4 cyl, 2.0 L
- Cadillac Escalade Ext AWD (2006), Auto 4-spd, 8 cyl, 6.0 L
- Buick Enclave AWD (2009), Auto 6-spd, 6cyl, 3.6 L

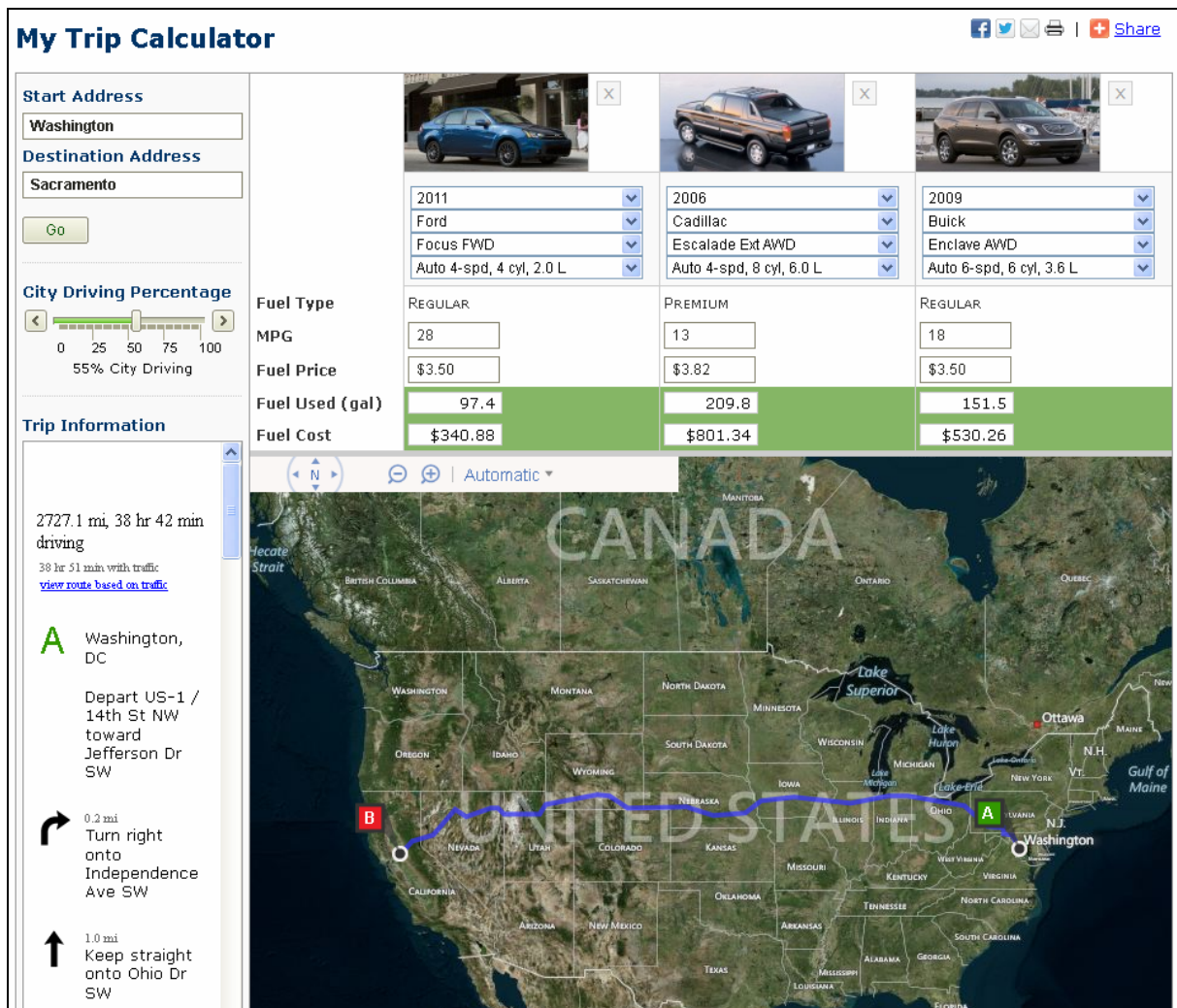


Figure 3. Trip Calculator with 'Fuel Used' view

### Satellite Vehicle Tracking

MIT Technology Review has published the latest achievements in the field of satellite following the path and fuel economy through active vehicle directing [10]: for instance, a route-planning system developed by German manufacturer Bosch makes significant fuel savings on a journey by taking into account the following factors: car's weight, aerodynamics, engine size, transmission and even driver aggression level. This new ECO2 satnav software is said to be able to reduce fuel consumption by 9 percent on average while increasing the average journey time by only 9 percent.

Currently existing satnav systems like TomTom [11] and Garmin [12] devices calculate fuel-efficient routes according to the speed limits of particular roads, as well as the number and type of intersections along the path. However, the route may not be the same for all vehicles and drivers, given that some vehicles are more efficient at accelerating than others. For instance, a route that provides greater fuel economy for a more cautious driver may not be the best choice for one who prefers to drive faster. This, of course, depends on the car's most fuel-efficient speed.

Driving styles that can be selected with the ECO2 software are: fast, normal, or economical, which influences the operation of the algorithm while calculating the most economical route for the chosen driving style.

This software is designed to access the car's specifications through connecting to its central computer. The details in question are engine size, type of fuel and transmission, as well as air and roll resistance (the amount of tire dragging and the way of car handling in turns). From this, ECO2 determines 'speed-dependent fuel consumption curves', i.e. how much fuel the vehicle consumes under different driving and road conditions.

## CONCLUSION

This paper showed the search algorithm theoretical basis. Based on this, the parameters – options for doing a search were analyzed. Nowadays, finding the shortest path gets another aspect – finding the way with the greatest fuel economy. Based on this, an analysis and comparison of route planners was conveyed. The last chapter of the paper shows The official U.S. government source for fuel economy information, as well as the MIT Technology Review report.

The difference between static planner and direct satellite tracking is evident. This comes as the result of the satellite ability to additionally track the vehicle's performance and driving style. This savings difference is reflected in up to 9% fuel savings.

On the basis of the presented material, a significant development of path finding algorithm can be pointed out, as well as the algorithms for choosing the vehicle and driving style which should result in fuel economy.

## REFERENCES

- [1] Peter Sanders and Dominik Schultes, Engineering Fast Route Planning Algorithms, <http://algo2.iti.kit.edu/documents/routeplanning/weaOverview.pdf>, 2013.
- [2] Logan B., AI Programming Techniques, School of Computer Science, <http://www.cs.nott.ac.uk/~bsl/G52APT/slides/08-Depth-first-search.pdf>, 2013.
- [3] Hotomski P., Sistemi veštačke inteligencije, Tehnički fakultet »Mihajlo Pupin«, Zrenjanin, 2006.
- [4] Kamran Zaheer, Artificial Intelligence Search Algorithms In Travel Planning, Master thesis, <http://www.idt.mdh.se/utbildning/exjobb/files/TR0653.pdf>, Mälardalen University Sweden, 2013.
- [5] Dominik Schultes, Route Planning in Road Networks, [http://algo2.iti.kit.edu/schultes/hwy/schultes\\_diss.pdf](http://algo2.iti.kit.edu/schultes/hwy/schultes_diss.pdf), 2013.
- [6] Dijkstra, E.W.: A note on two problems in connexion with graphs. *Numerische Mathematik* 1, 269–271, 1959.
- [7] AA Route planner, <http://www.theaa.com/route-planner/index.jsp>, 2013.
- [8] ViaMichelin Maps and Routes, <http://www.viamichelin.com/web/Routes>, 2013.
- [9] The official U.S. government source for fuel economy information, <http://www.fueleconomy.gov/trip/>, 2013.
- [10] MIT Technology Review, <http://www.technologyreview.com/news/419370/a-more-fuel-efficient-route-planner/>, 2010.
- [11] TomTom International BV, [http://www.tomtom.com/en\\_gb/](http://www.tomtom.com/en_gb/), 2013.
- [12] Garmin Ltd., <http://www.garmin.com/en-US>, 2013.

## APPLICATION OF WIRELESS SENSOR NETWORKS IN INDUSTRIAL SYSTEMS

**Dalibor Dobrilović, Vladimir Šinik**

University of Novi Sad, Technical Faculty "Mihajlo Pupin", Zrenjanin  
e-mail: ddobrilo@tfzr.rs; sinik.vladimir@gmail.com

**Abstract:** The Wireless Sensor Networks (WSN) made major breakthrough in ICT sector in last decade. WSN consists of spatially distributed autonomous sensors. These sensors are generally used to monitor physical or environmental conditions and to transfer these data through wireless network to a main location. The area of usage of WSN is very wide, ranging from agriculture (smart farming), construction (smart home and smart buildings), environmental monitoring (smart cities, air pollution) to industrial control and monitoring. This paper presents the variety of WSN technologies applicable in industrial systems, the basic of this technologies and as well as one simple example of its usage in industrial systems.

**Key words:** WSN, Wireless Sensor Networks, ZigBee, IEEE 802.15.4, WirelessHART

### INTRODUCTION

In past decade Wireless Sensor Networks (WSN) made major breakthrough in ICT sector and there is evident growth of usage of this technologies in various segments of our society. Generally, WSN consists of distributed autonomous sensors connected in wireless network. These sensors are generally used to monitor physical or environmental conditions and to transfer these data through wireless network to a main location. The area of usage of WSN is very wide, ranging from agriculture (smart farming, Irrigation Systems), construction (smart home, smart buildings, security systems, light control systems, multi zone HVAC Systems), environmental monitoring (smart cities, air and water pollution), health-care to industrial monitoring, remote control and automation.

This paper presents the variety of WSN technologies applicable in industrial systems, the basic of this technologies and as well as one simple example of its usage in industrial systems. This paper is structured as follows. After the introduction, the section presents the basic of WSN and variety of WSN technologies. The third section presents vital components of WSN. Fourth section presents one simple example of usage of WSN in industrial monitoring. At the end the conclusion and further work is presented.

### WIRELESS SENSOR NETWORKS

Wireless Sensor Networks (WSNs) can be defined as a self-configured and infrastructureless wireless networks to monitor physical or environmental conditions, such as temperature, sound, vibration, pressure, motion or pollutants and to cooperatively pass their data through the network to a main location or sink where the data can be observed and analyzed. A sink or base station acts like an interface between users and the network. [1]

WSN can contain hundreds of thousands of sensor nodes and the sensor nodes can communicate among themselves using radio signals. A wireless sensor node is equipped with sensing and computing devices, radio transceivers and power components and as constraints they have limited processing speed, storage capacity, and communication bandwidth. Wireless sensor devices can be equipped with actuators to "act" upon certain conditions. These networks are sometimes more specifically referred as Wireless Sensor and Actuator Networks [1].

The major concerns within researches connected to Wireless Sensor Networks is to ensure energy efficient, low cost devices capable to communicate via wireless technology and to transmits data at relatively low speeds. The long battery duration, long operation time and optimization of transferred data have very important role in this research.



## WIRELESS SENSOR NETWORK STANDARDS

There are varieties of standards applicable in the WSN. In this section some of the most important standards will be presented.

### ZigBee

ZigBee standard defines a set of communication protocols for low-data-rate short-range wireless networking [1] and operates in 868 MHz, 915 MHz and 2.4 GHz frequency bands. The maximum data rate is 250 Kbits per second. ZigBee is designed for battery-powered applications with low data rate and when low cost and long battery life are main requirements.

The ZigBee standard is developed by the ZigBee Alliance [2,4]. The ZigBee alliance is composed of hundreds of member companies, from the semiconductor industry and software developers to original equipment manufacturers (OEMs) and installers. The alliance is formed in 2002 as a nonprofit organization. The ZigBee standard has adopted IEEE 802.15.4 as its Physical Layer (PHY) and Medium Access Control (MAC) protocols [2]. Therefore, a ZigBee-compliant device is compliant with the IEEE 802.15.4 standard as well.

The application of ZigBee technology can be:

- Building Automation
- Remote Control
- Smart Energy
- Health Care
- Telecom Services
- Industrial Control and Monitoring

### *Device Types and Roles*

There are two types of devices in an IEEE 802.15.4 wireless network: full-function devices (FFDs) and reduced-function devices (RFDs). FFD can communicate with any other device in a network, but an RFD can talk only with an FFD device. RFD performs very simple applications such as turning on or off a switch and have less processing power and memory size comparing to FFD devices.

In an IEEE 802.15.4 network, an FFD device can take three different roles: coordinator, PAN coordinator, and device. A coordinator is an FFD device that is capable of relaying messages. If the coordinator is also the principal controller of a personal area network (PAN), it is called a PAN coordinator. If a device is not acting as a coordinator, it is simply called a device. The ZigBee standard uses slightly different terminology. A ZigBee coordinator is an IEEE 802.15.4 PAN coordinator. A ZigBee router is a device that can act as an IEEE 802.15.4 coordinator. Finally, a ZigBee end device is a device that is neither a coordinator nor a router. A ZigBee end device has the least memory size and fewest processing capabilities and features. An end device is normally the least expensive device in the network [1].

ZigBee is not the only standard that adopts the IEEE 802.15.4 PHY and MAC layers. 6LoWPAN and WirelessHART also use the IEEE 802.15.4 PHY and MAC layers as part of their wireless networking protocol.

### IPv6 over IEEE 802.15.4 (6LoWPAN)

6LoWPAN (IPv6 over low-power WPAN) standard allows transmission of IPv6 packets over an IEEE 802.15.4 network. The Internet Protocol (IP) version 6 (IPv6) [1] is a protocol developed by the Internet Engineering Task Force (IETF) [7]. Its goal is to replace IP version 4 (IPv4). One of the major improvements in IPv6 compared to IPv4 is the address space. IPv4 supports 32-bit addressing. The expansion of Internet and increasing number of computers connected to Internet caused the shortage in the IPv4 address space. The smaller number of free Internet address, become problem for further expansion of Internet. IPv6 is designed to fix this issue by supporting 128-bit addressing instead of 32-bit addressing. This significantly increased the address space.

There is a wide range of interesting applications where 6LoWPAN technology may be applicable, for example [6]:

- home and building automation,
- healthcare automation and logistics,
- personal health and fitness,
- improved energy efficiency,
- industrial automation,
- smart metering and smart grid infrastructures,
- real-time environmental monitoring and forecasting,
- better security systems and less harmful defense systems,
- more flexible RFID infrastructures and uses,
- asset management and logistics and
- vehicular automation.

### **WirelessHART**

Highway Addressable Remote Transducer (HART) is a communications protocol for applications such as process control, equipment and process monitoring, advanced diagnostics, and closed loop control in wired industrial networks. HART supports a data rate of 1.2 Kbps using FSK modulation. HART uses a master/slave mechanism, and a slave device only transmits data when it is asked by a master device. HART is widely used in process control applications, but it is limited to wired networks.[2]

Wireless HART is a wireless networking standard based on HART that adds wireless flexibility to an existing HART network. WirelessHART operates at the 2.4 GHz ISM band and is backward compatible with existing HART devices, commands, and tools [2]. WirelessHART supports mesh networking. For security, WirelessHART uses AES-128 block ciphers similar to the ZigBee standard. Like wired HART technology, WirelessHART therefore supports the full range of process monitoring and control applications, including:

- Equipment and process monitoring
- Environmental monitoring, energy management, regulatory compliance
- Asset management, predictive maintenance, advanced diagnostics
- Closed-loop control (when appropriate)

Components of WirelessHART technology are [8]:

- gateway - provides the connection to the host network such as Modbus – Profibus – Ethernet,
- network manager - builds and maintains the MESH network,
- security manager - manages and distributes security encryption keys and holds the list of authorized devices to join the network,
- process includes measuring devices – the HART-enabled instrumentation,
- repeater - routes WirelessHART messages and extends the range of a WirelessHART network,
- adapter - device which plugs into an existing HART-enabled instrument to pass the instrument data through a WirelessHART network to the host and
- handheld terminal - may come in two versions, like standard HART FSK configuration unit with WirelessHART connection to the gateway and then down to an instrument and could be used for reading PV or diagnostics.

### **Z-wave**

Z-wave is a wireless networking protocol developed by Z-wave alliance for 900MHz ISM band [2,4]. Unlike ZigBee, Z-wave defines all protocol layers and does not adopt IEEE 802.15.4 PHY and MAC layers. Z-wave supports 9.6 Kbps and 40 Kbps data rates using frequency shift keying (FSK) modulation. The Z-wave signals are narrowband, and no spreading method such as DSSS or FHSS is used to help Z-wave mitigate the presence of interferences and multipath nulls.

One of the differentiating factors between ZigBee and Z-wave is address space. ZigBee supports 64-bit and 16-bit addressing. Z-wave supports only 8-bit addressing, so in a single Z-wave network, there can be up to 232 nodes which are sufficient in many applications. In the case when larger number of

nodes is required, a ZigBee network can be a better alternative because even in 16-bit short addressing, there can be up to 65,536 nodes. In Z-wave, as addition to the 16-bit address each network is identified by a 32-bit value called HomeID. Both Z-wave and ZigBee, supports mesh networking, broadcasting, and multicasting.

Applications of Z-Wave technology are presented at Fig. 1.



Figure 1. Z-Wave technology application

### EXAMPLE OF ZIGBEE TECHNOLOGY USAGE

Although there is a significant advance to use WirelessHART technology instead of ZigBee in industrial application [10] the ZigBee has a lot to offer industrial automation applications. Zigbee is suitable for industry utilization because of: low cost deployment and redeployment, support of mesh networking in order to cover entire industrial plants and factories, open standard with multiple vendors and battery operation (autonomous functionality). ZigBee is able to provide control functionality in systems where certain levels of latency can be tolerated (250Kbps data rate, < 10msec per hop). ZigBee will be used for monitoring where control can tolerate only extremely low latencies. The advances of ZigBee are: low costs of devices that are generally less expensive than sensors and signal conditioners, ease of deployment, multi-vendor products, battery operations that allows sensors to be placed anywhere.

ZigBee can be used in industry in combination with collection of controllers, sensors and actuators working in concert to implement monitor and control a discrete or continuous processes. The varieties of devices operable with ZigBee technology are:

- Controllers: Central and/or Distributed PLCs
- Sensors: Temperature, Acoustic, Pressure, Strain, Vibration, etc.
- Actuators: Valves, Motors, Solenoids, Relays
- PLCs running ladder logic programs implement state machines that change outputs based on the state of sensor inputs
- Sensor inputs and PLC outputs are made available to monitoring programs
- Alarms are generated when process variables exceed preset levels

In this paper will be presented the usage of DTK Electronics ZigBee device DRF2618A [12] in wireless transmission of sensor data.

Table 1. Electronic parameters of DRF2618A device

Parameter	Value
Power	USB port – 5V
Temperature range	-40°C~85°C
UART Baud Rate	38400bps, 9600bps, 19200bps, 38400bps, 57600bps, 115200bps
Radio Frequency	2460Mhz, 2405MHz-2480MHz, Step: 5MHz
Protocol	ZigBee2007
Distance	1600m, clear sight
Operating Current	Send 120mA max, receive 45 mA max, Standby 40 Ma max.
Receiving sensitivity	-110dBm
Chip	CC2530F256, 256KFLASH
Configuration Mode	Coordinator, Router
Interface	RS232, 2-TX, 3-RX, 5- GND
Size	70-50-24mm

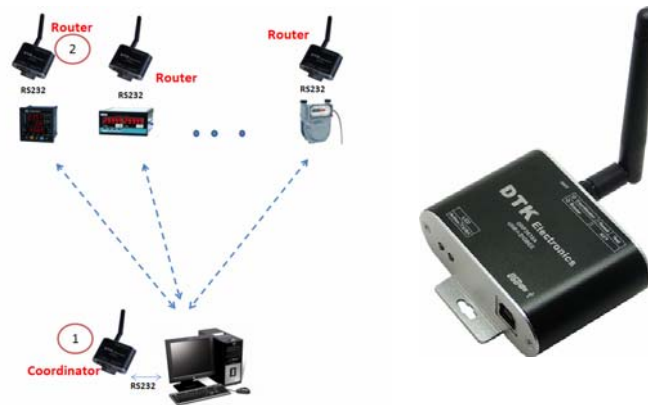


Figure 2. DTK DRF2618A device and its appliance in industrial environment

## RESULTS AND DISCUSSION

The experiment was conducted with two DTK Electronics DRF2618A devices. One set as ZigBee coordinator and one set as ZigBee router. Operating channel is set to 11 and operating frequency is set to 2405 MHz. Both devices are connected to two separated laptop computers with USB Type A – Type B cables. The transfer of data between two computers is accomplished with usage of SSCOM 3.2, freeware software for serial communication. This software is used to send data to ZigBee router device and to receive transmitted data to laptop on the end of link. The data that were sent for every 1000ms and were in the form of string:

QFF,26.80,100533,25.40,45.52,em

This data format simulates the data sent from remote sensor station with two sensors. One sensor is BMP085 [13] for sensing barometric pressure and temperature, and the second one is DHT22 [14] for sensing temperature and humidity. The forms of sent data correspond to the following values:

- Code of sensor station
- Temperature in Celsius degrees measured with BMP085 sensor
- Barometric Pleasure in Pascal measured with BMP085 sensor
- Temperature in Celsius degrees measured with DHT22 sensor
- Humidity in percent measured with DHT22 sensor
- End of message delimiter

The values are separated with “,” to be in accordance with CSV file format and more suitable for further processing. Two devices are positioned at the distance of approximately 10m in separate rooms, divided with two standard brick walls. Packets were captured using Texas Instruments CC2531 USB Dongle and Texas Instruments SmartRF Protocol Packet Sniffer software package. During the experiment the following results, were collected (Table 2).

Table 2. Experiment results

Parameter	Value
SSCOM bytes send	48741
SSCOM bytes received	40708
SSCOM packets send	1477
SSCOM packets received	1234
RSSI (dBm)	-68 to -80
TI SmartRF packets captured	2961
TI SmartRF packet errors	2
Operating channel	11 (0x0B)
Raw data length (bytes)	33
DATA packet length (bytes)	60
ACK packet length (bytes)	5
Data transfer time (sec)	47892.018
Average packets/sec	0.062
Average packet size (bytes)	32.424
Total bytes	96041
Average bytes/sec	2.005

## CONCLUSION

This paper presented the usage of various Wireless Sensor Network technologies in industrial systems. Some of WSN technologies are more applicable in industrial and some are more applicable in other environments. One example of usage of ZigBee technology devices for sensor data transfer was presented in this paper as well. The simulation experiment was made for situation of remote sensing the temperature, humidity and barometric pressure parameters, a sending this data to the remote central location with wireless technology. Results showed the applicability of ZigBee technology for sending data of remote sensor in indoor environments and its efficiency for remote system monitoring. The further work on this topic will include experiments with mesh networked multiple devices and usage of multiple sensors. Also, the impact of wider building and outdoor connectivity on data transfer will be examined as well. Combination of ZigBee with RFID, 3G, Ethernet and other technologies will be also in the focus of further research.

## REFERENCES

- [1] A. Marin (Editor), *Wireless Sensor Networks – Technology and Protocols*, InTech, Rijeka, Croatia, 2012
- [2] Shahin Farahani, “ZigBee Wireless Networks and Transceivers”, Elsevier Ltd., Burlington, USA 2008.
- [3] Edgar H. Callaway, "Wireless Sensor Networks: Architectures and Protocols", CRC Press, 2004.
- [4] Robert Faludi, *Building Wireless Sensor Networks*, O'Reilly Media, Inc., USA, 2011.
- [5] Ipv6 over IEEE 802.15.4 (6LoWPAN), available at <http://6lowpan.net/>,
- [6] Zach Shelby, Carsten Bormann, *6LoWPAN: The Wireless Embedded Internet*, John Wiley & Sons Ltd, Chichester, UK, 2009.
- [7] Internet Engineering Task Force (IETF), available at [www.ietf.org](http://www.ietf.org)
- [8] WirelessHART, [www.hartcomm.org](http://www.hartcomm.org), retrieved September 2013.
- [9] Z-wave Alliance, available at [www.z-wavealliance.org](http://www.z-wavealliance.org), retrieved September 2013.
- [10] Tomas Lennvall, Stefan Svensson, Fredrik Hekland, A Comparison of WirelessHART and ZigBee for Industrial Applications, IEEE International Workshop on Factory Communication Systems WFCS 2008, 21-23 May, Dresden, Germany, 2008.
- [11] DTK Electronics, available at <http://www.dtkcn.com/>, retrieved September 2013.
- [12] Digital-output relative humidity & temperature sensor/module DHT22 (DHT22 also named as AM2302), <https://www.sparkfun.com/datasheets/Sensors/Temperature/DHT22.pdf> retrieved September 2013.
- [13] BMP085 Digital Pressure Sensor, Data Sheet, Bosch Sensortech, <https://www.sparkfun.com/datasheets/Components/General/BST-BMP085-DS000-05.pdf>, retrieved September 2013.

## **SESSION 8: Biotechnology**

## USE OF BIOMASS AS A RENEWABLE ENERGY SOURCE IN SERBIA

Emina Mihajlović, Jasmina Radosavljević, Miomir Raos, Ljiljana Živković, Nenad Živković

University in Niš, Faculty of Occupational Safety, Niš, Serbia  
e-mail: emina.mihajlovic@znrfak.ni.ac.rs

**Abstract:** Serbia is abundant in biomass for energy use. Unfortunately, biomass is not sufficiently used for energy purposes, although its use would help realize the strategy of environmental protection and sustainable development. This paper presents some of the results of biomass briquetting conducted at the Faculty of Occupational Safety in Niš, or more specifically – on the identification of technological parameters of the briquetting of waste biomass such as: biomass humidity and granulation, minimal pressure of formation, type and minimal participation of binding substance, and the possibility to design bio-briquettes with predetermined physicochemical and energy properties.

**Key words:** biomass, bio-briquettes, environmental protection, sustainable development

### INTRODUCTION

The use of biomass, as the first and oldest energy source, for energy purposes is becoming increasingly prominent because biomass implies the following [3]:

- it represents a renewable source of energy, i.e. fuel that is constantly generated and as such is practically inexhaustible;
- from the ecological point of view, its use affects the environment because it does not contain sulfur, so the gaseous products do not contain sulfur dioxide and there are no emissions of hydrocarbons as incomplete products of combustion;
- it meets the criteria of a closed system with respect to the emitted carbon dioxide and solid combustion products. Carbon dioxide produced by the combustion of biomass will be absorbed by the plants through photosynthesis, and the ashes will participate as fertilizer in the production of biomass. If the cutting and growth of biomass are in a sustainable relationship, the system can be considered a closed one.

On the other hand, its use for energy purposes would create new jobs and accelerate the overall progress of villages, towns, local communities, and all of Serbia.

Thus, thermal energy from biomass fits into sustainable development from the perspective of economic sustainability and production and environmental protection, and from social perspective in terms of social stability, creation of jobs, and reduction of energy imports.

### BIOMASS AS FUEL

Biomass can be defined as:

- one of the transformed forms of solar energy,
- a product obtained through photosynthesis,
- the remains from cultivated and non-cultivated areas after crop harvesting,

while **biofuel** represents only the biomass that would produce a certain amount of heat during combustion for rational and appropriate use, provided that all additional requirements for a combustible material to be considered a fuel are met.

Biomass utilization for food and feed from cultivated areas is 20 [%] and from non-cultivated areas only 1 [%], which means that there is enough biomass for energy use.

Biomass is used as fuel [3,4]:

- 1) by direct combustion in its original form or in bales,
- 2) in the form of bio-briquettes, and

3) as a processed solid, liquid, or gaseous fuel derived from: carbonization, gasification, hydrocracking, fermentation by anaerobic bacteria, and fermentation of biomass.

## BIOMASS OF SERBIA

The total biomass potential of Serbia from agriculture only, which primarily refers to plant residues from agriculture, fruit growing, and viticulture, is  $12.5 \times 10^9$  [t/year].

All representatives of Serbian biomass can be classified into the following groups [3,4,5,6]:

1) **Biomass as waste from agricultural production:** wheat, barley, oats, rye, soybean, and canola straw, corn cobs, and corn shucks. With some minor variations, it can be assumed that in Serbia it amounts to ca.  $29.9 \times 10^6$  [t/year], of which 77.6 [%] is privately owned. In the territory of Serbia without provinces, it is  $10.22 \times 10^6$  [t/year], of which 95.3 [%] is privately owned.

2) **Biomass as waste of industrial plants:** sunflower seed husk, waste from hop and tobacco processing, husks and other waste from the processing of rice, hemp, cotton, soybean, flax, etc. It can be assumed that in Serbia it amounts to ca.  $34.25 \times 10^5$  [t/year]. With this type of biomass concessions should be made with regard to the production of stock feed, but if it becomes a burden or an environmental issue, it should be used as fuel.

3) **Forest biomass** refers to stem wood thicker than 7 [cm], brushwood, and stumps. There is no reliable data about the manner and structure of deforestation in Serbia. The Serbian Statistical Office only provides information about the cutting of state forests. During forest cutting technical and stacked wood are separated, while the waste remains in the forest. The waste makes up 15-18 [%], whereby the brushwood, stumps, and roots are not taken into account. Per 100 [m<sup>3</sup>] of cut forest, there are 15 [m<sup>3</sup>] of brushwood and 15 [m<sup>3</sup>] of stumps and roots, making a total of about 30 [%] and, together with the waste, 45 [%] of the total wood mass, or even 50 [%] if we consider that up to 5 [%] is made up of leaves and conifer needles [1].

4) **Residues from the wood processing industry.** They can originate from mechanical and chemical processes. Wood waste in the industrial processing of wood constitutes up to 65 [%] of wood mass [1].

5) **Biomass waste from fruit growing and viticulture.** The main representatives are pruning remains from orchards (raspberry, blackberry, and blueberry plantations), pruning remains from vineyards, husks, and pits. This biomass amounts to ca. 408,279 [m<sup>3</sup>/year] [5].

6) **Biomass from uncultivated land.** Unfortunately, there are no statistics on the annual mass or volume increase of this type of biomass.

7) **Biomass from special energy surfaces.** Unfortunately, this mode of production of "energy forests" is under-researched in Serbia, although it is very popular in other parts of the world. Fast-growing trees are planted in special areas and the period from their planting to their harvesting ranges from 6 to 12 years. The yield from these areas is between 10 and 15 [t] per hectare per year [3]. Fast-growing tree species are the poplar, the willow, the eucalyptus, etc., obtained by special breeding methods [3]. Use of these energy forests would reduce consumption of fossil fuels and the amount of harmful substances in waste water, soil, and the air, and would expand the variety of crop plants.



## BIOMASS THROUGHOUT THE WORLD

Biomass is the fourth largest source of energy in the world. It is estimated that in the year 2050 biomass will cover 38 [%] of the demand for energy fuel and 17 [%] of electricity demand. In developing countries, biomass covers about 40 [%] of energy demand, with inefficient combustion, where only 5-15 [%] of available energy is utilized [3].

In 2002, Finland covered about 18% of its energy demand with biomass, and in 2006 this went to 25 [%]. Austria covers 80 [%] of its energy demand with renewable energy, and biomass has the largest share. In Sweden, biomass covers nearly 20 [%] of energy demand, aided by well-designed cogeneration plants, which produce both heat and electricity. In Slovenia, in the municipality of Vranksko, a district heating system was constructed with two biomass boilers of 2 and 1.2 [MW]. The project was financially supported by the Slovenian Government, the World Bank, and the Slovenian Ministry of the Environment [3].

The results of the research at the Faculty of Occupational Safety in the production of briquettes from waste biomass

### Research material

For the experimental work for the development of waste biomass briquettes we used the following [2]:

1 Acacia - brushwood	12. Corn - shacks, cobs, and stems
2 Pine - needles and cones	13. Rice - husks
3 Peach - pits	14. Raspberry – pruning remains
4 Beech - sawdust and chips	15. Timber bark
5 Turkey oak - sawdust	16. Walnut - shells
6 Tobacco - dust and scraps	17. Grape peduncles
7 Oak - brushwood and sawdust	18. Wheat straw
8 Ash - chips	19. Sunflower – husks and stems
9 Fir - chips and cones	20. Bulrush
10. Hemp - stems	21. Reed - stems
11. Cherry - pits, whole and ground	22. Willow - brushwood

To the basic material – waste biomass – we added the binding materials, which had been particularly studied in order to reduce pressure in the formation of briquettes, to obtain briquettes with high humidity, and to obtain special effects during combustion.

The binding materials include organic or inorganic substances, which a property that, after mixing with the briquetting material, bonding, and hardening, they bind the particles of a briquetted material, providing it with satisfactory strength and durability. Currently, the briquetting process mostly equally utilizes organic and inorganic binders, with a stronger tendency towards non-organic binders.

### Production method

Laboratory production of briquettes involved the following equipment:

- I) laboratory manual press and
- II) hydraulic press with extrusion [4].

### Research results

At the Faculty of Occupational Safety in Niš, we obtained a series of briquettes from waste biomass (1) with binder, the so-called composite bio-briquettes, and (2) without a binder, the so-called solitary bio-briquettes. Their representatives are shown in Table 1.

**Table 1.** Summary of the technological parameters of biomass briquetting obtained at the Faculty of Occupational Safety in Niš [2]

No	Technological process of briquetting	Type of biomass	Binder	Binder share [-]	Formation pressure [MPa]	Density [kg/m <sup>3</sup> ]	Granules of biomass	Moisture [%]	Calorific value [MJ/kg]
1.	Dry without binder	Beech - sawdust	-	0	20	1050	0 - 3	6.6	15.15
2.	Dry without binder	Beech - scraps	-	0	20	1083	0 - 10	6.7	15.15
3.	Dry without binder	Turkey oak - sawdust	-	0	20	1062	0 - 3	6.5	15.4
4.	Dry without binder	Fir - sawdust	-	0	20	1041	0 - 3	6.5	16.9
5.	Dry without binder	Ash - chips	-	0	20	1122	0 - 10	6.2	15.3
6.	Dry without binder	Wheat straw	-	0	20	1015	0 - 10	6.2	15.4
7.	Wet with binder	Vine – pruning remains	Paper pulp	0.5	0.3 - 0.5	500	φ 10 x 15	5.422	17.5
8.	Wet with binder	Vine - pomace		0.5	0.3 - 0.5	500	natural size	5.398	18.28
9.	Wet with binder	Walnut - shells		0.5	0.3 - 0.5	420	natural size.	13.25	17.6
10.	Wet with binder	Cherries - pits		0.2	0.3 - 0.5	481	natural size	7.475	-
11.	Wet with binder	Beech - sawdust		0.5	0.3 - 0.5	380	0 - 3	6.675	17.28
12.	Wet with binder	Cherries - pits	Semi cellulose	0.3	0.583	502	natural size	7.475	37
13.	Wet with binder	Vine - pomace		0.3	0.583	380	natural size	6.712	38
14.	Wet with binder	Vine – fermented pomace		0.3	0.583	390	natural size	6.712	39
15.	Wet with binder	Peach - pits		0.5	0.583	370	natural size	-	40
16.	Dry with binder	Beech - sawdust	Paraffin hydrocarbons	0.4	25	760	2 - 15	Up to 7	26
17.	Dry with binder	Sunflower husks		0.4	25	630	5 - 8	Up to 7	28
18.	Dry with binder	Grape peduncles		0.4	25	900	Up to 15	Up to 7	21
19.	Dry with binder	Beech sawdust	Guar flour	0.02	6.25	285	0 – 2	42	16
20.	Dry with binder	Beech sawdust	Modified starch	0.1	8	376	0 – 2	42	16
21.	Dry with binder	Beech sawdust	Carboxymethyl cellulose	0.1	9	487	0 – 2	42	16
22.	Dry with binder	Beech sawdust	Dinkol	0.15	7	303	0 – 2	42	16
23.	Dry with binder	Beech sawdust	Glue	0.1	9	567	0 – 2	42	16
24.	Dry with binder	Beech sawdust	Gypsum	0.3	6.2	539	0 – 2	42	15.5
25.	Dry with binder	Beech sawdust	Water glass	0.2	7	324	0 – 2	42	15.5
26.	Dry with binder	Timber bark	Gypsum	0.08	5	252	Up to 1 000	40	-

### Bio-briquettes with predefined physical and chemical properties

A special group of briquettes made from waste biomass involves briquettes with predefined physical and chemical properties obtained by briquetting a mixture of chopped biomass, binding material, and additives. This purpose-briquette made for combustion in fireplaces belongs to composite energy briquettes and meets the following requirements [4]:

- 1 it is made from waste biomass (in order to protect plant species and biodiversity)
- 2 it is easy to manipulate and use directly with the packaging (e.g. paper)
- 3 it has a calorific value of 20 to 30 [MJ/kg]
- 4 during combustion it forms a high diffusion flame, about 0.5 [m], preferably with special colour effects and possibly with emission of aerosols with corresponding pleasant smells,
- 5 combustion time between firings is comparatively long, min. 2 [h]
- 6 it has a minimal amount of solid combustion products and the firebox is rarely cleaned,
- 7 environmentally, it has a "good" composition of gaseous products of combustion, and
- 8 its use is exclusive to dedicated rooms with fireplaces (living room, mountain homes, houses, hotels with lounges, and reactivated objects of historical and cultural significance with traditional heating).

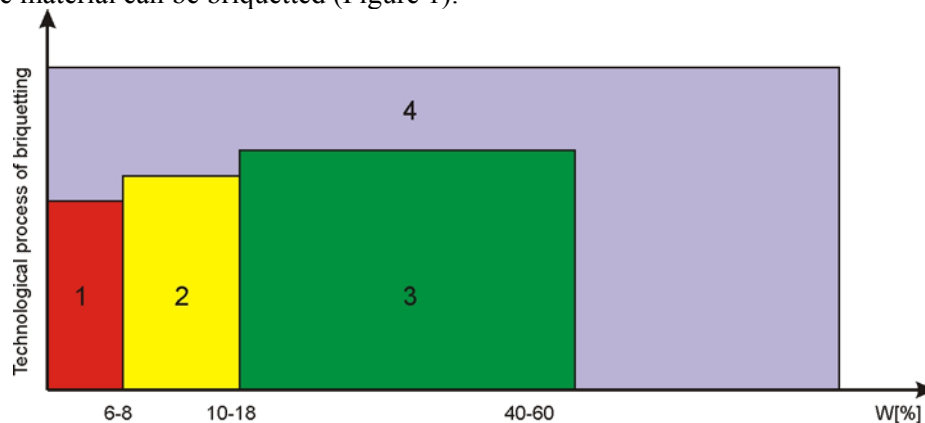
At the Faculty of Occupational Safety, we produced 68 different types of fireplace bio-briquettes [4]. The process of fireplace briquette combustion was examined on a laboratory tripod (the effects: emission of smell during combustion, coloured and sparkling flame) and in an everglowing fireplace manufactured by "Alfa Plam", Vranje (impacts: of the diameter of briquettes on the flame height and excess air ratio, the share of the binders, the temperature of combustion products and types of biomass) [4].

### CONCLUSION

The research at the Faculty of Occupational Safety in Niš so far involved the following:

- analysis of existing technology of briquette manufacturing and
- successful use of briquetting technology with and without binder in dry and wet briquetting.

It can be concluded that during briquetting, moisture and biomass granules are no longer the limiting factors and that, with careful selection of the technological process and the type of binder, any combustible material can be briquetted (Figure 1).



**Figure 1.** Connection between moisture content and the used technological process of briquetting: 1. Dry with binder, 2. Dry without binder, 3. Dry with binder, 4. Wet technological process of briquetting [2]

On the basis of the experimental work conducted at the Faculty of Occupational Safety in Niš on obtaining bio-briquettes for fireplaces with a set of physicochemical and energy properties, we can conclude that [4]:

- addition of specific types of binders in precisely calculated mass ratios results in calorific values from 20 to 30 [MJ/kg];
- addition of additives for pleasant smell yields better environmental conditions;
- addition of additives for flame colouring and sparkling produces beautiful and attractive visual effects;
- combustion creates a beautiful diffusion flame, whereby the most heat is transferred by radiation (Fig. 8); fireplace ashtray cleaning is rare as the maximum ash content was measured in the briquette from rice husks, 15 [%]; and
- combustion creates no harmful products in fireplaces with a firebox deeper than 900 [mm].



**Figure 2.** Combustion of fireplace bio-briquettes made of beech sawdust (weighing 433.9 g) in a fireplace manufactured by "Alfa Plam", Vranje [4]

## REFERENCES

- [1] Danon, G., Biomass in forestry and wood processing, Proceedings: Briquetting and pelleting of biomass from agriculture and forestry, Executive Council of the Autonomous Province of Vojvodina, Regional Chamber of Commerce Sombor, LLC "Dakom" APATIN, Sombor, 1998.
- [2] Mihajlović, E., Mitić, D., Stojiljković, M., Development and design of machinery and technology for dry and wet briquetting and pelleting, ISSN 0354-9836, categorized as an original scientific paper, Thermal Science, No. 4, vol.10, pp. 131-143, 2006.
- [3] Mihajlović, E., Biomass as a potential renewable energy source, Journal of Agronomic Findings, ISSN 0354-2092, UDC 620.95:504, No. 5, pp. 27-30, 2006.
- [4] Mihajlovic, E., Exploring composite bio-briquettes with a set of physicochemical and energy properties, PhD thesis, Faculty of Occupational Safety, Niš, 2003.
- [5] Mitić, D., Biomass and bio-briquettes of Serbia – potential ecological fuels, Monograph, Yugoslav Society of Processing and Energy in Agriculture, Novi Sad and the Yugoslav Association of Safety Engineers and Technicians - Niš, Novi Sad, 1998.
- [6] Oka, S., Jovanović, Lj., Biomass in Energy, Biomass – a renewable energy source, Monograph by a group of authors, Yugoslav Society of Thermal Engineers Belgrade, Belgrade, 1997.

## ANALYSIS OF CHEMICAL AND THERMAL QUALITY INDICATORS OF BIOMASS ENERGY PELLETS

Zorica Gluvakov<sup>1</sup>, Miladin Brkić

<sup>1</sup> University of Novi Sad, Faculty of Agriculture, Novi Sad, Serbia

e-mail: [zorica.gluvakov@live.com](mailto:zorica.gluvakov@live.com)

**Abstract:** In this paper, based on European standards, collected literature and existing methods of laboratory testing, results of some chemical and thermal indicators of the quality of the biomass energy pellets after extrusion and cooling the compressed material are shown. Based on existing methods, moisture content, ash content and calorific values of biomass energy pellets were evaluated. Based on test results obtained by a series of data, chemical and thermal characteristics of biomass energy pellets were estimated based on European standards and existing literature. Comparing the results with existing standards and literature sources it can be said that the moisture content, ash content and calorific value are the most significant parameters for quality analysis, which decide on the applicability and practical value of biomass energy pellets as biofuel.

**Key words:** biomass, pellet, moisture content, ash content and calorific value.

### INTRODUCTION

The term "pellet" comes from English and means small balls. Pellet is a smaller body, usually made of pressed material in the form of balls or rollers. It is frequently referred to in the plural, because the pellet is not used as a single piece, but a group of it. They can be made from different products and materials, depending on the type of material or heat treatment. Pellets as fuels can be made of wood, plant biomass or waste (Obenberger and Thek, 2009). So, pelleting process involves compression or pressing of chopped roughage plant material in a convenient form, which has a significantly smaller volume compared to the initial raw material (Brkić et al. 2011).

Quality indicators of biomass energy pellets can be divided into chemical and thermal, physical and mechanical properties. The most important chemical and thermal indices are determined by the content of certain chemical components of the pellets, moisture content, ash content and energy value. Chemical and thermal parameters of the pellets quality are determined by the quality of material and pressing process. Physical and mechanical parameters show geometric parameters of pellets, pellet density, abrasion and pressure resistance (Urbanovicová et al, 2011). Chemical and thermal parameters of the pellets quality are determined by the quality of material for pressing. It is possible to lower the humidity in order to increase the quality, but the other parameters are specified by the material (chemical elements in the biomass, ash content, energy value...). Physical and mechanical parameters are influenced by material properties for pressing (firmness of the materials) as well as the use of appropriate technology.

Producers, suppliers and consumers of solid biofuels, biomass energy pellets as well, is necessary to be provide by the system of biofuels quality assurance to be able lead safer business. Thus, quality indicators of the energy biomass pellets are shown in standards for energy pellets and literature sources. The aim of this paper is that, based on European standards, literature sources and laboratory methods examine the quality of chemical and thermal properties, ie. moisture content, ash content and calorific value of the biomass energy pellets and therefore show their dependence.

### MATERIALS AND METHODS

In preparing this paper, energy pellets of different types of raw materials were used as a working material. Raw materials used in production of the final product (pellet) were wheat straw, soybean straw, sunflower husks, cornstalks, beech sawdust and poplar sawdust. Based on these raw materials eighteen different types of energy pellets were produced, derived from three different types raw material: wheat straw, soybean straw, sunflower husks, cornstalks, beech sawdust and poplar sawdust.

The sampling of energy pellets for testing moisture content, heating value and ash content was performed in manufacturing plant for the production of pellets. Sampling method was found in instructions for sampling grain, UP.05.3.002. Collected samples of energy pellets were from 3 to 5 kg and placed in sealed plastic bags and then stored in the refrigerator until testing. The tests were performed within 5 days from the time of sampling to avoid any changes in quality.

The working methods are based on the collection of data for testing of biomass energy pellets from literature, European standards, existing methods and laboratory testing of moisture content, ash content and calorific values, results analysis and drawing conclusions.

### Method for determining the moisture content in energy pellets

The moisture content in the biomass energy pellets means "loss" of the mass fragmented pellet mass lose on drying for 2 hours at temperature 105°C. Moisture content was determined according to the standard SRS E. B8. 012.

From an average sample for determining the moisture content of the biomass energy pellets 20 g is taken and grind. All grist obtained is immediately placed in pre-measured container and quickly measure in order to avoid mass of the sample to absorb the moisture from the air. Pots with grist are than placed in laboratory dryer (Fig. 1), and then dried for 2 h. Drying time is calculated from the moment oven reaches temperature of 105° C. Upon completion of drying, the vials are transferred to the desiccator with protective gloves, where it is cooled to ambient temperature. When the dried sample is cool, it is placed on electric scale and his total weight measured. From the total weight of the sample the mass of the container is subtracted (tara) in order to obtain the net weight of the sample (Gluvakov Zorica et al., 2012).



Figure 1. Laboratory dryer

Moisture content of energy pellets is calculated based on the ratio of the masses, in order to get the weight percentages according to formula:

$$w = \frac{(m_1 - m_2)}{m_1} \times 100$$

where:

w – moisture content (humidity) in percentages, %

m<sub>1</sub> – mass before drying, in g

m<sub>2</sub> – mass after drying, in g.

For each determination of moisture content in biomass pellets at least three simultaneous measurements should be done. Moisture content of the sample is shown as arithmetic mean rounded to two decimals.

### Method for determination of ash content in energy pellets

Ash content of biomass energy pellets in a sample represents the mass of the sample remaining after complete combustion of the sample at a temperature of  $575 \pm 25^\circ \text{C}$ , expressed as a percentage, according to the standard SRS H.N8.136.

From an average sample for determination of the ash content, 20g is taken and chopped finely. Fragmented pieces of the appropriate size are immediately put into a container and carefully burn on the open flame until full carbonation (carbonization of the sample). After a complete combustion of the sample to full carbonization a mixture of ash and coke is obtained. 1 g of combusted sample is taken and put in a cup. The cup is then placed in a furnace, which is gradually heated. Annealing is performed at  $575 \pm 25^\circ \text{C}$  for next 3 hours. During annealing, coke is completely burned. Upon completion of the annealing, pure ash is left. Removing the cup from the electric furnace (Fig. 2) is performed by using a metal "catcher". When removing the cup from the electric furnace it is necessary to first put it on the lid of oven to cool for 15 minutes, to prevent cracking because of large temperature differences. After cooling, the remaining ash is measured on an analytical balance (GluvakovZorica et al, 2012).



Figure 2. Electric furnace

Ash content of biomass energy pellets is calculated as follows: first, the mass of a fragmented sample of energy pellets is measured before combustion, then we measured the mass of cooled mixture of coke and ash, in order to find percentage of a mixture of coke and ash in the total pellet sample. From the total weight of a mixture of coke and ash 1 g of sample is taken for annealing. After annealing, the cooled mass of ash is measured and percentage of ash in 1 g of the sample mixture of coke and ash is calculated. After that, the mass of ash in the total volume of a mixture of coke and ash is determined. Finally, based on the mass of ash in the total volume of the mixture of coke and ash, the percentage of ash in the total mass of the sample pellet of 20 g is determined.

### Method for determining the calorific value of energy pellets

Higher heating power (the value of) energy pellets is determined calorimetrically to the standard EN ISO 1716. 1g of dry milled or whole sample is measured on the analytical balance and placed in a small bowl. Small vessel with the sample is then placed on the upper part (cover) of the "bomb", where electrodes are connected by wire. After that, the "bomb" closes and fill with oxygen up to pressure of 30 bar. Before putting the "bomb" into the calorimeter (Fig. 2) it is necessary to check whether there is water in it, if not it needs to be filled with water and after that the "bomb" is put down into the calorimeter. Electric current is then brought to the "bomb" through the electrodes. The process of total combustion starts in the apparatus. Sample combustion releases a certain amount of heat that the apparatus is recorded and passed on to the computer. After completion of the procedure it is necessary to dismantle "the bomb" and clean the sample container with a brush (GluvakovZorica et al, 2012).



**Figure 3.** Calorimeter

For each determination of the calorific value of the biomass energy pellets at least three measurements should be done and then the average calorific value of the sample is calculated and rounded to two decimal places.

Lower calorific value of the biomass energy pellets is obtained from the form:

$$h_g = h_d + 2500 (9h + w)$$

where:

$h_g$  – upper calorific value (kJ/kg)

$h_d$  – lower calorific value (kJ/kg)

$h$  – amount of water produced by the combustion of hydrogen (kg)

$w$  – moisture content in relative units

## RESULTS AND DISCUSSION

The main results of these studies are obtained by laboratory testing of moisture content, ash content and calorific values of biomass energy pellets. We studied these parameters on energy pellets from wheat straw, soybean straw, sunflower husks, cornstalks, beech sawdust and poplar sawdust. Methods used in these studies are mentioned in section Material and Methods.

The origin of all the materials used in this study is straw, cornstalks, sunflower husk or sawdust, and the structure of the material milled for 3 to 5 mm. The examined energy pellets were cylindrical shape. Diameter of the studied pellets was 6 and 8 mm. The length of all the investigated biomass energy pellets ranges from 5 mm to 50 mm, which indicates the average length of about 27.5 mm.

Table 1 and 2 show the results obtained during tests on three different samples of energy pellets of wheat and soybean straw.

**Table 1.** Test results of energy pellets from wheat straw

No.	Samples	Moist content (%)	Calorific value (MJ/kg)	Ash content (%)
1.	Wheat straw	7.78	15.02	8.53
2.	Wheat straw	7.81	15.25	7.81
3.	Wheat straw	7.73	15.51	6.76
4.	Average	7.77	15.26	7.70

**Table 2.** Test results of energy pellets from soybean straw

No.	Samples	Moist content (%)	Calorific value (MJ/kg)	Ash content (%)
1.	Soybean straw	9.12	14.38	8.63
2.	Soybean straw	7.71	15.41	7.43
3.	Soybean straw	8.01	14.72	8.24
4.	Average	8.28	14.84	8.10



The moisture content of the examined biomass energy pellets from Tables 1 and 2 is within acceptable limits ( $\leq 12\%$ ) DIN standard, EN 14961-1 standard ( $\leq 10\%$  and  $\leq 15\%$ ), ENplus standards ( $\leq 10\%$ ) and in the literature range (7-12%) of average characteristics of pellets.

The moisture content of the examined biomass energy pellets from Tables 1 and 2 is not within acceptable limits DIN standard ( $\leq 1.5\%$ ), ENplus standard ( $\leq 0.7\%$ ,  $\leq 1.5\%$ ,  $\leq 3\%$ ), nor in the literature range (0.4-1.5 %). Ash content of all samples is in the standard values of EN 14691-1 standard ( $0.5 \leq \text{ash} \leq 10$  and  $> 10\%$ ).

Calorific values of the samples from Tables 1 and 2 are not within permitted interval of DIN standard (17.5 to 19.5 MJ / kg), ENplus standard ( $\geq 16.0$  MJ / kg), nor literature sources (from 16.92 to 17.64 MJ / kg). Calorific values in EN 14961-1 standard are not defined, but represent a minimal value that is necessary to identify, as the net calorific value according to EN 14918 standard. It should be noted that the standards of EU countries relate mainly to energy pellets from wood biomass.

Table 3 and 4 show the results obtained during tests on three different samples of energy pellets of cornstalks and sunflower seed shells.

**Table 3.** Test results of energy pellets from cornstalks

No.	Samples	Moist content (%)	Calorific value (MJ/kg)	Ash content (%)
1.	Cornstalks	8.86	14.67	9.21
2.	Cornstalks	11.69	13.93	10.47
3.	Cornstalks	11.31	12.34	11.53
4.	Average	10.62	13.65	10.40

**Table 4.** Test results of energy pellets from sunflower seed shells

No.	Samples	Moist content (%)	Calorific value (MJ/kg)	Ash content (%)
1.	Sunflower husk	12.12	15.08	7.30
2.	Sunflower husk	9.01	16.43	6.29
3.	Sunflower husk	11.03	15.67	7.05
4.	Average	10.72	15.73	6.88

The moisture content of the tested energy pellets from Table 3 and 4 is within acceptable limits of EN 14961-1 standard ( $\leq 10\%$  and  $\leq 15\%$ ), literature range (7-12%) and DIN standards ( $\leq 12\%$ ), except for samples in Table 4 under the number 1. In this sample there are minor variations in moisture content. In other samples, compared to the standard ENplus ( $\leq 10\%$ ), there were more variations. Within limits of ENplus standards are energy pellets of cornstalks under number 1 and energy pellets from sunflower husks under number 2, while other samples from Table 3 (no. 2 and 3) and Table 4 (no. 1 and 3) deviate from the ENplus standards.

Ash content of biomass pellets examined in Table 3 and 4 is not within the allowed limits DIN standard ( $< 1.5\%$ ), ENplus standard ( $\leq 0.7\%$ ,  $\leq 1.5\%$ ,  $\leq 3\%$ ), nor literature sources (0.4-1.5 %). Ash content of all samples is within the standard values of EN 14691-1 standard (from  $\leq 0.5$  to  $\leq 10$  and  $> 10\%$ ).

Calorific values of the samples from Tables 3 and 4 are within allowed limits of DIN standards (17.5 to 19.5 MJ / kg), nor ENplus standard ( $\geq 16.0$  MJ / kg) except the sample of sunflower husk under number 2, nor literature sources (16.92 to 17.64 MJ / kg). Calorific values in EN 14961-1 standards are not defined, but represent a minimum value that is necessary to identify, as the net calorific value according to EN 14918 standards.

Tables 5 and 6 show the results obtained during tests on three different samples of energy pellets of beech and poplar sawdust.

**Table 5.** Test results of energy pellets from beech

No.	Samples	Moist content (%)	Calorific value (MJ/kg)	Ash content (%)
1.	Beech	7.52	16.80	0.64
2.	Beech	7.44	16.68	0.70
3.	Beech	6.45	16.92	0.67
4.	Average	7.14	16.80	0.67

**Table 6.** Test results of energy pellets from poplar

No.	Samples	Moist content (%)	Calorific value (MJ/kg)	Ash content (%)
1.	Poplar	6.23	17.07	0.63
2.	Poplar	6.29	16.85	0.69
3.	Poplar	7.01	16.34	0.71
4.	Average	6.51	16.77	0.68

Moisture content of all examined energy pellets in Tables 5 and 6 is within acceptable limits ( $\leq 12\%$ ) of DIN standard, EN 14961-1 standard ( $\leq 10\%$  and  $\leq 15\%$ ) and ENplus standards ( $\leq 10\%$ ) of the average pellet characteristics. In the literary sources, moisture content is in the range (7-12%), which is not the case in all examined pellets. In Table 5 there is a variation in the form of a slight lower moisture content of 7% in the sample under number 3, and in Table 6 for samples under number 2 and 3.

Ash content in examined biomass pellets from Tables 5 and 6 is within limited range of DIN standard ( $< 1.5\%$ ), ENplus standard ( $\leq 0.7\%$ ,  $\leq 1.5\%$ ,  $\leq 3\%$ ), as well as literature sources (0.4-1.5%). Ash content of all examined samples is in the limited range of EN 14691-1 standard ( $0.5 \leq \text{od} \leq 10$  i  $> 10\%$ ).

Calorific values of the samples from Tables 5 and 6 are not within permitted interval of DIN standard (17.5 to 19.5 MJ / kg), but are within the permitted interval of ENplus standard ( $\geq 16.0$  MJ / kg). According to literature sources (16.92 to 17.64 MJ / kg), within allowed limits, are only the sample from Table 5 under number 3 and the sample from Table 6 under numbered 1. Calorific values of EN 14961-1 are not defined, but represent a minimum value that is necessary to identify, as the net calorific value according to EN 14918.

Moisture content is a major drawback for most biomass samples, such as straw, when not dried enough it may have moist content up to 30%. In such cases the material (wheat straw) must be redried so it could be used in the production process. Additional drying of materials requires increased energy consumption, the extension of the production process of biomass energy pellets and higher costs of the production.

Ash content of biomass, according to literature sources, is in the range of 0.40 to 8%. Lower ash content is in wood sawdust, the largest is in strawstalks. Based on the above mentioned it can be concluded that the ash content of energy wood pellets is within the allowed limits, while in the agriculture biomass there are significant deviations, because the crops depend on a number of factors (location, agricultural practices, material, etc..) and as such can vary within the same species. For example, an increase in ash content may occur if dust or soil enter during collection of biomass.

Calorific value of biomass energy pellets is certainly one of the most important data to make decisions about the use-value of pellets as a biofuel. There is a strong dependence of heat value on moisture content of biofuels, because with the increase in the moisture content of biomass energy pellets there is a reduction in calorific value of the same, and vice versa.

Thus, the value of heat energy pellets from biomass are valid only for specified moisture content of the pellets. It should be noted that in pellets produced from agricultural biomass heating value is reduced because of the increased moist and ash content, compared to pellets produced from wood biomass.

Examinations of the chemical elements i.e. sulfur, nitrogen, chlorine, arsenic, cadmium, chromium, copper, mercury lead, zinc and extracted organic particles are not the subject of this research. However, it is worth mentioning that they belong to the chemical and thermal indicators of quality as well as the previously mentioned parameters (moisture content, ash content and calorific value).

## CONCLUSION

Energy pellets are the most appropriate form of biomass used for energy purposes, as manipulation of them is quite simple. Due to the high consumption and the need for energy resources, pellets have an important place as an alternative energy source. Therefore, it is necessary to develop technologies that make the process of pelleting simpler, more efficient, cheaper and more accessible.

In addition to the above mentioned, for successful implementation of biomass energy pellets quality indicators must not be left out, as they aim to increase the use of biofuels so that the seller and the consumer can uniformly define the quality of biofuels from biomass origin to the sale of the final product and to ensure adequate confidence that the specific requirements for quality are met by current European standards.

Based on study results a series of data are collected which estimate chemical and thermal properties of biomass energy pellets according to current standards and existing literature. Comparing the results with existing standards and literature we come to the conclusion that the moisture and ash content significantly affects the heating value of biomass energy pellets, and with decreasing moisture and ash content in energy pellets leads to an increase of the calorific value, and vice versa. Ash content of energy pellets from crop biomass depends on many factors: location, agricultural practices, materials and such. It is necessary to take into account that when collecting the biomass it is important not collected soil, dust and other impurities, which leads to an increase in ash content of energy pellets.

The pellets produced from agricultural biomass, due to higher moisture and ash content, have lower calorific value of pellets produced from wood biomass.

## Acknowledgements

This paper is part of the research project MNTR no. III-42011 funded by the Ministry of Education, Science and Technological Development of Republic of Serbia.

## REFERENCES

- [1] Brkić M., GluvakovZorica, Janić T. (2011). Analysis of the production process of biomass energy pellets. *Contemporary agricultural engineering*, 37:2, 203-212,
- [2] GluvakovZorica, Brkić M., Janić T., (2012). Methods for determining the quality of the biomass energy pellets. *Contemporary agricultural engineering*, 38:2, 121-130,
- [3] GluvakovZorica (2012): Methods for examinations the quality of the biomass energy pellets, Master work, Agricultural faculty, Novi Sad, s. 96.
- [4] Obenberger I., Thek G. (2009). Herstellung und energetischeNutzung von pellets, InstitutfürProzesstechniktechnischeUnirversität Graz, s. 360,
- [5] Urbanovičová Olga (2011). Hodnoteni est technologický chparametrov výroby tuhých biopalin na báze biomasy, Dizertačná práca, Nitra

## BIOMASS AND SUSTAINABLE DEVELOPMENT

Srđan Vasković, Vlado Medaković, Davorin Đurović

<sup>1</sup>University of East Sarajevo, Faculty of Mechanical Engineering, East Sarajevo  
e-mail: [srdjan\\_vaskovic@yahoo.com](mailto:srdjan_vaskovic@yahoo.com), [vlado.medakovic@gmail.com](mailto:vlado.medakovic@gmail.com)

**Abstract:** In this paper will be discussed about biomass as a good resource for producing different ways of useful energy. Because, biomass is very specific for use for energy production and need more technology for processing in useful form. All conversion biomass to useful energy described with efficiency factor in energy chain, from the biomass resource to the produced energy. Supplying with energy from biomass includes many processes starting with growing high energy plants, preparing the remains of the production, collecting and storage organic waste until the final use and the conversion of biomass energy in the heat or electricity.

In BiH there are many possibilities for both growing and using forest for energy producing. Successful examples taken from forestry management practice in EU countries can be useful for enterprises, owners, commerce and environment in Bosnia.

- Correct tree growing, cutting, transporting, processing and energy distribution are important for developing of good practice in energy production from biomass.
- Alternative Energy is opportunity to influence both environment and profit. Responsible planning and social welfare can be advantage in present and future free market.

Factor EROI is most important factor for decision what is best way for using energy biomass production.

**Key words:** biomass, forestry management, briquette, pellet, possibilities

### INTRODUCTION

Any organic matter which is available on a renewable or recurring basis, including agricultural crops and trees, wood and wood residues, plants (including aquatic plants), grasses, animal residues, municipal residues.

Biomass is produced from water and CO<sub>2</sub> by photosynthesis, solar energy accumulated in construction of plants as a chemical energy[1]. In this paper is considered wood biomass, but only remains and residues from different wood processing.

Forest wood residues content:

1. Forest residue
2. Mill waste
3. Urban wood waste.

### Forest residues

The primary forestry residues include: logging residues from conventional harvest operations, forest management and land cleaning (Fig. 1).



**Figure 1.** Forest residues

### Mill waste

Mill waste is secondary forestry residues and it can be:

- Mill wastes
- Pulping liquors (Fig. 2).



**Figure 2.** Mill waste and after processing use as wood chips

### Urban wood waste

Urban wood waste is actually tertiary forest residues which can be made:

- during construction and demolition debris,
- like unusable pallets or
- tree trimmings from the urban environment (Fig. 3.)



**Figure 3.** Urban wood waste

Unfortunately, even there are possibilities for good forestry management and energy producing from wood or wood residues, those possibilities is not realized yet and it is good opportunity for use for bioenergy carriers like as chips, briquettes and pellets.

Main reason is the fact that there is plenty of forest in Bosnia. Forests like resource aren't in short supply. Also, both government and market still do not recognizing opportunity for this type of energy producing and creating new enterprises.

For growing of wood that can be used in energy producing process we can distinguish some benefits and disadvantages[2].

Disadvantages:

- Bio energy activity requires very deep knowledge of wide sector competence,
- High level of mechanization,
- Water, soil, climatic, environmental constraints limiting the biomass productivity and the type of plants,
- Need to adopt horizontal and vertical integration of sub-systems to improve the economic basis of bioenergy complexes.

Benefits:

- Marginal land recovery,
- Protecting the land (improve soil quality),
- Erosion control,
- Less fertilizer, pesticide, herbicide, and fungicide than annual row crops to purify polluted soils (phytoremediation),
- Sequestration of CO<sub>2</sub>,
- Income benefits for farmers,
- Positive effects on local employment in rural areas for the biomass resource production.

### **BIOMASS IN ENERGY PURPOSES**

The term 'biomass' describes the biomass of organic matter (it means that containing carbon). According to this, biomass includes:

- Phytoplankton and zoo-plankton (plant and animal),
- Remains of the production, production waste (egg animal excrement or straw),
- Dead (but no fossil) phytoplankton and zoo-plankton,
- All substances with organic origin that are results of technical conversion, for example black fluid, paper and cellulose, waste from slaughterhouse, organic waste from households, vegetable oil, alcohol etc).

In order to distinguish biomass and fossil fuel, there is a remark that peat, product of secondary decomposition, will not be considered like biomass in this paper, even in some countries (Sweden, Finland) it isn't so.

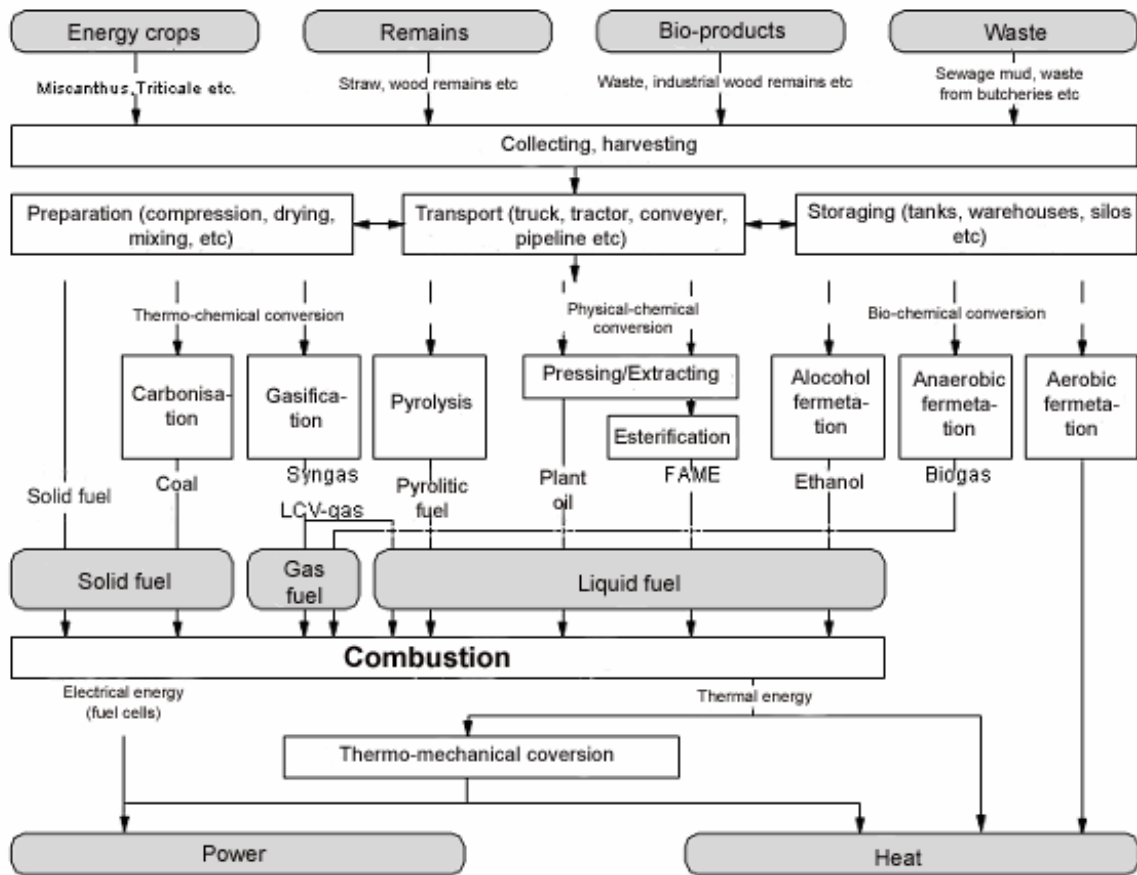
Biomass can be divided to primary and secondary products:

- Primary products of biomass appear directly under effects of solar energy during photosynthesis process and include phytoplankton, agricultural and forest products, some species that are cultivated for energy purpose (fast growing trees or grass), the plant remains, waste from agriculture and forestry (waste and remains from processing of wood, straw).
- Secondary biomass products, unlike to primary, indirectly receive energy from the sun; they are result of decomposition or conversation organic substances in the metabolism of higher organisms (egg animals). This includes, for example, all the zooplankton, animal excrements (egg solid waste, fluid waste and sludge).

### **THE STRUCTURE OF TYPICAL CHAIN FOR BIOMASS SUPPLYING**

Supplying with energy from biomass includes many processes starting with growing high energy plants, preparing the remains of the production, collecting and storage organic waste until the final use and the conversion of biomass energy in the heat or electricity[2].

The chain includes the life cycle of organic matter from its creation (i.e. primary energy) to the preparation- and obtaining useful energy. (Fig. 4).



**Figure 4.** Availability of energy from biomass (gray shadow fields - different carriers of energy, fields without shadow - conversion processes; FAME - fat acid methyl esters, reaction that occurs in fuel cells considered as "cold combustion")

The aim of this biomass supply chain is to meet possible changeable requirements for finally usable energy and providing of necessary installations for conversion. Those installations or even plants must be appropriate for particular size and/or quality of biomass. Each supply chain consists of the life cycle of biomass production, supply, conversion, practical use and disposal. Generally, all previously listed parts are divided into groups in a number of individual processes. For example, derivation of biomass requires, among other things, the preparation of land, fertilizer application and protection. After that, various processes that are conducted in entire life cycle does not occur in the same place, because the necessary transport biomass to the appropriate place (for example: trucks, tractors, pipelines).

Finally, certain supply chain is determined by the framework of conditions, which depend on the production of biomass (supply side) in one hand and the final energy supply (demand side) on the other hand. Further decisive factors are economic, technical and administrative, which have a significant impact to give a practical function to whole supply chain. For example, choosing the appropriate transformation of energy from one form to another depends on the need for some of these forms (heat or electric) in accordance with the legislation regarding to environmental protection.

Furthermore, supply structure is determined by the available (Storage) using and wasted matter during the process (such as the remains which occur in the processes of fermentation after the production of biogas or ashes that remain after combustion of solid fuels).

There are various possibilities of treating remains of production and the criteria could be characteristics of various types of biomass (such as the shape, size and moisture content) and

requirements for the application of appropriate technology for energy production, which must be defined before the conversion and providing of energy start.

Remains of biomass (which are previous sorted) can be secondary energy carriers such as: wood pellet, chips, straw bale, etc. More that that, type of biomass (wood or plant biomass), its quality (water content, composition), seasonal differences that are present in different types are effecting on the variability of energy consumption and distribution.

Those specified characteristic of biomass require different ways of storage, and the drying of biomass is an insurance that biomass will be correctly and safety storage in the warehouse. Beside that, certain economic needs must be feasible within the prescriptive conditions and socially acceptable. (Picture 4)

### DEFINITION OF EROEI FACTOR

Energy returned on energy invested (EROEI or ERoEI); or energy return on investment(EROI), is the ratio of the amount of usable energy acquired from a particular energy resource to the amount of energy expended to obtain that energy resource [4], [5] . When the EROEI of a resource is less than or equal to one, that energy source becomes an "energy sink", and can no longer be used as a primary source of energy.

$$\text{EROEI} = \text{USABLE ACQUIRED ENREGY} / \text{EXPENDED ENERGY}$$

Although many qualities of an energy source matter (for example oil is energy-dense and transportable, while wind is variable), when the EROEI of the main sources of energy for an economy fall energy becomes more difficult to obtain and its value rises relative to other resources and goods. Therefore the EROEI gains importance when comparing different energy alternatives. Since expenditure of energy to obtain energy requires productive effort, as the EROEI falls an increasing proportion of the economy has to be devoted to obtaining the same amount of net energy. On the figure 5. we have different EROEI factors for some kinds of renewable energy also for production. There are widely spread this number from 1,6 to 100. EROEI number about 1,6 describes process for production biodiesel. On the opposite site we have number for EROEI 100, which describes hydroenergy production.

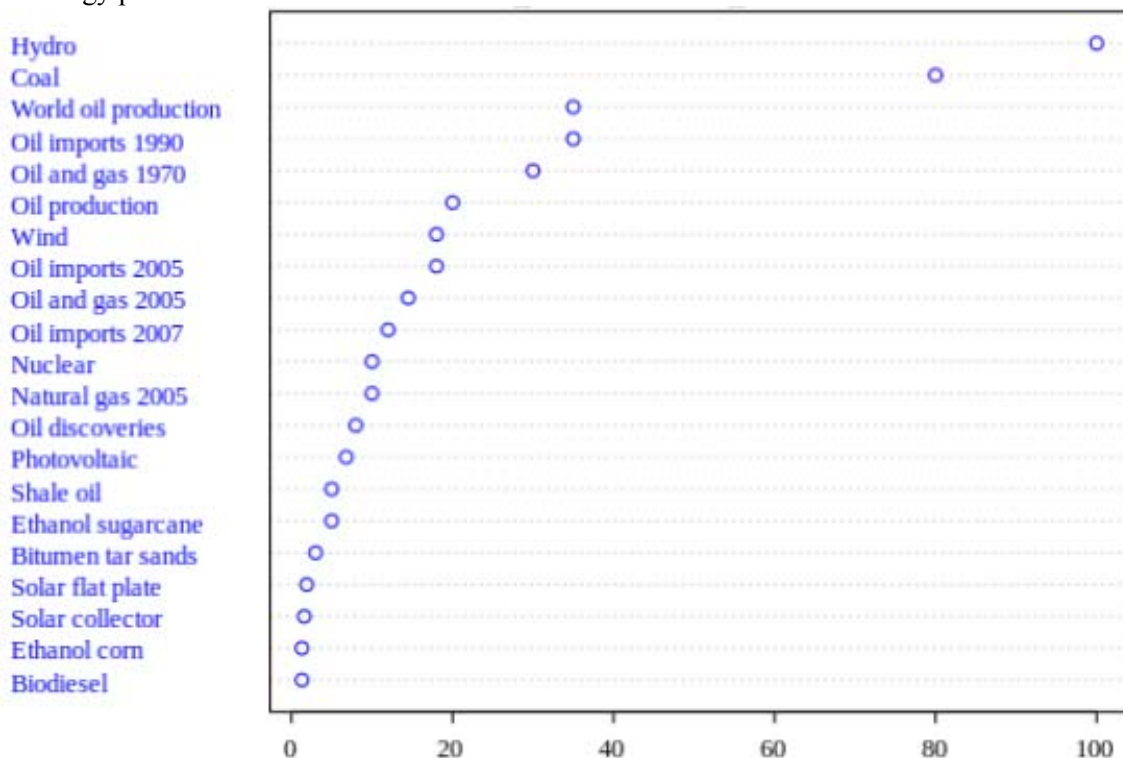


Figure 5. EROI – USA, Ratio of Energy Returned on Energy Invested for different kinds of renewable energy[4]



## CONCLUSION

On the figure 5. clearly we see no well-defined value EROEI factor biomass. The question is why? Answer is very simple. Biomass is a very demanding as energy resource from different parameters and needs a revamp. This process requires: cutting hauling, drying, transport, processing into fuel transformation. Every part of this process requires a certain amount of energy investment. To get the full picture of the state of energy production from biomass must all be considered. Accordingly the number of parameters and actions that must be determine. It is huge job but, when we will develop a good model than we have good situation for analyzing best way solution for biomass energy production.

## REFERENCES

- [1] Twidell, J., Weir, T., Renewable Energy Resources, London and New York, 2006.
- [2] Todorović, M., Harmony and Ethics of Sustainability.
- [3] Bassano, C., Renewable Sources and Innovative Energetic Cycles.
- [4] Murphy, D.J., Hall, C.A.S. (2010), Year in review EROI or energy return on (energy) invested, Annals of the New York Academy of Sciences 1185: 102–118. Page.
- [5] Cutler, Cleveland (2011-08-30), "Energy return on investment (EROI)", The Encyclopedia of Earth, 2011.
- [6] Vasković, S., Gvero, P., Medaković, V., Milić, D., THE IMPORTANCE OF ANALYSIS ENERGY CHAINS BASED ON BIOMASS FOR ENERGY PRODUCTION, 1st INTERNATIONAL SCIENTIFIC CONFERENCE "Conference on Mechanical Engineering Technologies and Applications" COMETA 2012, str. 465. – 470., ISBN 978-99938-655-5-1, East Sarajevo - Jahorina 2012.
- [7] Husika, A., Vasković, S., Medaković, V., Proizvodnja i korištenje drvnog čipsa za proizvodnju toplotne energije, str. 116. – 122., 2<sup>nd</sup> B&H Energy Council with International Participation Energy Efficiency & Renewable Energy Sources Proceedings, Neum 2009.

## **SESSION 9: Reengineering and Project Management**

## LINGUISTIC PROJECT MANAGER SELECTION

Ali Reza Afshari<sup>1</sup>, Ahmad Baghi<sup>2</sup>

<sup>1</sup>Department of Industrial Engineering, Islamic Azad University, Shirvan Branch, Shirvan, Iran

<sup>2</sup>Department of Marketing, Islamic Azad University, Shirvan Branch, Shirvan, Iran  
e-mail: afshari\_2000@yahoo.com

**Abstract:** Nowadays project based organization success hinges upon many different factors; one of those factors is qualified project manager selection. Regarding to this fact that selecting qualified project managers is among those complex issues, this process of selection requests for having analytical methods to handle those kinds of issues. However, there are varieties of different methods in the literature. Developing a model based on linguistic variables due to assessing the candidate ratings in one hand, and determining criteria importance in the other hand is the main objective of this paper. The evaluation process is based on new group fuzzy linguistic modeling and fuzzy aggregating. By using fuzzy linguistic variables with multi criteria decision making (MCDM), a new project manager selection model is offered in this paper.

**Key words:** Personnel selection, Linguistic variables, Project Manager

### INTRODUCTION

Experimental and statistical techniques are the most famous approaches that are implemented by traditional personnel selection procedure. In the first approach (experimental) selection of qualified persons is done based on the experiences and knowledge of decision makers. While, in second approach (statistical), decisions are made after interpretation of test scores and also measurement of accomplishment for each candidate. As Robertson and Smith [1] proposed, one of the well-known techniques concerning the personnel selection is interview. There are myriad of ability and availability of interviews for anticipating the performance of the personnel in the job. Considering a number of studies that are based on techniques such as interviews, work sample tests, assessment centers, resumes, job knowledge tests, and personality tests in human resource management [2], just a few of them have implemented the multi criteria (MCDM) techniques in their studies [3].

MCDM deals with decision problems with a number of decision criteria and it is a branch of operations research models and divided into multi attribute decision making (MADM) and multi objective decision making (MODM). Each of the above categories consists of several methods. Each method can also be classified as deterministic, stochastic and fuzzy methods with its own characteristics. Sometimes researchers may use a combination of the methods. The methods can be classified as a single or group decision making methods based on the number of decision makers [3]. Some of the contributors applied AHP [4-7], ANP [8, 9], TOPSIS [10, 11] and Expert Systems [2, 12-17] in personnel selection.

Fuzziness is the main attribute of personnel selection issue. The fuzzy linguistic approach represents qualitative aspects as linguistic values by means of linguistic variables [18, 19]; while, regular crisp set method does not follow the same rule. Since linguistic reasoning needs fewer assessments information, it needs few postulations to be fulfilled. Moreover, regarding to the importance of this tool, it is considered as a realistic tool for decision makers [21]. Hence, linguistic MCDM is employed in step two.

Many researchers have used MCDM in selecting project manager. For example, a fuzzy MCDM method for information system project manager selection was developed by Chen and Cheng [20]. Bi and Zhang [21] analyzed the meaning of selecting an eligible undertaking manager in their study. They endeavored to quantitatively assess the skill and quality of undertaking manager by requesting fuzzy analytical hierarchy process that was established on triangular fuzzy numbers. Whatever they did is believed as a reliable and logical method in words of selecting the right person for undertaking manager. Hui et al. [22] endeavored to clarify a suitable competency established framework. The rationality of this paper is examined in methodology section which was constructed principle component analysis. This study has been made prominently priceless and referential in project

manager selection by all these efforts. Liqin et al. [23] has established an extensive assessment model of project manager candidates by implementing principles of fuzzy mathematics. Based on grey criteria, a multi criteria methodology for project manager selection has been bolster by Zavadskas et al., [24]. In the selection of a project manager a fuzzy comprehensive evaluation methods has been adopted by Zhao et al. [25]. Rashidi et al. [26] for choosing a qualified project manager, amalgamated fuzzy systems, ANNs, and Genetic algorithm.

Mitigating the errors in utility values is the result of enhancing the efficiency of decision making that can be achieved by conducting the fuzzy linguistic variables. The main goal of this study is to bolster and establish a group multi criteria decision making (GMCDM) model based on fuzzy set theory in order to candidate assessment in project manager selection.

## MATERIAL AND METHODS

Model inputs, processes and output (selection of personnel) are systematically outlined in this section. Elements of accomplished algorithm have been drawn in Fig. 1.

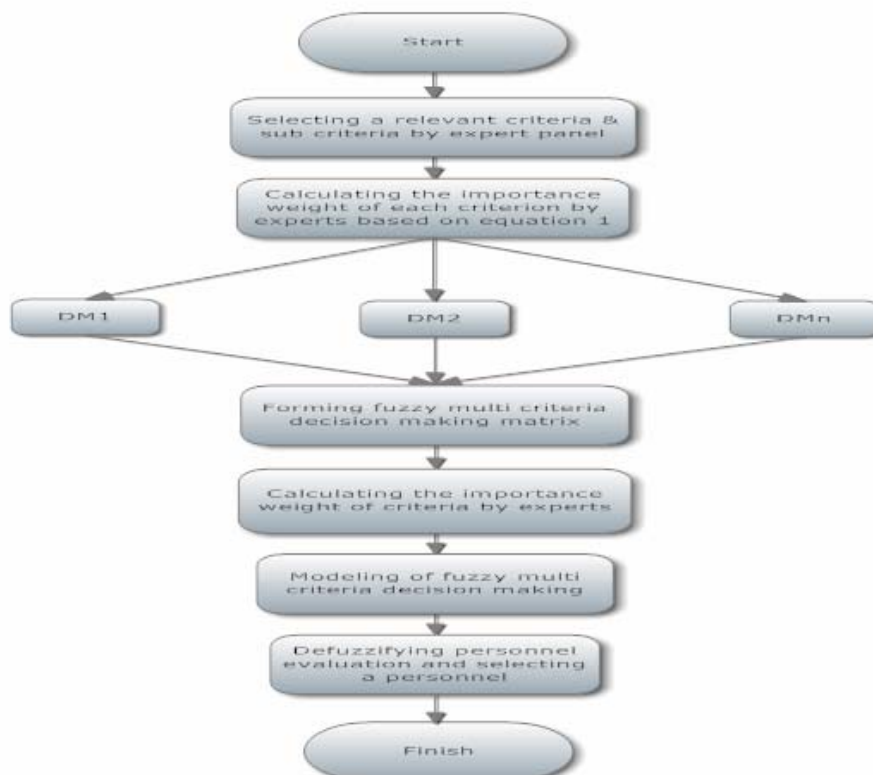


Figure 1. Modeling Processes

In following paragraphs, different phases are elucidated based on the algorithm of modeling process in terms of personnel selection.

1) Selecting relevant criteria and sub criteria: The criteria and sub criteria are formed for personnel selection based on expert panel opinions and data and information of an organization. Those who have significant information about human resources in one side and strategic direction of an organization in the other side are selected as the members of experts' panel. Delphi or Nominal Group Technique (NGT) are among the several methods that can be implemented for identifying personnel based upon the opinions of experts.

2) Calculating the importance weight of criteria: In two continuous operations the importance weight of criteria is calculated. In first step, the importance weights of sub-criteria are calculated based on the experts' opinions. Afterward, regarding to the equation 1 the importance weights of criteria are computed.

3) Establishing criteria and forming decision making matrix the importance weight of criteria: The criteria and sub criteria for personnel selection are determined by NGT method throughout the expert panel. An expert panel was selected by a team of experts. Then these experts were asked to specify the project manager selection criteria respectively. All the respondents had more than five years experience in project administration with a relevant knowledge and all were among the company's management. Management had selected a panel consisting of procurement deputy, engineering deputy, executive deputy, administrative and financial deputy, planning deputy, quality and systems deputy, inspection manager, Safety manager, contracts manager, and the Human resource Department. A hierarchy is constructed in accordance with the criteria and factors.

4) Modelling of FMCDM: Modeling procedures of FMCDM are described as follows:

1. The first step to construct a FMCDM is defining universe set which is the element of universe  $U = \{1, 2, 3, 4, 5, 6, 7\}$

2. Then membership function for each criteria and alternatives is selected. A "membership function" is a curve that defines how the value of fuzzy variable is mapped to a degree of membership between 0-1. Membership functions are used to calculate the degree of FMCDM in different values expressed by linguistic term.

3. With considering bell shape membership function, the decision matrix (fuzzy sets of criteria and alternatives) is formed regarding and equation (1).

$$\mu_A(x) = \frac{1}{1 + d(x - c)^2} \quad (1)$$

Where  $x \in [0, 1]$  is the element of universe  $U = \{1, 2, 3, 4, 5, 6, 7\}$ ,  $c$  indicates the standard score for determining verbal (linguistic) value of the criteria and personnel and  $d$  determines the shape of the membership function (here  $d = 0.2$ ).

4. With applying subsequent formula, the utility of decisions (personnel) is calculated using equation (2).

$$A_i = \{(\overline{C_1} \cup ai_1) \cap (\overline{C_2} \cup ai_2) \cap \dots (\overline{C_m} \cup aim)\} \quad (2)$$

$$A_i = \bigcap_{j=1}^m (\overline{C_j} \cup aim)$$

In terms of experts' opinions, the importance weights of sub criteria are calculated. Then the importance weights of criteria are computed based on equation (1).

5) Selecting best personnel: In With employing centre of gravity method, fuzzy outputs of personnel transform to crisp utility with regards to equation 5.1 [27-30].

## RESULTS AND DISCUSSION

In order to enhance the authenticity of the linguistic model, an Iranian company, MAPNA, which is a project based organization, was used as a case study. Engaging in development and implementation of power, oil and gas, railway transportation and other industrial projects, MAPNA has 371 employees and located in Tehran. Since 1992, MAPNA has been involved in more than 85 projects with a total value of greater than 17 billion euro. Among its employees 14 persons have been able to obtain international certificate in Professional Project Management (PMP). As the process of selecting the right project managers have always been a critical consideration in MAPNA, this procedure have been done through conducting a group of experts. The group of decision makers (Expert panel) consists of decision makers from different organizational departments and high level managers. Procurement deputy, engineering deputy, executive deputy, administrative and financial deputy, planning deputy, quality and systems deputy, inspection manager, HSE manager, contracts manager, and the HR department are formed the body of the committee for appraising of candidates.

Based on Phase 3 experts have consensus for establishing criteria and forming decision making matrix with regards to Table 1 by equation 1 and NGT method. The FMCDM is illustrated in Table 1.

**Table 1.** Fuzzy multi-criteria decision matrix

Criteria Personnel	C <sub>1</sub>	C <sub>2</sub>	C <sub>3</sub>	C <sub>4</sub>
P <sub>1</sub>	VH	H	L	EL
P <sub>2</sub>	EH	M	VH	H
P <sub>3</sub>	EL	L	H	M
P <sub>4</sub>	H	M	L	EL
P <sub>5</sub>	M	EH	EL	L
P <sub>6</sub>	M	M	H	EH
P <sub>7</sub>	L	EL	H	L
P <sub>8</sub>	VL	M	L	H

Considering consensus of expert panels and taking figure 3 into consideration, phase 3 fuzzy weighting of criteria has been illustrated. The membership function of criteria weighting under fuzzy space is depicted and the fuzzy utility of each personnel is calculated by steps 4.3 and 4.4 and equations 4.1, 4.2 and 4.3. Then by employing centre of gravity method, fuzzy outputs of personnel are converted to crisp utility. Finally, with regards to previous step which determined crisp utility of personnel subsequently, the personnel are ranked as illustrated in Table 2.

**Table 2.** Personnel Ranking

No. of Personnel	Utility	Rank
P <sub>1</sub>	0.4005	5
P <sub>2</sub>	0.4607	1
P <sub>3</sub>	0.3910	6
P <sub>4</sub>	0.4563	3
P <sub>5</sub>	0.3868	8
P <sub>6</sub>	0.4567	2
P <sub>7</sub>	0.3880	7
P <sub>8</sub>	0.4562	4

## CONCLUSION

As it is mentioned earlier the main objective of this research was to contribute the concept of personnel selection. This goal was achieved by establishing an integrated group decision making and fuzzy linguistic assessment, which entirely gained through a developed decision methodology. It is unveiled that by implementing fuzzy MCDM model, which is elaborated in this research, personnel selection can be improved in so many ways. Evaluating of candidates based on the verbal terms is the first advantage of implementing fuzzy MCDM for decision makers in the process of personnel selection. Less emphasis on detailed data collection, which is achieved by applying linguistic variables, is the second privilege of implementing fuzzy MCDM.

For evaluating personnel, fuzzy linguistic had a key role in the methodology of this research. Regarding the future studies, providing another effective mechanism in making a model for decision makers' preference is highly recommended. Handling the ambiguity of the human decision making procedure can be the other potential suggestion in personnel section issues.

## REFERENCES

- [1] I. T. Robertson and M. Smith, "Personnel selection," *Journal of Occupational and Organizational Psychology*, vol. 74, pp. 441-472, 2001.
- [2] C. F. Chien and L. F. Chen, "Data mining to improve personnel selection and enhance human capital: A case study in high-technology industry," *Expert Systems with Applications*, vol. 34, pp. 280-290, 2008.
- [3] S. D. Pohekar and M. Ramachandran, "Application of multi-criteria decision making to sustainable energy planning - A review," *Renewable and Sustainable Energy Reviews*, vol. 8, pp. 365-381, 2004.
- [4] H. S. Shih, L. C. Huang, and H. J. Shyr, "Recruitment and selection processes through an effective GDSS," *Computers and Mathematics with Applications*, vol. 50, pp. 1543-1558, 2005.
- [5] M. Tavana, D. T. Kennedy, and P. Joglekar, "A group decision support framework for consensus ranking of technical manager candidates," *Omega*, vol. 24, pp. 523-538, 1996.
- [6] F. A. Taylor, A. F. Ketcham, and D. Hoffman, "Personnel evaluation with AHP," *Management Decision*, vol. 36, pp. 679-685, 1998.
- [7] R. Gibney and J. Shang, "Decision making in academia: A case of the dean selection process," *Mathematical and Computer Modelling*, vol. 46, pp. 1030-1040, 2007.
- [8] S. K. Liao and K. L. Chang, "Selecting public relations personnel of hospitals by analytic network process," *Journal of Hospital Marketing and Public Relations*, vol. 19, pp. 52-63, 2009.
- [9] S. K. Liao and K. L. Chang, "Select televised sportscasters for Olympic games by analytic network process," *Management Decision*, vol. 47, pp. 14-23, 2009.
- [10] C. H. Yeh, "The Selection of Multiattribute Decision Making Methods for Scholarship Student Selection," *International Journal of Selection and Assessment*, vol. 11, pp. 289-296, 2003.
- [11] H. S. Shih, H. J. Shyr, and E. S. Lee, "An extension of TOPSIS for group decision making," *Mathematical and Computer Modelling*, vol. 45, pp. 801-813, 2007.
- [12] E. H. Suh, D. H. Byun, and Y. S. An, "An approach to effective job placement in an organization: A case study," *Human Systems Management*, vol. 12, pp. 129-143, 1993.
- [13] R. S. Hooper, T. P. Galvin, R. A. Kilmer, and J. Liebowitz, "Use of an expert system in a personnel selection process," *Expert Systems with Applications*, vol. 14, pp. 425-432, 1998.
- [14] V. Cho and E. W. T. Ngai, "Data mining for selection of insurance sales agents," *Expert Systems*, vol. 20, pp. 123-132, 2003.
- [15] A. Jessop, "Minimally biased weight determination in personnel selection," *European Journal of Operational Research*, vol. 153, pp. 433-444, 2004.
- [16] E. Jereb, U. Rajkovic, and V. Rajkovic, "A hierarchical multi-attribute system approach to personnel selection," *International Journal of Selection and Assessment*, vol. 13, pp. 198-205, 2005.
- [17] M. Saidi Mehrabad and M. Fathian Brojeny, "The development of an expert system for effective selection and appointment of the jobs applicants in human resource management," *Computers and Industrial Engineering*, vol. 53, pp. 306-312, 2007.
- [18] E. Herrera-Viedma and E. Peis, "Evaluating the informative quality of documents in SGML format from judgements by means of fuzzy linguistic techniques based on computing with words," *Information Processing & Management*, vol. 39, pp. 233-249, 2003.
- [19] L. A. Zadeh, "The concept of a linguistic variable and its application to approximate reasoning-I," *Information Sciences*, vol. 8, pp. 199-249, 1975.
- [20] L. S. Chen and C. H. Cheng, "Selecting IS personnel use fuzzy GDSS based on metric distance method," *European Journal of Operational Research*, vol. 160, pp. 803-820, 2005.
- [21] X. Bi and A. D. Zhang, "Application of fuzzy analytical hierarchy process in selecting a project manager," in *Proceedings of 2006 International Conference on Management Science and Engineering, ICMSE'06 (13th)*, 2007, pp. 1417-1421.
- [22] Z. Hui, W. Xue-Qing, Y. Gang, and Z. Li-Fu, "Study on Engineering Project Manager Selection," 2008, pp. 1-4.
- [23] Z. Liqin, G. Yuexian, and C. Wenming, "The Application of Fuzzy Comprehensive Evaluation Methods in the Selection of a Project Manager," 2009, pp. 1387-1391.

- [24] E. K. Zavadskas, Z. Turskis, J. Tamošaitiene, and V. Marina, "Multicriteria selection of project managers by applying grey criteria," *Technological and Economic Development of Economy*, vol. 14, pp. 462-477, 2008.
- [25] L. Zhao, Y. Guo, and W. Cui, "The Application of Fuzzy Comprehensive Evaluation Methods in the Selection of a Project Manager," in *Computer Sciences and Convergence Information Technology, 2009. ICCIT '09. Fourth International Conference on*, 2009, pp. 1387-1391.
- [26] S. Abbas Rashidi, F. Jazebi, and I. Brilakis, "Neurofuzzy Genetic System for Selection of Construction Project Managers," *Journal of Construction Engineering and Management*, vol. 137, p. 17, 2011.
- [27] J. Dodangeh "Master Thesis: Modeling of Fuzzy Balanced Scorecard," in *Department of Industrial Management*. vol. Master of Science Tehran: I.A.U, Science & Research Branch, 2006, p. 130.
- [28] J. Dodangeh , R. B. M. Yusuff, and J. Jassbi, "Using Topsis Method with Goal Programming for Best selection of Strategic Plans in BSC Model," *Journal of American Science*, vol. 6, pp. 136-142, 2010.
- [29] J. Dodangeh, M. Mojahed, and V. Nasehifar, "Ranking of Strategic Plans in Balanced Scorecard by Using Electre Method," *International Journal of Innovation, Management and Technology*, vol. 1, pp. 269-274, 2010.
- [30] J. Dodangeh, J. Jassbi, M. Mousakhani, M. Anisseh, and R. Bt. Mohd. Yusuff, "Priority of strategic plans in BSC model by using of Group Decision Making Model," in *2008 IEEE International Conference on Industrial Engineering and Engineering Management, IEEM 2008*, 2008, pp. 471-475.



## THE USE OF STATISTICAL METHODS TO ANALYSIS EXPORTS OF LIBYAN IRON AND STEEL COMPANY

**Ramadan Ahmed Abugeddida**

University of Misurata, Engineering Faculty, Misurata, Libya

e-mail: [Lemdolli@yahoo.com](mailto:Lemdolli@yahoo.com)

**Abstract:** There are common statistical methods which use to continue improvement such as control charts, histograms, scatter plots, sampling methods, inspection plans. These methods pioneered 70 years ago by Walter Shewhart and later promoted and enhanced by W. E. Deming, A. Wald, and K. Ishikawa, were targeted at an environment where measurements were taken manually and recorded on paper spreadsheets, and where calculations were done with slide rules. The production of these charts continues today as a result of customer mandates enforced by audits, but they play almost no role in problem solving, even where statistical methods are needed. [1]. In this paper was used some of statistical tools known in the analysis of exports in the Libyan Iron and Steel company, in order to reach an overview about the general trend of exports and determine the relative importance of each of them. In addition to knowledge of the relationship between those exports, and these analyzes we can get significant results help decision makers to focus on the strengths and weaknesses related to exports.

**Keywords:** Statistical methods, Exports, Iron and Steel, Analyzing

### INTRODUCTION

The Iron and steel industry is one of the industries that need large capital expenditure compared to other industries, most countries resorting to support such industries because they are strategic industries are essential for any country. Most countries establish factories for iron and steel to meet local needs and the rest is exported.

The Libyan Iron and Steel seeking since its creation to bring about a balance between domestic sales and exports for several reasons including: meet the needs of the domestic market of iron and steel products and then export the surplus in order to obtain foreign currency, which is used to buy iron ore and production requirements different.

### OBJECTIVES OF PAPER

This paper aims to analyze the exports during the period from 2000 until 2010 by using some of statistical methods which used for continuous improvement. And to know the strengths and weaknesses of the company with regard to exports.

### TOOLS AND TECHNIQUES FOR ANALYSIS AND IMPROVEMENT

#### **Pareto analysis**

If the symptoms or causes of defective output or some other 'effect' are identified and recorded, it will be possible to determine what percentage can be attributed to any cause, and the probable result will be that the bulk (typically 80 per cent) of the errors, waste, or 'effects', derive from a few of the causes (typically 20 per cent)[1].

#### **Scatter diagram**

This tool using to measure possible relationship or correlation between two factors or variables.

#### **Application:**

- Provide data to confirm a hypothesis that two variables are related.
- Evaluate the strength of a potential relationship.
- Follow-up to cause-and-effect analysis.

**Type of relationship:**

- No correlation.
- Positive correlation.
- Negative correlation.
- Curvilinear correlation.

**Steps to Draw a Scatter Diagram**

- Collect the data.
- Draw the axes of the diagram.

**Run Chart**

Run chart is used to understand the trends and shifts in a process or variation over time, or to identify decline or improvement in a process over time. In a run chart, events, shown on the y-axis, are graphed against a time period on the x-axis. For example, a run chart in a restaurant might plot the number of customers served against the time of day or day of the week. The results might show that there are more customers at noon than at 3 p.m. and more during weekend than during weekday. Investigating this phenomenon could unearth potential for improvement as to how many waiters and waitresses should be employed during those time for better customer service.

**A case study: Libyan Iron & Steel Company (LISCO)**

The Company is one of the largest companies in the **Libya** with an annual designed capacity of 1,324,000 ton of liquid steel . The company is situated near the coastal city of Misurata , about 210km east of Tripoli on an area of 1,200 hectares .

The company comprises of the following production facilities and supporting facilities :

- 1) Direct Reduction Plant .
- 2) Steel Melt Shop No. 1 .
- 3) Steel Melt Shop No. 2 .
- 4) Bar and Rod Mills .
- 5) Light and Medium Section Mill .
- 6) Hot Strip Mill .
- 7) Cold Rolling Mill .
- 8) Galvanizing Line .
- 9) Continuous Coating Line .
- 10) Port & Pellet stock yard .
- 11) Power & Desalination plant .
- 12) Oxygen & Compressed air plant .
- 13) Sedada Quarry & Calcimine plant .
- 14) Training Center .
- 15) Quality Control Laboratories .

The company is committed to satisfying customer requirements and establishing itself as one of the major producers of iron and steel in the world by emphasizing quality as one of its paramount goals . It has established quality council that aims at implementing the requirements of the international quality system ( **ISO** ) in all production facilities as one of its major goals .

Thus, The Libyan Iron and Steel Company has acquired the 12th European Award of quality for the year 1998, and it has been rewarded the International Quality Certificate( **ISO** 9001/2000 ) on 25/3/2002 . [2]

**Exports**

LISCO's products have in the last decade met most of domestic requirements for rolled steel. LISCO's products have also found their way into foreign markets world wide in the following main regions :

- 1) African and middle-east countries such as Egypt, Tunis, Morocco, Jordan, Qatar, etc.
- 2) European countries such as Italy, Spain, France, Greece, Turkey, etc .
- 3) South east Asian countries .

The yearly quantities sold by LISCO in the last ten years in international markets are as shown in the table1, as shown in Fig. 1.

**Table 1.** The yearly quantities in the last ten years in international markets [2].

<b>year</b>	<b>HBI</b>	<b>DRI</b>	<b>Bars &amp; Rods</b>	<b>Sections</b>
2000	375,798	-	161,520	12,006
2001	325,933	-	150,815	11,306
2002	369,711	-	119,854	9,985
2003	339,434	-	71,804	10,428
2004	476,675	-	19,935	20,437
2005	427,785	-	-	10,542
2006	384,435	86,117	-	25,301
2007	426,210	139,510	-	35,619
2008	279,654	47,748	-	8,009
2009	161,474	96,913	-	11,135
2010	479,816	92,384	-	-
2000	174,440	6,593	4,981	5,695
2001	270,744	18,857	2,569	2,177
2002	350,395	4,704	-	1,848
2003	286,048	1,294	1,706	7,387
2004	257,123	2,570	271	2,778
2005	337,464	-	124	772
2006	438,831	1,214	-	-
2007	377,566	605	-	757
2008	319,858	2,099	4,415	1,380
2009	190,096	2,843	6,817	2,840
2010	1,148	2,099	-	-

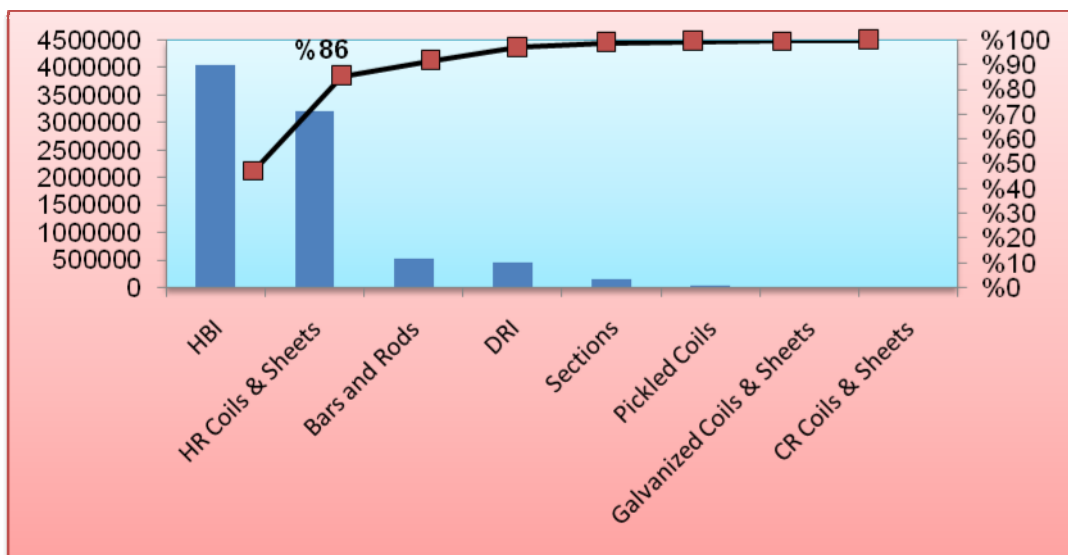


**Figure 1.** The yearly quantities in the last ten years in international markets

This figure shows that the company's exports began to rise until it reached the highest value in the year 2007, and then began to decline until it reached its lowest value during the year 2009, which coincided with the global financial crisis and then began to rise again in 2010 after the global economic recovery. also be attributed to significant decline in exports due to the company stopped exporting rebar, and this is due to the Libyan government to take the decision to stop exporting steel because the domestic market need to these quantities.

Pareto Analysis for Exports :

Pareto analysis is one of the most important tools used in the statistical analysis and draw conclusions, and I have been using this analysis in this study in order to know the most important exports, which constitute 80% of the total Exports during the study period, as shown in Fig. 2.

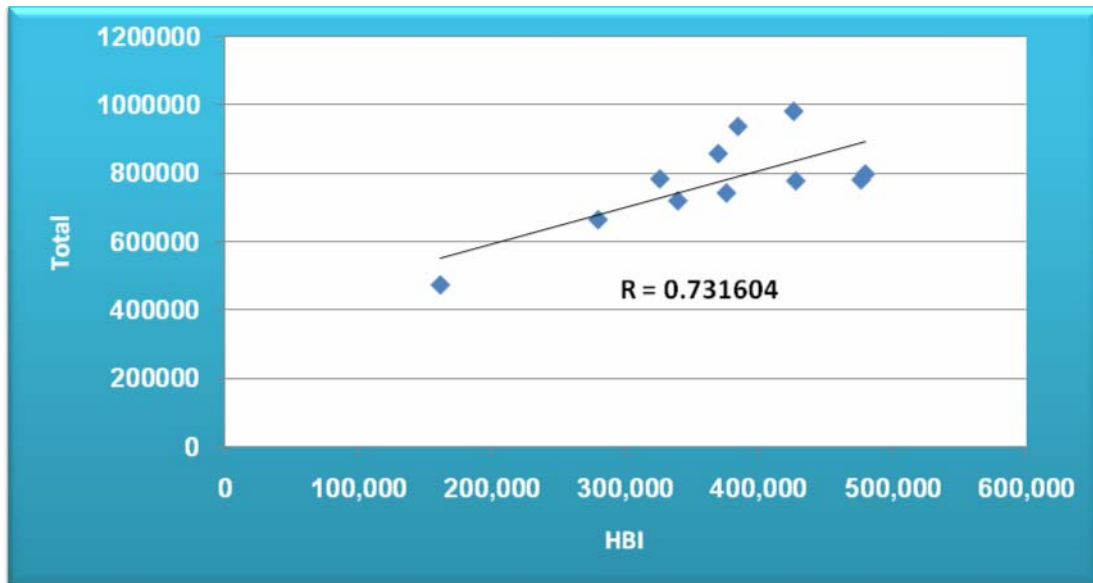


**Figure 2.** The results of Pareto analysis for Exports during the study period

According to Fig. 2 , we can note that there are two types of exports accounted for 80%, the HBI and cold rolled coils. Therefore the focus must be on these two types in the future.

### The Relationship between HBI and Total Exports

The relationship between exports of HBI and total exports can be found by finding the correlation coefficient. Fig. 3 shows the relationship between HBI and the total exports, as shown in Fig. 3.

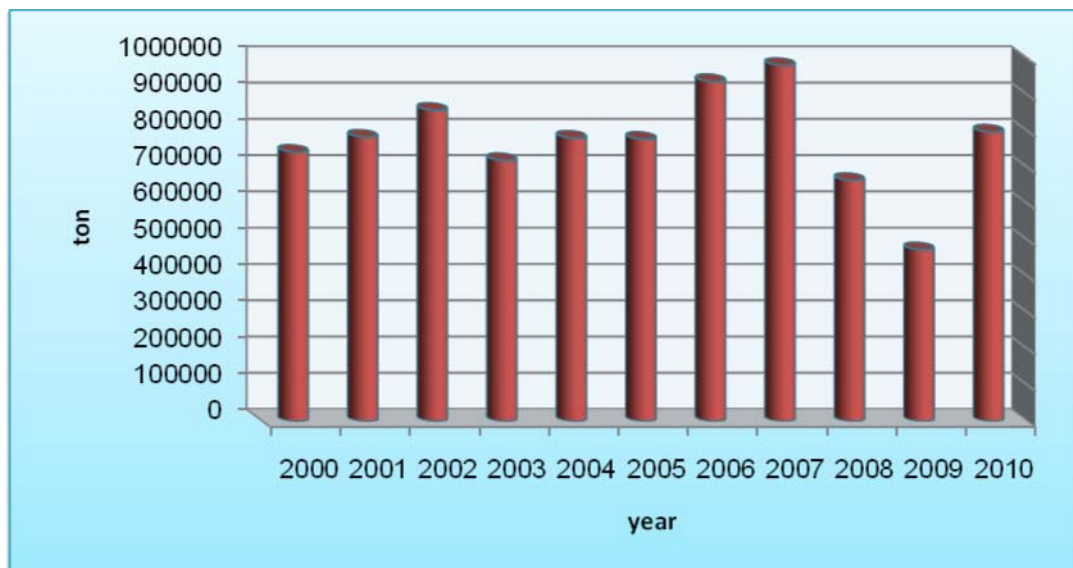


**Figure 3.** The relationship between HBI and Total Exports

From the previous Figure, it can be observed that the relationship between HBI and total exports were strong through the correlation coefficient, which is equal to 0.731. Therefore, exports of HBI a positive impact in the increase in total exports.

### The impact of the global financial crisis on the company's exports

The company's exports affected by the global financial crisis, and this is evident through lower exports during the year 2009, as shown in Fig. 4.



**Figure 4.** The company's exports during the study period

Fig. 4 shows that the global financial crisis has had a clear impact on the company's exports, as the figure indicates that the company was able to increase exports in the year 2010.

## CONCLUSIONS

The results showed that the general trend of exports is declining, and this is due to the following reasons:

- 1) The Libyan Iron and Steel Company is a government Co. its policies stem from country policies in directing the company's products to the local market as a first step and export the surplus.
- 2) Pareto analysis results showed that the highest amount of exports during the study period were products of HBI, and this shows that this product is very important for the company as well as for the global market.
- 3) The study results show that the global financial crisis contributed to reducing the amount of exports, particularly in the years 2009 and 2010.

## REFERENCES

- [1] John S. Oakland, "Total Quality Management", Butterworth Heinemann. 1993.
- [2] The Exports Annual reports of Libyan Iron and Steel Company.
- [3] [www.libyansteel.com](http://www.libyansteel.com)

## VIRTUAL ENVIRONMENT IN POLISH TOURISM ENTERPRISES: NOW AND IN THE FUTURE

Ewa Forystek-Zabojszcz, Jolanta Staszewska  
Opole University of Technology, Slovakia  
[ewafor@gmail.com](mailto:ewafor@gmail.com)

**Abstract:** The article presents IT tools used by modern tourism enterprises and it indicates, on the basis of latest technical and technological novelties, possible trends in the development of virtual tourism of the future. The first part is a presentation of the application of IT tools in various fields of activity of a tourism company, including the role of the Internet in the development of tourism services. The results of the research on the degree of utilization of the virtual environment by Polish tour operators are also presented in this section. The second part discusses the impact of technological development in the IT sector on the emergence of new tools that support the activities of tourism organizations. It also indicates possible patterns of development of e-tourism, marked by new trends in tourists' needs and behaviour.

**Key words:** IT tools, virtual environment, tourism

### INTRODUCTION

In the second half of the twentieth century, the world has entered a new economic era, when the development of IT and telecommunication techniques changed the face of mankind and led to technological, economic, social and cultural revolution. The process, by removing the barriers of time, space, and social communication, significantly affected the development of tourism industry and determined its current shape. Modern tourism enterprises function, to a large extent, thanks to the utilization of virtual environment and its tools used to support every field of their activity. The aim of this article is to present the IT tools that support the functioning of tourism enterprises at present, and to indicate possible trends in the development of digitalization of the tourism sector in the short and long term.

### MATERIAL AND METHODS

#### The utilization of IT tools in the tourism sector

The use of virtual environment enables connecting the organization with external and internal elements of the (supply, distribution, logistics) value chain of suppliers and service customers. [1] „On the microeconomic level, IT technologies are basic tools for strategic management, operational management and the competitive struggle.” [2] Thanks to the diversity of technical, technological and organizational solutions that they offer, they support the processes of business management [3] on the level of operational management and in the sphere of distribution and tourism marketing. [4] The management process is usually based on specialized accounting, HR and payroll management software, databases, and decision support systems. Communication with contractors usually takes place in the Internet, through communicators such as Skype, and GaduGadu, [5] through the transfer of business transaction information, EDI data exchange, and B2B sales, where the IT system consists of advanced tools supporting the preparation and management of tourism offers. [6] The channel for exchanging information with service customers, in turn, includes the information-marketing part, where the Internet plays a key role. It enables the functioning of a wide range of software tools such as „Expedia, Travelocity, Internet Travel, Network, Priceline,” [7] which facilitate the information flow between a tourism organization and its potential or actual clients. Recently, thanks to the development of the cellular network (GSM and WAP), mobile and wireless technologies start to assume significance. „The proliferation of different mobile devices, such as Personal Digital Assistants (PDAs) and 3G mobile phones with Global Position Systems (GPSs)” becomes a reality. [8] New generation of mobile technologies (3G and 5G) enable sending multimedia messages, localization of the customer and access to a PC. „New possibilities are opened for tourism mainly by such

technologies as MMS, GPRS or UMTS, which, along with the Internet, helps popularize the offer.” [9] „The majority of tourism enterprises use mobile technologies to contact with their passengers directly, and to inform them about the product via SMS or MMS.” [10] Marketing communication functions thanks to websites, presenting basic information about an enterprise and its offer. [11] It is also made possible thanks to websites with multimedia, such as banners, mostly in the form of graphic links, or pop-up windows, which re-direct the user to a different website. [9] Yet another form of marketing message is information transmitted via so-called e-WOMs, which are platforms for exchanging consumer opinions. [12] Such on-line communication may have various forms: from internet forums and discussion groups to social networking websites. The electronic channel of distribution of tourism services (e-commerce) consists in managing the sales by means of information technologies, [13] including specialized computer reservation systems (CRS) and global distribution systems (GDS), [14] which evolved from CRS. GDS include: SABRE, AMADEUS, GALILEO INTERNATIONAL and WORLDSPAN. Computer reservation systems not only present the offer of tourism services, but also provide information on rates, along with the calculation option, enable accepting orders for tickets, vouchers, and complementary services. They provide detailed information on the journey, e.g. rates in a given currency, customs and visa regulations. They enable making any type of reservation, hiring a car and buying tickets or entrance cards to any event and tourist attraction. What is more, they help manage the income of a tourism enterprise. [15] Systems of such a type are based on mapping the users' needs and limitations and then matching separate components so that they can return to the operators in the form of ready offer solutions. [16] Thanks to their functionality, the client can influence the shape of a tourism product, and not only make choice of one product, but also adjust it precisely to their needs (e.g. the conditions of their stay in a hotel). [17] Apart from CRS and GDS, there is also a wide range of systems that support the process of distribution of tourism services. Among them are: the Destination Management System, internet tools such as Expedia, Travelocity, Preview Travel, Internet Travel Network, Priceline, mobile devices (PDS, WAP, GPRS), and technologies that support automated systems (e.g. telephone exchanges). [7] Nowadays, the Internet is the most important medium of tourist information. It is precisely „the use of the Internet in the tourism sector as a distribution channel alternative to GDS that eliminated three most important limitations of traditional distribution channels.” [10] It reduced costs, expanded the group of target customers and enabled presentation of specific information. [10] By exploiting the Internet as a marketing tool, and thanks to resulting significant reduction of costs and increase of income, tourism organizations have raised funds for research, development, databases, and customer retention. [8] Substantial is also the role of the Internet in the sphere of tourist information exchange, which supports internal and external processes taking place in tourism organizations [12] and enabling the company to maintain constant and virtually unrestricted digital contacts with clients. [18] What is more, as far as its influence on the process of contacting with co-operators is concerned, the Internet increases the competence of individual entities, efficiency of their activities, and flexibility of responding to changing market conditions. [19] It is also creates new possibilities of increasing the overall quality of the final product by offering novel solutions. [8]

### **The analysis of the use of IT tools by tour operators from the region of Opole**

A survey was conducted in order to identify the types of IT tools used by tourism organizations. It was administered in the region of Opole, in the third quarter of 2013. This region has a high potential for the development of tourism, which is why it was chosen for the purposes of the research. The study covered the entire population of tour operators and 40% of the questionnaires were returned. The research problems related to two basic organizational areas: the degree of utilization of information methods and techniques in internal processes, and the degree of digitalization of external communication processes. The following phenomena were identified as a result of the research. The results of the study on the utilization of information techniques in internal processes, including the use of tools and methods of digital communication, are as follows:



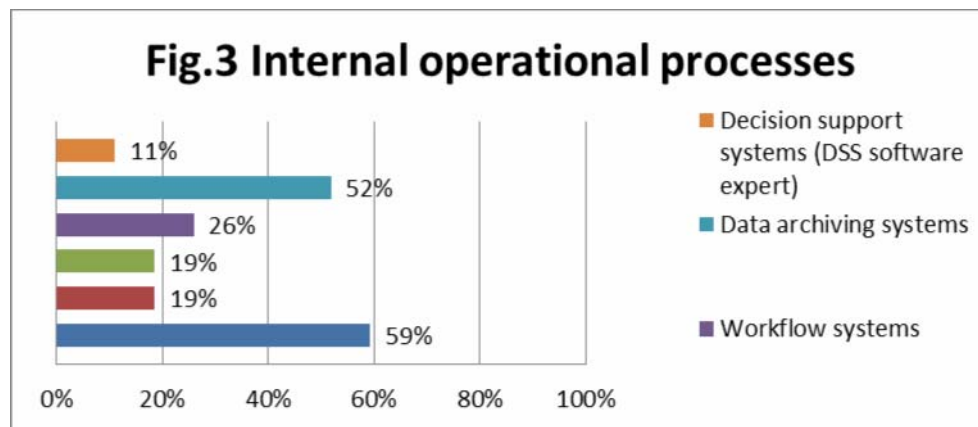
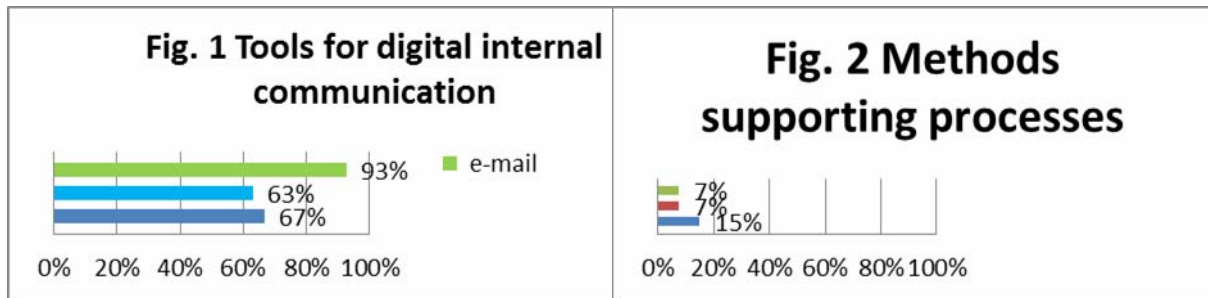


Figure 1. Source: own research

74% of the respondents use tools for digital internal communication (Fig. 1): as much as 93% of them use e-mail, 67%—websites, and 63%—instant messaging clients such as GG and Skype. However, much lower (i.e. only 10%) is the degree of utilization of information methods that support processes in an enterprise (Fig. 2). Only 15% of the respondents hold teleconferences. Even less entities take part in virtual and video conferences. Slightly higher, though still not too optimistic, is the degree of utilization of the cyberspace in internal operation processes (Fig. 3). Respectively: 59% of the respondents use their own financial and accounting system, 19% – human resource and payroll systems, 26% – e-documents circulation (workflow) systems, 52% – data archiving systems, and only 11% – specialized decision support programs. Taking everything into account, it can be concluded that the use of tools and methods of digital communication is at the low level of about 38% of the available tools. What is more, the studied enterprises use 42% of available tools of internal communication. 44% of them utilize tools for communication with suppliers (Fig. 4) and 40% – for communication with customers (Fig. 5). Most of the enterprises – as many as 25 units (93%) – use the cheapest form of exchanging information with both suppliers and recipients, which is e-mail. Relatively high is the extent of utilization of the instant messaging clients: GG and Skype (67% and 59%—for exchanging information with, respectively, suppliers and customers), and the degree of utilization of fax: 59% for communication with suppliers, and 44%— for communication with clients. 89% (24) of the studied entities have their company website.

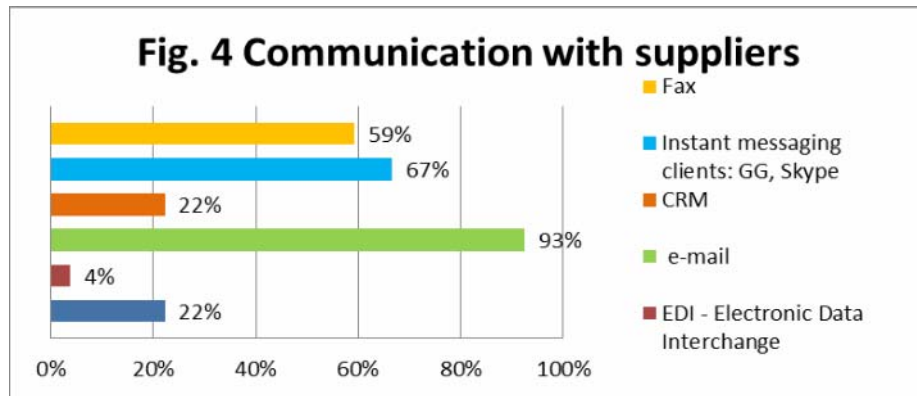


Figure 2. Source: own research

Much less common is the utilization of e-commerce systems (Fig. 5): 22% of the respondents use them for communication with suppliers (B2B), and even less, i.e. only 7% – for communication with customers (B2C). The use of CRM is also at a low level. It is used, respectively, by 22% enterprises for communication with suppliers and 19% – for communication with customers of tourism services. Even less popular is the system of electronic data interchange (4%), and call centre – there is only one case of a company that uses this form of communication. Electronic tools such as discussion groups, questionnaires, surveys, and e-WOMs, are utilized by only two of the enterprises (7%).

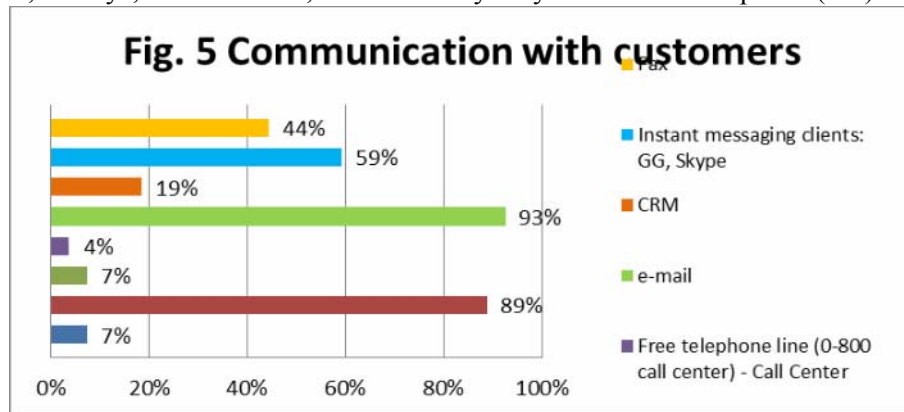


Figure 3. Source: own research

To summarize, the utilization of IT tools, apart from tools used for internal communication, is at a low level in the studied enterprises, and at a very low level, in the case of advanced techniques. The reasons for such a state of affairs can be found in the unsatisfactory degree of computerization in social and economic life, which is caused by infrastructure deficiencies. Thus, the low level of knowledge about available IT tools appears to be a natural consequence of this situation. A very important factor that influences the low level of computerization of the surveyed tour operators is the fact that the majority (i.e. as many as 78%) of the entities are small units which do business of a narrow market scope, have limited offer, and increase their activity only in the holiday period.

### The future of virtual space in tourism

The connection of tourism with information technology seems to be very strong due to the fact that tourism evolves towards significant changes and new challenges, which force new perspectives. Those can be identified in at least two dimensions: the development of new forms of individual tourism personalized to satisfy specific needs of the clients, and diffusion of increasingly sophisticated information and communication technologies in all spheres of social and economic life. [20] It is safe to say that all existing spheres of activity of tourism enterprises, such as: organization and management, contacting with co-operators, and the sphere of marketing and distribution, will have to be strongly supported by more and more recent IT solutions.

The overall technological development is not the only reason for the increasing degree of virtualization of the tourism of the future. Of great importance is also the „global economic situation,” [21] as well as political and climatic conditions. Rising prices of fuels, the effects of global warming, [22] armed conflicts, social unrest: all these factors have a huge influence on the present and future of tourism. Even now, they have helped to identify a wide range of needs related to searching for new communication and cognitive tools. Thanks to the virtual reality, a tourist of the future will be able to make a virtual tour around the place of a planned visit and select particular components of the tourism service so that they can personalize its final shape. With the use of the Internet, they will be able to monitor the weather conditions before departure, track selected transport connections, be warned about possible delays, and find opinions posted by other tourists. Even now, we can access places all over the world without leaving home thanks to the 3rd Planet (an interactive guide), or find details about a specific localization thanks to Google Maps GL. One of the applications, 3D Jinji Lake, launched in July 2013, enables you not only to see the Jinji Lake at your own pace with the use of a smartphone, but also to exchange impressions and information with other users and to share your photos and movies. [23] As far as the development of the organization and management sphere in tourism entities is concerned, the functionality of many of the enterprises can be in the future reduced to business activities performed only in the virtual space: without material resources, and based on the so-called e-offices that use telework. In the virtual space, business contacts will be in most cases restricted to teleconferences and video conferences, and will not necessitate moving to far corners of the world. Virtualization of the tourism of the future means also planning of the urbanization of tourism space. Thanks to digital technology, it will be possible to create „realistic representations of the development of tourism areas in numerous variants according to adopted solutions.” Visual simulations of individual solutions will contribute to a large degree to facilitating and accelerating the planning processes, e.g. by considerably shortening the period of public consultation. [10] Because of the fact that, as Gregory Ashworth has said, „Any attempt to predict the future is a journey into the unknown,” [24] this section shall be summarized with an endeavour to create a vision of the tourism of the future. The question: „what shall it be?” is left for the reader. Will the word „tourism” mean the same in several dozen years as it means today?

We claim that in the future, tourism will change its character completely. Thanks to the progress of civilization and development of information techniques, what seems unrealistic and unavailable in tourism today, will soon become everyday reality. The tourism of the future may be divided into tourism related to real-life objects and places (physical phenomena), and tourism of the virtual space. The emergence of virtual tourism seems to be a foregone conclusion. Its signals can be already found in the form of e.g. an application that enables us to visit the virtual Forbidden City or in the Jerusalem 3D Tours system providing us with a possibility to walk around Jerusalem. It will surely become an alternative to real-life tourism. Reasons for the development of this field should be found not only in low cost and time consumption of this form of recreation and education, but also in the fact that virtual tourism may constitute the only means of visiting places that are difficult to reach or closed from the public. Thanks to its development, the world will open not only for less wealthy social classes, but also for people who cannot move because of various ailments and those who just have little time. E-museums have become increasingly popular for the same reasons. The ones that already exist, such as the Gallery Systems or the International Centre of Photography in New York, enable us to browse through the works of most prominent artists in better and better technical conditions. Though it may seem mere fantasy, the authors believe that the times of cyber tourism are approaching. A moment when we will be able to have a tour inside the Great Pyramid, experiencing the specific character of this place with all our senses, is not so distant. In 2010, when 3D laser scanners were introduced for the civil public, a whole new reality opened for us. With these devices, it is already possible to create a digital multidimensional image of every material object with clockwork accuracy. Such an image, with the use of suitable software and equipment, can be recreated at any place and time to make an illusion of entering the newly-created reality. It can be stated with a great dose of conviction that electronic stimulation will soon become so advanced that apart from sight, our senses will be able to register the temperature of the environment, wind, smell and sound. The fact that this process is irreversible is supported by the overall development of civilization, the directions of which are indicated by specific behaviour of all economic units.

## RESULTS AND DISCUSSION

Modern IT tools for supporting the operation of tourism enterprises are used in all areas of activity of these organizations. They support organizational-management, information-marketing, and distribution processes, and play a key role in the exchange of information between all participants of tourism activities. Rapid development of the applications of the virtual space has been made possible thanks to the overall development of information and telecommunication technologies, which, in turn, was caused mainly by the expansion of the Internet.

## CONCLUSION

Technical possibilities created by information technology influence the creation of new trends in tourism to a large degree. For that reason, further development in this field will trigger inventing new applications for IT systems, which, in turn, will lead to developing tools that will substantially revolutionize human life in the near future. A tourist of the future will not only have the choice of personalizing the tourism product and using e-guide, but they will also experience numerous dilemmas, e.g. if they should choose to relax in the actual or a virtual reality. Its products have a chance of becoming the „fast food” of the 21<sup>st</sup> century tourism. Taking everything into account, it should be emphasized that the future of tourism enterprises is undoubtedly bound with the development of virtual environment, which may open for us numerous, yet unknown, options.

## REFERENCES

- [1] Sroka, H. 2009. Wybrane aspekty strategii budowy systemów e-biznesu. <http://www.swo.ae.katowice.pl/swo-2008>
- [2] Gołembski, G. (red.). 2009. Kompendium wiedzy o turystyce. Katowice: PWN. ISBN 978-83-01-15814-9, p. 271.
- [3] Bytniewski, A. (red.). 2009. Zastosowanie informatyki w agrobiznesie. Wrocław: Wydawnictwo Uniwersytetu Ekonomicznego. ISBN 978-83-7011-987-4. KamolMatouk, Aspekty technologiczne funkcjonowania zintegrowanych systemów informatycznych zarządzania w przedsiębiorstwach agrobiznesu., p. 12.
- [4] Berdychowski, J. 2011. Informatyka w turystyce i rekreacji. Warsaw: ALMAMER Wyższa Szkoła Ekonomiczna. ISBN 978-83-60197-99-8, p. 10.
- [5] Staszewska, J., Forystek-Zabojszcz, E. 2013. Wykorzystanie środowiska wirtualnego w przedsiębiorstwie turystycznym na przykładzie organizatorów i pośredników turystyki województwa opolskiego. Opole: International Scientific Conference on Management of organization in realand virtual environment: opportunities and challenges 2013.
- [6] <https://www.web.gov.pl/firmy-i-uslugi/katalog-b2b>
- [7] Dąbrowska, B. 2006. Rozwój usług turystycznych w warunkach globalizacji. Gdańsk: Wyższa Szkoła Turystyki i Hotelarstwa. ISBN 83-89081-02-4, pp. 35, 64.
- [8] Buhalis, D., Law, R. 2008, Progress in Information Technology and Tourism Management: 20 Years on and 10 Years After the Internet – The State of E-Tourism Research, August 2008. Tourism Management, 29(4), p. 609.
- [9] Nalazek, M., Moskała J. Internet w turystyce i hotelarstwie. Informatyka w hotelarstwie. Polskie Zrzeszenie Hoteli, Ministerstwo Gospodarki, ISBN 83-918194-1-8, pp. 67, 74.
- [10] Pawlicz, A. 2012. E-Turystyka. Warsaw: PWN. ISBN 83-01-17063-9, pp. 67, 118, 123.
- [11] Meyer, B. et. al. 2006. Obsługa ruchu turystycznego. Warsaw: PWN. ISBN 978-83-01-14820-1, pp. 197-198.
- [12] Jamal, T., Robinson, M. 2009. Tourism Studies. London: SAGE Publications Ltd. ISBN 978-1-4129-2397-2. pp. 566-567, 559.
- [13] WTO. 2001. E-Business for Tourism. Practical guidelines for Tourism Destinations and Business Council Conseil Professionnel OMT 2001.
- [14] Sroka, H. 2005. Strategia i metodyka budowy systemów e-biznesu. Katowice: Wydawnictwo Akademii Ekonomicznej. ISBN 97883-7246-303-4, p. 18.
- [15] Bosiacki, S., Śniadek J. et. al. 2004. Metodyka i technika obsługi ruchu turystycznego. Poznań: Akademia Wychowania Fizycznego. ISBN 97883-88923-4-4, pp. 175-176.

- [16] Dong, J., Woo, G., Jin, S. 2006. A Perceptual Mapping of Online Travel Agencies and Preference Attributes. *Tourism Management* 28 (2007), pp. 591-603.
- [17] Buhalis, D., O'Connor, P. 2005. Information Communication Technology Revolutionizing Tourism. *TourismRecreationResearch*, Vol. 30(3), 2005, p. 12.
- [18] Ruszkowski, J. 2006. Nowoczesne systemy informatyczne narzędziem informacji w turystyce. *Informacja Turystyczna, Zeszyty Naukowe* Nr 429, Szczecin: Wydawnictwo Uniwersytetu Szczecińskiego. ISBN 1640-6818.
- [19] Konieczna-Domańska, A. 2008. *Biura podróży na rynku turystycznym*. Warsaw: PWN. ISBN 978-83-01-15669-5, p. 127.
- [20] Stamboulis, Y., Skayannis, P. 2003. Innovation Strategies and Technology for Experience-Based Tourism. *Tourism Management* 24 (1), p. 35.
- [21] <http://www.tomorrowstourist.com/pdf/004>, What Will the Tourist Be Doing in 2030. Chapter 4, p. 41.
- [22] Francis, J. The Future of Travel. <http://www.responsibletravel.com>
- [23] Liao, R. 2013. 3D Jinji Lake. <http://technode.co/2013/08/07/>
- [24] Ashwort, G. <http://www.tomorrowstourist.com>

## REGIONAL DEVELOPMENT AGENCY FOR SMEs AS A FACTOR OF ECONOMIC DEVELOPMENT OF LOCAL COMMUNITIES

Vlado Medaković, Slaviša Moljević, Srđan Vasković

University of East Sarajevo, Faculty of Mechanical Engineering, East Sarajevo

e-mail: [vlado.medakovic@gmail.com](mailto:vlado.medakovic@gmail.com), [slavisavgd@gmail.com](mailto:slavisavgd@gmail.com), [srdjan\\_vaskovic@yahoo.com](mailto:srdjan_vaskovic@yahoo.com)

**Abstract:** The aim of this paper is to show the importance of development agencies on the economic development of regions and local communities, and the relationship between development agencies in terms of starting and existence of small and micro enterprises. Regional Development Agencies as carriers of development for regions directly affect on the steady economic development of the region and therefore on the economic development of local communities.

**Key words:** Development Agencies, small and micro enterprises, local Development

### INTRODUCTION

Today, the very presence of the opinion that entrepreneurship and micro, small and medium enterprises, the main and most important factor in solving many problems in ensuring a successful economy and overall economic development. Entrepreneurship and SMEs undoubtedly have great significance in terms of employment, successful business and economic development. To SME sector had a significant role in the development should have a much longer tradition than that of in our area, where the earlier period of little or no importance has been given to entrepreneurship and SMEs. Contemporary theory and practice of development and improvement of SME and their success depends on the financial and non-financial support from institutions, whether governmental or non-governmental organizations.

Republic Agency for Development of Small and Medium Enterprises in the Republic of Srpska was established in accordance with the Law on encouraging the development of small and medium-sized enterprises, and it has began work in September 2004th year. It works as a legal entity and non-profit organizations. The agency provides support to the establishment and development of small and medium sized enterprises in the Republic of Srpska and it is generator of the overall system to support the development of small and medium enterprises.

The main objectives of the Agency are to increase the participation of SMEs in the economy of the Republic of Srpska, changes in the business structure by increasing the share of manufacturing activities and services in the gross domestic product, increased technological development, competitiveness and open new markets for small and medium businesses, increasing the number of businesses and new workers in these enterprises and regional cooperation with neighboring countries in order to exchange experiences and achievement of regional comparative advantages for entrepreneurship.

The Agency has the task of drafting documents on the development of Small and Medium Enterprises of the Republic of Srpska operationally implemented incentive policy, promote employment, vocational training, re-training and re-training of workers, establish and encourage communication return small and medium-sized enterprises, entrepreneurs and their associations with the Government and other institutions in the RS and BiH. Agency should encourage the initiation and development of local development agencies and local centers for business development, assist and coordinate the development of a network of local development agencies and encourage inter-municipal projects, promote entrepreneurship and support business innovator, organize, collect and process legal and other information of interest small and medium-sized enterprises, the establishment of a single information system statistical data and information relevant to the small and medium enterprises, to participate in international projects and their implementation, to support initiatives of the private sector and the winder experiences of best practices at all levels.

From the standpoint of supporting entrepreneurship and SMEs, most of the work is, and should remain at the entity level and lower levels, ie. at the level of economic regions and local communities, which have long lead various activities to support SMEs. Shortcomings in the existing legal framework for

SMEs are not being adequate infrastructure to support the business, as well as difficult and complicated access to credit. This lead to large obstacle to the development of entrepreneurship and SMEs in RS compared to most other countries in the region.

### THE WORLD PRACTICE AND EXPERIENCE OF FOSTERING SMEs AND ENTRENEURSHIP

At the end of the last century, the pursuit of the creation of a large number of SMEs, entrepreneurship has become a significant factor in economic and social development around the world. When it is revealed as a very important state role at the national, regional and local level support the development of entrepreneurship.

Start of establishing institutional networks to provide institutional support to the SME sector, the dates from the eighties, when he noticed the importance of SMEs in the economic reconstruction of the UK. Schematic representation of the possible support network for SMEs is shown in Fig. 1.[1].

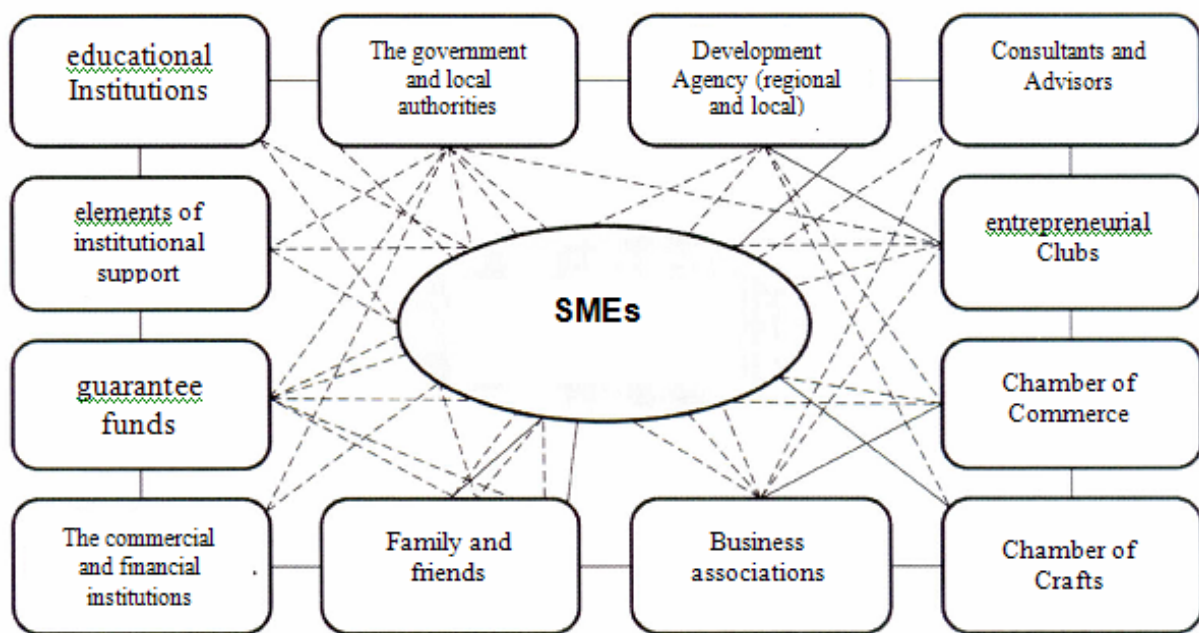


Figure 1. Support Network for SMEs [2]

By organizing the first common policy framework to support SMEs in the EU in 1986. he began to create the Action Programme for SMEs. Measures of the Action Program initiated a number of activities in the elimination of administrative, financial and legal constraints for the operation of SMEs and to encourage cooperation and partnerships for SMEs. Forms of assistance for SMEs: Help for Beginners Business Assistance to existing businesses in the growth and development, particularly in special situations (new products, new markets, innovation, exports, technology transfer, networking and co-operation contract, the placement of financial instruments), and support for existing businesses that found themselves in difficulty[1].

In essence, the structure and form of assistance to small and medium-sized enterprises are varied and depend on many circumstances in the respective country, but it is important to learn the practice of some countries and the need to adjust the observed environment, during the establishment and operation. Also from state to state aid has a variety of programs and performers. Basically these are national, regional and local governments, nonprofit organizations, and commercial providers.

Typically, entrepreneurs are not satisfied with the action of institutions for support and assistance. Comments relating to the bureaucracy of the institution, offering abstract knowledge unadjusted needs of entrepreneurs, because they tend to view problems in lack of funding.

## **SITUATION IN THE REPUBLIC OF SRPSKA FROM THE ASPECT OF SUPPORT TO DEVELOPMENT ENTREPRENEURSHIP AND SMEs**

In this way the great historical transformation of the former socialist self-management of the economy to a market economy, the state should play a major role. The crucial question that arises for BiH as a whole is a question of the ability to find a balance between the power of decision-makers in government structures and their functions versus the population as a whole, ie. question of striking a balance between the category of authority and responsibility categories. In this context, if the state promotes regional economic development, the region continues to face the process of their efforts in the promotion and implementation of the development process. At the same time creating and accountability region to foster not only their local area, but also to create the conditions for future integration process of individual regions of a single economic space, with the aim of improving the quality of life both within individual regions, and the entire area Bosnia. To support the development of small and medium-sized enterprises in the Republic of Srpska gained in importance 2002nd the adoption of the Program of small business development for the period in 2002. - 2005th years, after which he adopted the Law on Promotion of Small and Medium Enterprises SMEs.

The adoption of the Act created the conditions for the legislative, institutional and financial support to this area During the 2004th pursuant to the Act have been established: the Department for SMEs and manufacturing trades in the then Ministry of Economy, Energy and Development and the Republic Agency for Development of Small and Medium Enterprises. At the same time the local establishment local agencies for the development of SMEs so that by 2009. was formed of 18 local agencies, and a number of municipalities have expressed interest in establishing them. Support the development of SMEs at the local level and also provide for the development of municipal departments that together with these institutions form a network to support the development of SMEs. Institutional support to the SME sector is one of the strategic priorities in the overall system of support the SME sector. Looking at the institutional support for the development of the SME sector, we distinguish between two support levels: national and local, The Law on encouraging the development of SMEs, in Article 14 defined by the holders of the Strategy of development of SMEs, some of which are at the level of the most important Ministry of Industry, Energy and Mining and the Republic Agency for SME Development. It is important to note that the Government of the Republic of Srpska late marta 2009. was appointed by the Council for the Development of SMEs and Entrepreneurship of the Republic of Srpska with the principle of focusing on small businesses.

As the process of local economic development taking place within the local government level, and the process of European integration the local level is increasingly more active role in creating a favorable business environment, strengthening institutional support and infrastructure for the management of development processes is gaining in importance.

One of the main activities of local development agencies is that their work considered strategy implemented to encourage the development of SMEs at the national level. However, in practice, it often happens that the local development agency primarily tasked to coordinate and facilitate the process of local economic development overall. The very role of local development agencies stems from the needs of a unit of local government who is the founder of the agency. On the one hand, there are agencies that are highly specialized for specific types of support the SME sector, the agency aimed at the overall development of the municipality and are the main implementers of the overall local development strategies. According to the analysis infrastructure for the management of development processes in the Republic of Srpska there are 18 local development agencies or 28.57% of the total number of local authorities[2].

Less government units have been formed separate organizational units outside the institutions of local government, but in the very institutions established departments for development, particularly in small and underdeveloped local government exists only report that performs the role of managing the process of local economic development. Local governments that have this kind of planning institutions to processes of local economic development is 31 or 49.18% of the total number of local government units in the Republic of Srpska[2].

A certain number of units of local government has not developed any form of organization infrastructure for management of development processes, and 15 local government units or 23.84 % of the total number of local government units in the Republic of Srpska[2].



Fig. 2. Shows the territorial representation of SMEs by economic regions.

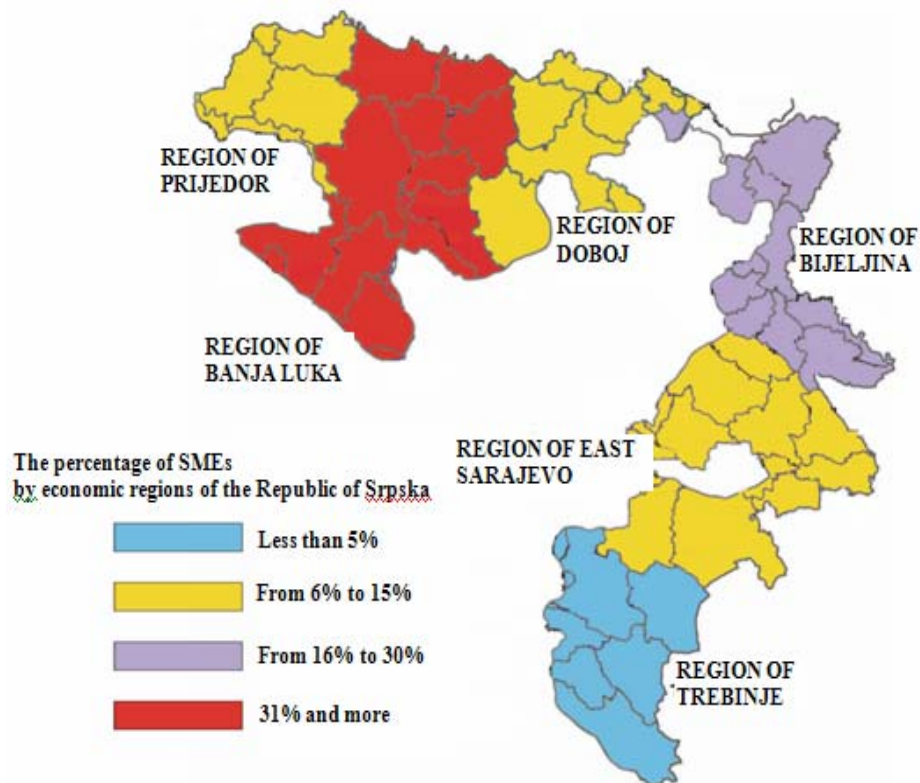


Figure 2. Territorial representation of SMEs by economic regions[2]

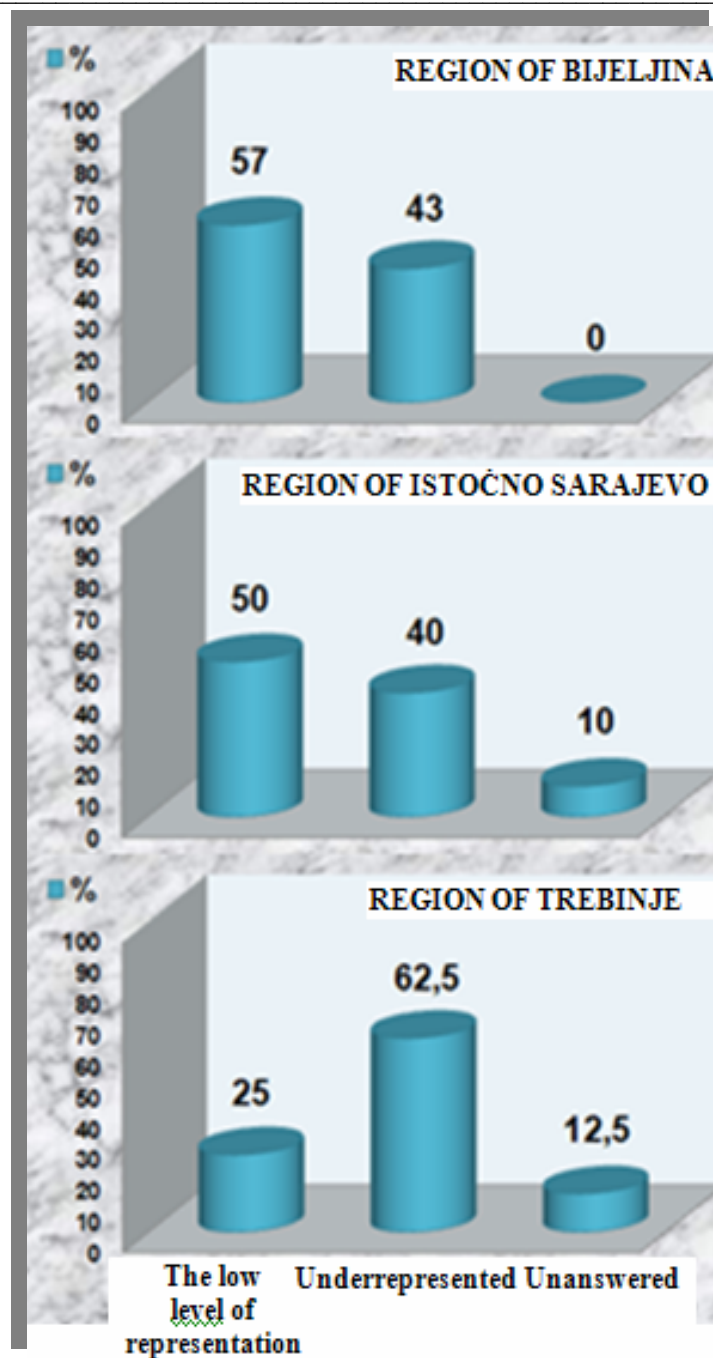
## EMPIRICAL STUDIES INCENTIVES SMEs AND ENTREPRENEURSHIP FROM REPUBLIC AGENCY FOR DEVELOPMENT OF SMEs

The research process was carried out in the territory of the Republic of Srpska, which is divided into six economic regions, namely: Banja Luka, Bijeljina, Doboј, Prijedor, East Sarajevo and Trebinje. The research involves the extent to which the Republic Agency SMEs in the Republic of Srpska supports and services to small and medium enterprises and entrepreneurs in different economic regions. The results were relevant municipal services, entrepreneurs, owners of micro, small and medium enterprises in the municipalities in which the research was conducted, and the emphasis was placed on three economic regions: Bijeljina, Trebinje and East Sarajevo.

Selection is based on the fact that these three regions territorially linked, geographically located in the eastern part of the Republic of Srpska, percentage of small and micro enterprises in the total number of SMEs in the RS is lower than in the other three regions, as can be seen from Figure 2, a very small number of local development agencies, which presents relevant business unit in terms of a given study.

## RESULTS AND DISCUSSION

The research, conducted in the Republic of Srpska, ie. in its three economic regions: Region Bijeljina Region East Sarajevo and Trebinje region, I came up with an answer to the question: To what extent is represented stimulation of your work by the Republic Agency for SME Development of the Republic of Srpska? The results of the responses given by the surveyed participants in the study are shown in Figure 3.



**Figure 3.** The level of representation of the stimulus SMEs Republic Agency for Development of SMEs[1]

## CONCLUSION

Developed countries have identified the importance of regional development agencies and their effective use in terms of improving the living standards, raising the level of environmental protection, as well as increased employment. Regional development requires the use of regional resources and resources as the other Republican Agency is not able to stay up all measures and to manage resources in all regions solely because of the lack of information in terms of potential. RDAs should have strategies and plans for initiating and encouraging SMEs and entrepreneurs in a given region, which will be coordinated with the national level will be realized.

Each region has its own characteristics, in terms of resources and infrastructure, and directing them to be in the direction of achieving the best effect, which is reflected in their efficient use. In the Republic

of Srpska gradually creates a favorable environment for the development of SMEs and entrepreneurship, primarily to strengthen financial support and infrastructure. Local communities and municipalities, should direct their activities towards the improvement of infrastructure, to harmonize their rules and regulations with institutions of the region and the state work together to provide the best possible environment for start-up and survival of SMEs. Local government is the holder of shaping the development strategy of the region and the community the municipality and its entrepreneurial advocate. Deliberately encourage the local community to own the development of infrastructure and entrepreneurial potential and attract investments automatic is a concept of regional development. Each of the six economic regions of the Republic of Srpska has its potential for development, including infrastructure, resources used, and potentially exploitable resources, each in its own way in terms of the given potential.

## REFERENCES

- [1] Medaković, V., RESEARCH OF CONDITIONS FOR DEVELOPMENT OF SMALL AND MICRO ENTERPRISES AND DEVELOPMENT OF ENTREPRENEURIAL INFRASTRUCTURE MODEL, Doctoral thesis, Faculty of Mechanical Engineering, East Sarajevo, 2012.
- [2] The Government of the Republic of Srpska: Annual report for the area of small and medium-sized enterprises and craft - entrepreneur activities in the Republic of Srpska 2009th year, 2010.
- [3] Jojić, R., Božić, R., Preduzetništvo za novi vek, East Sarajevo - Pristina, 1998.
- [4] Jojić, R.: Management, Institute for Economics and Development, East Sarajevo, 2002
- [5] Ökmen, M., Özer, B., Bal, V., An Evaluation Of Regional Development Agencies' Roles In Regard To Social Sustainability: A Discussion Of Turkish Development Agencies' Experience, 3rd International Symposium on Sustainable Development, Sarajevo 2012.
- [6] Petkovic, D, Hadžić, A., REGIONAL DEVELOPMENT AGENCIES AND THEIR ROLE IN QUALITATIVE MACROECONOMICAL B&H DEVELOPMENT, 3rd Scientific Conference with International participation "KVALITET 2003" Zenica, 2003.

## KNOWLEDGE MANAGEMENT AND DEVELOPMENT PERSPECTIVES OF COMPETITIVENESS OF SERBIAN COMPANIES

Duro Kovačević<sup>1</sup>, Cariša Bešić<sup>2</sup>, Radomir Stanišić<sup>1</sup>, Snežana Bešić<sup>3</sup>

<sup>1</sup> SP Lasta AD, Beograd, Serbia

<sup>2</sup> University of Kragujevac, Faculty of Technical Sciences, Čačak, Serbia

<sup>3</sup> Serbian Railway AD, Beograd, Serbia

e-mail: [kovacevic.duro@gmail.com](mailto:kovacevic.duro@gmail.com)

**Abstract:** In the globalized economy knowledge becomes the basic resource. Management of the organization, which is based on the knowledge involves restructuring the business functions of the company – instead of the equal treatment of all business functions of the company, the attention must be focused on specific business functions inside a strategic dimension. These functions are marketing, quality and research and development. These business functions are based on the concept of knowledge management. The focus of the marketing strategy is the ratio of product-market. Most companies have to look up to companies in newly industrialized countries. These companies have managed to maintain a competitive advantage in times of crisis by insisting on improving business productivity, standardization of quality and continuous improvement of knowledge.

**Key words:** Knowledge, Competitiveness, Management, Business, Quality

### INTRODUCTION

Contemporary business environment demands new methods of action directed towards the achieving competitiveness. Management challenges are now far larger and heavier than they were just twenty years ago. The global economy affects the overall interdependence and connection of national economies and companies. According to Kotler (2009), the world is connected and interdependent more than ever. The global economy is characterized by the appearance of hyper-competition. Hyper-competition happens when technologies and offers are so new that the standards and regulations are fluid causing competitive developments that cannot be stopped. It is characterized by intense and rapid competitive advances in which competitors have to quickly build new advantages and surpass their rivals.

According to Sajfert et al. (2006), globalization is a process by which the company operations spread to the whole world space and strategic position of competitors in the national markets depends on their overall global position. General measures - leverage of business globalization are as follows: participation on the global market, global product development, and global business locating within the world geographic space, global marketing, and global competitive strategy. Market globalization results in the appearance of global companies and global industries - a global industry is one in which the strategic positions of competitors on the specific geographic or national markets depends on the position of firms in other countries in the world. The result of market globalization is the establishment of global competition which is very intense. Companies from developed countries compete with enterprises from newly industrialized countries and countries in transition.

China and India have given a new dimension to the world economy, which includes productivity as a major imperative. Next to China and India, Brazil and Russia play an important role on the global stage, and they are joined by South Africa. By the nineties of the twentieth century, the global economy was dominated by the U.S., Japan and Germany. Today, the image of global economy leaders seems somewhat different - the U.S. is still the first economy in the world, followed by China and Japan.

## MANAGING THE COMPANY ON THE GLOBAL MARKET

In today's economy the most resourceful and the smartest individuals win no matter where they come from. New business conditions, which are defined by rapid technological development, market globalization, hyper and negative effects of the global economic crisis, require new responses to the management of the company. According to Adizes, management must change proactively and synchronize subsystems. This makes the organization strong, (2009).

This market reality requires the establishment of a new model of organizational management. A new time has shown that large corporations, burdened by unnecessary bureaucratic administration and management lose the race compared to the regular less enterprising corporations, especially those from the newly industrialized countries of the world. The crisis of 2008, which is still ongoing, revealed that old and outdated methods of business and organization management have to be overcome and replaced by management methods and techniques that are based on improvement of knowledge efficiency. According to Hamel (2009), management is outdated. Like the internal combustion engine, it is a technology that has largely stopped evolving, and it is not at all good. Why? When it is less successful than it could be, or should be, we all pay the price. What ultimately limits the performance of your organization is not its operating model, nor its business model, but its management.

According to Kotler (2009), at the heart of the traditional approach to strategy lies the assumption that by conducting the set of powerful analytical tools, managers can predict the future accurately enough to choose a clear strategic direction for themselves. When the future is truly turbulent and reaches a high level of chaos, this approach is at best only marginally useful, and in the worst case, truly dangerous. Managing the organization, which is based on the knowledge, involves restructuring the business functions of the company - rather than the equal treatment of all of the company, attention must be focused on specific business functions inside a strategic dimension and defining the competitive position of firms in the market. These functions are marketing, quality and research and development. These business functions are based on the concept of knowledge management. The focus of the marketing strategy is the ratio of product-market. The quality is based on the continuous improvement of operations which is based on the fight to increase business productivity. Exploration and job development is aimed at creating new technical solutions that should give the company a competitive advantage in today's turbulent market.

Modern organizations should be intense in accepting knowledge. According to Sajfert et al (2005), knowledge intensive organizations are the ones that pay special attention to the knowledge of employees, which is why it is said that they are knowledge intensive organizations, which are becoming a major resource of the organization. A modern organization has to be innovative. Innovation is the basis of business development. The level of innovation affects the acquisition of competitive advantage. In the view of Drucker (1995), the main milestones in the entrepreneurial economy must be productivity and innovation. Business success of an organization can only be achieved by improving the productivity of key business resources and the current level of business innovation.

Most companies have to look up to enterprises from newly industrialized countries. These companies have managed to maintain a competitive advantage in times of crisis, insisting on improvement of business productivity, standardization of quality and continuous improvement of knowledge. For example, China is insatiable when it comes to its interest to listen, learn and develop in accordance with proven best solutions obtained in different parts of the world, and to assess what he calls "the trends of time in which we live. China performs a thorough assessment of global and regional environment and in accordance with that assessment defines its policy - adapting to the environment in this way (Bersten et al, 2011). In the view of American professor and expert for the global markets of Indian origin Mahayana (2007), the crisis will show how strong we are and how inventive we can be. In this crisis, many companies will start to think about innovation. Future scenario will deal with it where to find growth. The growth will come from developing countries.

## THE ROLE OF KNOWLEDGE IN THE QUALITY DEVELOPMENT OF CONTEMPORARY ORGANIZATION BUSINESS

Jay Conrad Levison (2005), the author of the marketing bestseller in the world *Guerilla Marketing*, notes that creativity begins with knowledge. Modern society is a knowledge society according to Drucker - knowledge has become the main resource of useful good. In the information society, knowledge is becoming the main economic resource. **Knowledge is becoming the crucial factor of production.** In the new knowledge society will become a strategic source of power and wealth, and basic social groups will be **knowledge users**, or people who are able to put their knowledge of the function of a business. Drucker calls them "**knowledge workers**". It is a society where instead of "responsibility for the performance of people" comes "responsibility to apply knowledge and performance that is achieved thanks to that."

According to Sajfert et al (2005), the operational definition of knowledge is the purpose of understanding and action patterns that govern the senses, the decision of creation, implementation and installation. Knowledge implies facts, concepts and perspectives, psychological reference models, truths and beliefs, prejudices and expectations, methodologies and know-how. Knowledge is used to interpret the information on the basic circumstances or the case how to manage the situation. Knowledge is the recognition which facts and information are relevant in the context of the situation. Knowledge possesses and represents many conceptual levels, in many forms, many types and many areas. Even Deming noted that the path of deep knowledge leads into transformation (1996). The system of profound knowledge was drafted in 4 parts and all of interconnectedness - understanding and appreciation of the system, knowledge of variation, theory of knowledge and psychology.

Knowledge management according to Sajfert et al (2005), implies a systematic, explicit and deliberate building, renewal and application of knowledge to improve the effectiveness of the business functions of the company in terms of knowledge and profit based on expert knowledge and the major intellectual advantages. This area covers a calculated and systematic analysis, synthesis, evaluation and implementation of changes in knowledge in order to achieve a set of goals and test whether the activities related to the knowledge management are performed adequately, whether the goals are reached. It includes activities required to facilitate the work that is directly related to knowledge: involves adapting the ways of thinking about benefits of knowledge management, which are necessary for the creation, maintenance and use of appropriate indefinite capital.

## THE IMPROVEMENT OF KNOWLEDGE PRODUCTIVITY AND THE DEVELOPMENT OF THE COMPETITIVENESS OF DOMESTIC COMPANIES

It is well known that domestic companies are insufficiently competitive on the international market. This trend has continued for nearly twenty-five years, and is particularly developed in the last five years, due to the cumulative negative impact of the global economic crisis and transitory recession. In the late eighties and early nineties of the twentieth century, it was clear that local companies are not competent on the international market and that the main reason is the lack of productivity of the business. The average age of equipment in Serbia is 29.5 years, which is two decades behind the EU average. This is determined on a representative sample of 154 small, medium and large companies in six industries with similar production programs. Austria is taken for the criterion because of approximately the same natural, social and population characteristics as Serbia. The businesses that are lagging behind the most are in the field of textiles (35), followed by enterprises from machinery industry (34.5 years). The businesses that are lagging behind the least are the pharmaceutical business functions of the company with a delay of 21 years. Regionally seen, equipment, tools and other productive assets fall behind in Southern Serbia (41 years), and the best condition is in Backa (lag of 18.5 years). In Belgrade the lag is 20.5 years.

According to the survey of the National Statistical Office (RSO) on innovation activities in companies in Serbia in the period 2008-2010, carried out on a sample of 3,982 business entities came to the conclusion that of total number of the surveyed enterprises 47.9% participate in any form of innovation. Research of the National Bureau of Statistics shows that domestic companies surveyed (regardless of the size of the company) are mostly facing the innovation in the organization of (28.8), while the second largest representation of process innovation and innovation in marketing with 26.2%. The problem is that innovation of products / services is the least present the innovative activities of companies which may be related to the still low level of investment in research and development in companies. When it comes to expenditure for innovation activities, the greatest part of investments relates to the purchase of machinery, equipment and software, and it is 75.1%. The Republic of Serbia has analogous to the standard ISO 9000 series and now has fully complied with international standards and European commitments in terms of development and improvement of the quality management system. The number of companies that has certificates is around 2,200 companies, which is not enough. The majority of companies that have introduced quality management system are major companies. The reason for the relatively small number of local companies that have introduced quality system is in a difficult financial situation in the domestic economy - in the last 10 years, domestic companies were in a chronic lack of funds, and the introduction of quality system of business requires significant efforts that the company needs to invest in the implementation of this concept. According to a new report by the World Economic Forum, which covered 148 countries in the world, Serbia is ranked 101 in the world which is a drop compared to the previous year, when Serbia was on 95 place. This year, Serbia has found itself with Algeria (100th), Guyana (position 102), Lebanon (103 place) and Argentina (104th place). From the countries in the close environment, Hungary is on the 63rd place, Bulgaria is on the 57th, Romania is on the 76th place, Greece ranks 91 and Albania is on the 95th place.

Without constant use of knowledge in processes of governance organization there is no economic progress. This is best illustrated in an example of Far Eastern countries which have put the process of improving knowledge on the first place priorities and linked with the constant struggle to increase business productivity. For example, the Japanese have overcome the problem of resource poverty constant improvement of knowledge, using the already existing and proven knowledge that is coming from the West, with the aim to present concepts and techniques in advance. Fighting for quality and productivity in Japan has always had national significance. According to some beliefs, as well as basic courses of action aimed at improving the domestic enterprises can be seen as follows:

- broader and more comprehensive application of the concept of benchmarking in local business organizations,
- wider and faster acceptance of the concept of quality and international standard series ISO 9000:2000,
- continuous improvement of the knowledge of all employees in local business organizations, in particular executive management,
- modified behavior based on the application of modern management techniques,
- market acceptance of business logic,
- creating successful brands based on combining the effects of quality improvement, product differentiation and integrated marketing communication,
- Achieving customer satisfaction is the basis for the formation of loyalty in relation to the brand, (Besic, 2005).

## CONCLUSION

Innovation in general, and especially innovation and the development of management skills and knowledge of local managers is a key point for the successful restructuring of the national economy. From the perspective of domestic enterprises, improving the process of the knowledge management is the crucial factor for the successful market positioning and market development. There is a need for continuous improvement of knowledge and skills of employees, especially managers. Special attention must be paid to **the implementation of new approaches to the management of business**

**organizations**, both conceptually and in terms of organization. The main direction for the improvement of competitiveness of domestic enterprises is **the improvement of the quality of operations and increase in productivity**. This can be done on the basis of **a continuous improvement in productivity of knowledge** of employees in domestic enterprises, in particular to the advancement of knowledge managers.

## REFERENCES

- [1] Adžes I. (2009). Kako upravljati u vreme krize, Asee, Novi Sad.
- [2] Bersten F., Frimen Č., Lardi N., Mičel D., (2011). Uspon Kine, Službeni glasnik, Beograd.
- [3] Bešić C. (2005), Primena koncepta benčmarkinga u domaćim poslovnim organizacijama, zbornik radova 8. međunarodne konferencije DQM 2005., Istraživački centar DQM, Čačak, 2005., str. 645-651.
- [4] Deming E., (1996), Nova ekonomska nauka, PS Grmeč – Privredni pregled, Beograd
- [5] Drucker P., (1995). Menadžment za budućnost, PS Grmeč – Privredni pregled, Beograd
- [6] Hamel G., (2009). Budućnost menadžmenta, Asee, Novi Sad.
- [7] Kotler P., Caslione J., (2009). Kaotika, Mate, Zagreb.
- [8] Kramaršić M., (2005). Iskrice marketinga, Kramaršić Miloš, Beograd.
- [9] Mahajan V., Banga K., (2007). Rešenje za 86%, Mate, Beograd.
- [10] Sajfert Z., Adamović Ž., Bešić C. (2005). Menadžment znanja, TF "Mihajlo Pupin", Zrenjanin.
- [11] Sajfert Z., Đorđević D., Bešić C., (2006). Leksikon menadžmenta, TF "Mihajlo Pupin", Zrenjanin.
- [12] The Global Competitiveness Report 2013-2014., World economic forum.



## IMPROVEMENT FACTORS OF COMPETITIVENESS OF DOMESTIC COMPANIES

Snežana Bešić<sup>1</sup>, Đuro Kovačević<sup>2</sup>, Cariša Bešić<sup>3</sup>

<sup>1</sup>Serbian Railway AD, Beograd, Serbia

<sup>2</sup>SP Lasta AD, Beograd, Serbia

<sup>3</sup>University of Kragujevac, Faculty of Technical Sciences, Čačak, Serbia

e-mail: [snezana.besic@srbrail.rs](mailto:snezana.besic@srbrail.rs)

**Abstract:** The main goal of modern business is to achieve operational excellence and achievement of world-class products and services. This can be achieved only by the continuous improvement of the quality of the business, which is based on increasing the productivity and knowledge of each individual employee in the organization. Quality and productivity represent a starting point for process improvement business a modern organization.

**Key Words:** Competitiveness, Productivity, Competitiveness, Management, Business, Quality

### INTRODUCTION

In today's economy productivity is one of the most important factors of competitiveness of the organization. Improving business productivity is an imperative of contemporary business. It involves the creation of conditions for improving the efficiency of knowledge, and consequently productivity. The battle for competitive advantage is primarily a struggle for business productivity. The success of the company is significantly associated with the concept of integrated quality, enabling competitive advantage by improving the productivity of business. Quality becomes the primary development goal, objectified through **the achievement of operational excellence and achievement of world-class products and services**, while the holders of the improvement of the quality are employees of the organization, from top management. Employees are the ones who created the quality of operations, based on improving the productivity of their knowledge and work.

Quality and productivity are inextricably linked. Improvement of quality affects on lowering operating costs because of less rework, errors, delays, rejects and better utilization of equipment and raw materials, in a word for better management of business resources. Lowering the cost of doing business directly affects the increase of productivity. Lower costs and higher productivity affect the flexible price policy - manufacture and sale of standard quality at lower prices than the competition. Optimization of cost-quality relation affects the capture of a stable market position, achieving development goals - provides jobs and creates new jobs. Successful business, especially at the international level, means of product differentiation, quality and efficient marketing communication. Domestic companies have had difficulty during the last twenty years with all three of the apron.

### BASIC COMPETITIVENESS FACTORS

Integrated quality concept is one of the most important factors in achieving a stable market position in modern business. Integrated quality concept includes all the quality elements that relate to consumers and users, and to achieve customer satisfaction and quality improvement. The quality of a specific product or service is only one element of the concept of market quality, but it also marks the start and end point of the entire cycle of improving the quality of operations. The concept of quality management is primarily a market concept, which is based on the improvement of all business activity, ranging from market research, product development and production, logistics, marketing communications and business impact evaluation. General results concerning the application of international standards of management and the development of integrated management systems are insufficient at the local market. The negative effects of the global economic crisis have led to some companies lost certificates of introduced standards, both due to lack of funds needed to maintain the system as well as layoffs and the loss of markets. Improving the productivity of the business as one of

the imperatives of the modern economy requires improvement of the organizational structure. According to Besic and Djordjevic (2007) it is particularly important that the organizational structure is propulsive for information as a hierarchical vertical, and the horizontal level. Modern organizations require productive project teams, where no existing leader - each team member must have both leadership skills and entrepreneurial abilities. Strong leadership personalities of the twentieth century were replaced by strong teams of individuals who are willing to work through team answers the challenges of the future. Creativity, innovation and the advancement of knowledge are the basis of successful project teams.

According to David Ogilvy, one of the greatest practitioners in the field of marketing and founder of the marketing company Ogilvy and Mather, most businessmen are incapable of original thinking because they are unable to escape the tyranny of reason. Marketing professionals and executives need a new way of thinking, which is not directly burdened by old conceptions of rationality, which have their roots in the theories of the early 20th century. Until the beginning of the transition process, marketing functions, particularly its communication component had adequate treatment in the mix of business functions of local companies. The legacy of the socialist economic system dictated that production is crucial to the success of the enterprise, regardless of other factors, such as market information, research and development, product compliance with requirements, cooperation with competition.

The main problem encountered by most of the companies on the market in the field of marketing practices is the lack of implementation of the marketing concept. The main problems we face in our country when it comes to marketing are as follows:

- **Failure to adopt the logic of marketing** - marketing must be accepted not only as a business function, but also as a concept, as a business philosophy, which is fundamental to every company, which operates the market.
- **Misunderstanding of integrated marketing concept** - general acceptance of marketing can result in counterproductive effects on the company - marketing mystification or voluntary approach. Large part of domestic companies marketing serves as an element of business that is used in order to distance itself from the legacy of the past, not because of the real need to switch to market and profit thinking.
- What is the characteristic of our company is **the misconception of marketing**. Marketing is identified with the promotion, mostly from advertising.
- **Inadequate treatment of marketing investment** - an investment in marketing, particularly in the promotion, is not a pure expense, but an investment which will show effects only in the future by building a market position and reputation of the company.
- **Issues of organizational structure** - it is necessary to clearly define the position of marketing within the company in relation to the functions that are strategically signs, as well as other functions of the company (the problem of coordination and competence at the macro level).
- **Insufficient speed of adoption of new trends, methods and techniques in marketing** - taking into account the above-mentioned facts, and the economic crisis which in the early nineties affected the local economy, it is evident that even the companies that are really marketing behavior, lack space, strength to accept all of the latest trends in marketing (Djordjevic et al, 2001).

### **THE APPLICATION OF CONTEMPORARY METHODS AND TECHNIQUES OF MANAGEMENT IN THE ROLE OF THE IMPROVEMENT OF BUSINESS QUALITY**

Most domestic companies are insufficiently competitive on global competitive market. This is true for most of the companies that come from countries in transition. In order to reach conclusions about the need to apply modern methods and techniques of management in the process of upgrading domestic enterprises a research was conducted. The study involved the analysis of expert opinion leaders and organizations (projected at 50 sample units) in connection with the above defined problem and was carried out from January to June in 2012 on the territory of Serbia, in order to obtain the opinion of enterprise managers on the application of modern management methods and techniques in domestic business organizations.

A large number of respondents, 66.7%, believe that the organization in which they work can be described as an organization that applies modern methods and techniques of management, while 33.3% think the opposite. Among the respondents who feel that their organization uses modern methods and techniques agreement, majority of them, 42.9% mentioned methods and techniques of strategic planning, 23.6% marketing information system, 14.2% the development of innovative activities, human resource management, 4.7% time management, cost management of resources 4.7% [4]. Respondents rated the organizations in which they work in relation to the technological level of the organization and the level of competitiveness of the organization. Results are given in Tables 1 and 2.

**Table 1.** Review of the technological level of the organization

<b>Rank</b>	<b>Rating technological level</b>	<b>Participation in responses</b>
1.	Satisfactory	60%
2.	High	24%
3.	Average	16%

**Table 2.** Evaluation of the level of competitiveness of the organization

<b>Rank</b>	<b>Rating competitiveness level</b>	<b>Participation in responses</b>
1.	Satisfactory	60%
2.	High	20%
3.	Average	20%

As the main factors to improve the business leaders as analyzed emphasize the following: training employees - 21.3%, increase in business productivity - 17.7%, improving the IT basis of business - 17.7%, improving the quality of operations - 13.5%, the internationalization of domestic companies - 9.9%. In the basis of the development of local business organizations are the following elements: investing in employees - 22.4%, investment in equipment and technology - 18.8% investment in the development of new products and services - 17.3% investment in staff training - 12.6% investment in the administrative office building - 11, 9 %. The necessary elements for the development of competitiveness of domestic business organizations are: improving business productivity - 21.3%, permanent training of management and employees - 18.4% investment in the development of national brands - 15, 4 development of an entrepreneurial culture in business - 14 7 %, creating strategic alliances - 9.6%. As the main obstacles in the development of the competitiveness of domestic enterprises can be seen as follows: lack of financial capital - 20%, lack of knowledge - 18.6% , outdated equipment and technology - 15.9% , not enough incentive business environment - 13.1% , inadequate use of modern methods and techniques of management - 12.4%.

According to research results, methods and management techniques to be used in domestic business organization are:

- Database Management 18.4%
- Quality Management System - 17.6%
- Corporate Social Responsibility - 17.6%
- Relationship Marketing - 16.8% and
- Benchmarking - 12.6%.

The need to apply these management techniques, according to the managers of local companies analyzed, substantially coincides with the generally accepted theoretical views on the restructuring of the business functions of the contemporary organization and giving special strategic significance to functions of marketing, quality and research and development. The primary purposes of managing any business function, especially those features that are related to the strategy of the enterprise is the information. The quality management system is a fundamental tenet of integrated building management system - quality is the basis of competitive ability of each organization. Quality and productivity are interconnected - when quality is improved the productivity is improved as well. Corporate social responsibility has become an imperative of modern business because it takes into account the requirements of stakeholders and incorporates them into the business policy of the

company. Modern corporations must be responsive corporations. Benchmarking is essential for continuous analysis of the competitive position of the Organization. Most of the respondents, 75%, stated that their organization has implemented a quality management system according to the requirements of the international standard series ISO 9000<sup>th</sup>. Among the organizations that have introduced quality management system according to the requirements of international standard series ISO 9000, only 30.4% developed an integrated management system. These data fully reflect the state of the local companies that are financially and resource-weak and that have neither the means nor the power to develop quality and integrated management systems as a prerequisite to achieve business excellence. On the other hand, the greatest number of managers, 66 %, according to the domestic market, there are local organizations that can be characterized as a business executive, referring to the likely importance of these organizations in the national and regional frameworks, but not the global frames. If we considered the global market, we may not be able to find companies that would be characterized as a business executive organizations.

## CONCLUSION

Contemporary organizations of today need entrepreneurial management rather than technology itself. However, rapid technological development demands of modern organizations to improve the efficiency of knowledge, innovate and its technological base. This is mainly referred as to high technology in modern business, especially information technology, as a prerequisite for successful business and achieving business excellence. Higher level of technology allows companies to use the opportunities that are in the enterprise environment and directly affects the improvement in labor productivity, and therefore the business.

Methods and techniques of management that local leaders have seen as necessary for successful business in the present research are based on knowledge. New management paradigm on a global scale is based on the process of improving the efficiency of knowledge. Database management is ultimately based on the production and storage of information for management decisions and information is knowledge in the flow. Relationship marketing ultimately involves knowledge management Marketing is a key tool that makes knowledge productive. Benchmarking involves the technique of learning from others' experiences, primarily those best ones. The quality management system originally has a need for continuous improvement in productivity of knowledge mostly through quality education. The concept of corporate social responsibility involves learning about the needs and demands of other stakeholders in the business environment. The question of the application and development of modern management techniques which are given in the model is the issue of achieving, maintaining and improving the competitiveness of domestic enterprises.

## REFERENCES

- [1] Adžes I. (2009). Kako upravljati u vreme krize, Asee, Novi Sad.
- [2] Atali Ž. (2010). Kratka istorija budućnosti, Arhipelag, Beograd.
- [3] Bešić C., Đorđević D., (2007). Benčmarking, Tehnički fakultet, Čačak.
- [4] Bešić C., Krmjević-Mišković Z., Đorđević D. (2013). The role of knowledge in the development process of competitive ability of domestic companies on the global market, III International Conference LEMiMA 2013. 18-20 april, Belgrade, FSOM; FORKUP, Beograd, pp. 214-220.
- [5] Đorđević D., Čočkalo D., Bogetić S., Bešić C. (2012). Razvoj poslovne izvrsnosti i konkurentnost domaćih preduzeća, Međunarodna konvecija JUSK 2012, Zbornik radova, JUSK, Beograd, str. 197-202.

## **SESSION 10: Process Management and Energy Efficiency**

## APPLICATION OF SENSITIVITY ANALYSIS IN PRE-MEASUREMENT PHASE OF BUILDING ENERGY MODEL CALIBRATION

Marko Ignjatović, Bratislav Blagojević, Branislav Stojanović

University of Niš, Faculty of Mechanical Engineering in Niš, Niš, Serbia

e-mail: [marko.ignjatovic@masfak.ni.ac.rs](mailto:marko.ignjatovic@masfak.ni.ac.rs)

**Abstract:** Energy modeling and simulation of buildings, both existing and new, takes significant part in HVAC field and whole building sector in order to achieve defined goals for reducing GHG emissions and energy use. The main reason for ever increasing usage of building simulations is the fact that it is the least harmful way to check the design ideas or refurbishment measures prior to construction. In refurbishment projects, it is not enough just to model the building and its systems. Simulation results obtained for actual weather data at the building location and building usage patterns should be compared with available utility data (energy consumption or cost) collected for given period of time. The process of reducing differences between simulation outputs and measured values is called building energy model calibration. Since the calibration process encompasses building energy audit in most general form and site measurements, there is a need to identify parameters in the model which influence the simulation results the most, and which should be the first ones to measure. One of the ways to identify most influential parameters is to perform sensitivity analysis. In this paper Monte-Carlo analysis, which is one of most widely used global sensitivity techniques with 51 input parameters is performed for existing commercial building of Feniks BB Company. For output only natural gas consumption was selected and as indicator SRRC-standardized regression rank coefficient was selected. Obtained results show that the most sensitive parameters are infiltration schedule fraction and zone infiltration air flow rate, indoor temperature of heavy manufacturing hall and ground temperature.

**Keywords:** building energy modeling; model calibration; sensitivity analysis; EnergyPlus; Simlab

### INTRODUCTION

Over the last 30 years simulation tools have been used to analyze thermal behavior, energy consumption and HVAC system performance of buildings. With ever increasing power of computers and their low cost, computer models were able to help designers in improving building energy efficiency and to check how various design options influence building energy consumption and more importantly thermal comfort within occupied zones. The use of building energy modeling software's like EnergyPlus [1] for example is the best way to check design ideas related to building energy use in every stage of the design (architectural, material selection, HVAC and lighting installations etc.) before the building is even being built. This approach is far more economically viable, although expensive due to the knowledge and effort required to conduct such numerical experiments, then to build the building and then to see there were poor judgments in the design. In refurbishment projects, all potential measures for improving energy efficiency, have to be checked against the real building. Creating building energy model itself is not enough. The real building has to be represented by its virtual "twin" - calibrated building energy model. By calibrated model, it is meant that model mimics the real building and its energy flows as closely as possible. Term "as closely as possible" shows that simulation outputs (i.e. energy consumption, HVAC system performance, indoor air temperatures etc.) match within predefined tolerances [2, 3, and 4] these same parameters which are being measured in the same time resolution (hourly, monthly or annual). The process of reducing differences between measured building energy consumption and simulated one is called calibration [5]. Sensitivity analysis plays an important role in finding parameters that influence building energy consumption or other preferred output the most.

### BUILDING ENERGY MODEL CALIBRATION AND SENSITIVITY ANALYSIS

Calibration is the vital part for improving energy efficiency during operational stage of building life cycle because when models are determined to be calibrated, they can be further used to: analyze energy use in building; identify possible energy efficiency measures; provide support for investments

in energy efficiency measures; provide baseline for comparison of energy efficiency measures and all their effects. The main question is when the model is considered as “calibrated” (acceptance criteria). Common approach is to use utility bills for at least one year (electricity and fuel consumption), typically at monthly intervals, as the benchmark for comparison between model and real building. Two parameters need to be calculated in order to compare the utility bills (energy consumption measurements) and model outputs: Mean Bias Error – MBE, and Cumulative Variation of Root Mean Squared Error – CV(RMSE). In calibrated simulation these parameters need to be calculated at hourly resolution, so it means that the conducted measurements of energy consumption or related physical parameters should be at least measured in the same resolution. In order to reduce number of parameters that should be measured and double checked sensitivity analysis is performed.

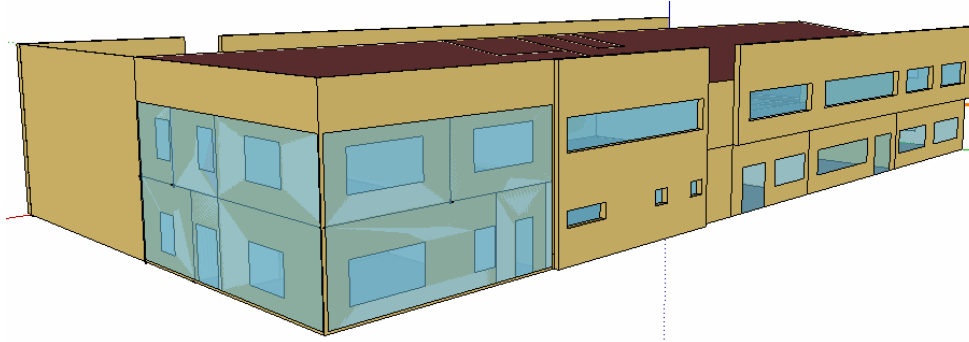
Sensitivity analysis determines the contribution of individual parameter to the model output. There are three common types of methods that are used to conduct sensitivity analysis, the screening, local and global methods, which can all be applied by using building thermal analysis programs. The screening method is necessary in various models that require a large number of input parameters. The main objective is to create a short list of important factors for further analysis. It is applied before global sensitivity analysis to save time. Local sensitivity analysis evaluates the output variability by changing one design parameter while all others are kept constant. This method can be easily compared to global sensitivity analysis. Global sensitivity analysis investigates the effects of all the inputs at once. In other words, it can be used to quantify the influence of uncertain input parameters on the response variability of a model. Usually, Monte Carlo analysis (MCA), which is one of the current global sensitivity analysis techniques, is used because the sensitivity of selected parameters can change based on the interactions and effects of all parameters. Input values should be randomly sampled with their respective probability distribution function. The accuracy of the analysis strongly depends on the sampling technique that must ensure a good coverage of the input space. The Latin hypercube sampling technique covers better the input space than random sampling. The methodology for sensitivity analysis could be described by following steps [6]:

- determine variations (probability distributions) of input parameters with ranges or statistical parameters (mean value, standard deviation)
- create building energy models based on input variations
- collect simulation results
- run sensitivity analysis
- presentation of sensitivity analysis results

The first step in SA is to determine the range of the inputs. For global SA, probability distributions and ranges need to be defined in order to create input parameter sample [7]. Distribution of inputs depends on the research purpose. For example in the design phase wall U-value could be treated as uniform distribution in a given range since all values are equally probable, but in model calibration wall U-value could be treated as normal distribution since wall materials and their properties are known and are likely to be around initial value. For most of global SA it is necessary to do sampling in order to generate sample of input parameters. The second step is the most time consuming because large number of simulations has to be performed. For this step any dynamical simulation software can be used. Third step includes both collecting simulation results and pre-processing them for sensitivity analysis. Fourth step is sensitivity analysis. Based on selected method appropriate software for calculating sensitivity indicators is used. Numerous software are available for this purpose like: *Simlab* 2.2 [8], *R* [9] etc. The final step is post-processing and visualization of results. Results could be presented both graphically and in tables. Selection of chart type depends on number of inputs and outputs and can be fairly simple like bar graphs (for one output) or very complex (Tornado plot, Cobweb plots etc.).

### CASE STUDY - FBB BUILDING

For this research Feniks BB Company building was selected (figure 1). This building represents combination of office and manufacturing (production) building (this type of building is very common in Serbia).



**Figure 1:** Building model created with Open Studio Plug-in for Google SketchUp

Selected building represents combination of office and manufacturing (production) building (this type of building is very common in Serbia) of Feniks BB company. The building is located on the outskirts of City of Niš, Serbia. The building has 1630m<sup>2</sup> of useful floor area. One part of the building (approximately half in volume) is a manufacturing hall, while the other part is divided in two stories where light manufacturing, servicing facilities and offices are located. Most of the outside windows and doors are double glazed with low emission glass. Windows and doors account for 35% of the building façade. In one part north-east and south-east façade of the building are realized with semi-structural glass façade, as shown in figures 3 and 4. All glass fields are double glazed 6-15-4 with green stop-sol outside glass layer. Outside walls are masonry with insulation and aluminum panels (except north-west wall).

On a zone level heating system consists of baseboard heaters (radiators) which heat most of the building premises, air heaters (for heavy manufacturing premises), and ducted fan-coil unit (serving the dining room). Operating regime of all these secondary systems is 65/45°C. In EnergyPlus air heaters and fan-coils are modeled as a combination of their base components: heating coil, fan and mixing section (only for fan-coils).

On a plant level, heat is produced by gas-fired condensing boilers. Boiler with nominal capacity of 92kW is used for space heating. Boiler with characteristics (efficiency curve) provided by boiler manufacturer is modeled.

Electricity and natural gas are being used in the building, and utility bills are available.

For this research, whole building energy simulation program *EnergyPlus* was used. Building geometry was created using *Open Studio Plug-in for Google SketchUp*, as shown in figure 1. All rooms in the building are treated as separate thermal zones.

For simulations, weather file in TMY format for City of Niš was used. In addition, since outside condition measurements (dry bulb temperature, relative humidity, barometric pressure, wind speed and direction) are planned, weather file was modified for the simulation period which is identical to the measuring period of gas consumption (October 15<sup>th</sup> 2012 - March 31<sup>st</sup> 2013.). Weather data for 2012-2013 were taken from free "Weather Underground" database [10], although weather conditions (including solar radiation) should have been taken from local hydro-metrological station. This form of weather file modification is planned for further research.

## SENSITIVITY ANALYSIS

Since this research deals with the existing building, and since HVAC systems are used only for heating, natural gas consumption is only reasonable simulation output for calibration process. Sensitivity analysis will focus on how various input parameters affect simulated gas consumption (output - only virtual meter in EnergyPlus simulation file is for natural gas consumption during heating season). For the research we selected Monte-Carlo Analysis (MCA) with Latin hypercube sampling (LHS), and as sensitivity indicator selected SRRC was selected.

### Input variations - input uncertainties

In literature covering sensitivity analysis numerous probability distribution functions are applied in order to generate input sample. Number of input parameters to be treated ranges from several dozen up



to several thousands [11-15]. For this research input parameters, their probability distribution functions and ranges are given in table 1. For physical properties normal distribution has been selected with mean values as in [16] and standard deviation equal to 10% or 20% of the mean value. For all other parameters uniform distribution has been selected.

**Table 1.** Input parameters with probability distribution function and ranges

<b>Input parameter</b>	<b>Probability function</b>	<b>Range/mean value and standard deviation</b>
Ground temperature, °C	Uniform	3 - 16
Infiltration schedule	Uniform	0 - 1
Indoor temperature: Offices	Normal	$\mu=22, \sigma=2$
Electronic department		$\mu=20, \sigma=2$
Light manufacturing		$\mu=18, \sigma=2$
Heavy manufacturing		$\mu=18, \sigma=2$
Hot water supply temperature, °C	Normal	$\mu=65, \sigma=5$
Lime cement mortar: thickness, m	Normal	$\mu=0.015, \sigma=0.0015$
conductivity, W/mK		$\mu=0.99, \sigma=0.099$
density, kg/m <sup>3</sup>		$\mu=1900, \sigma=190$
specific heat, J/kgK		$\mu=1050, \sigma=105$
Cement mortar: thickness, m	Normal	$\mu=0.02, \sigma=0.002$
conductivity, W/mK		$\mu=1.4, \sigma=0.14$
density, kg/m <sup>3</sup>		$\mu=2100, \sigma=210$
specific heat, J/kgK		$\mu=1050, \sigma=105$
Brick clay: conductivity, W/mK	Normal	$\mu=0.61, \sigma=0.061$
density, kg/m <sup>3</sup>		$\mu=1400, \sigma=140$
specific heat, J/kgK		$\mu=920, \sigma=92$
Brick: conductivity, W/mK	Normal	$\mu=0.64, \sigma=0.064$
density, kg/m <sup>3</sup>		$\mu=1600, \sigma=160$
specific heat, J/kgK		$\mu=920, \sigma=92$
Cast concrete 20: thickness, m	Normal	$\mu=0.20, \sigma=0.02$
conductivity, W/mK		$\mu=2.04, \sigma=0.204$
density, kg/m <sup>3</sup>		$\mu=2400, \sigma=240$
specific heat, J/kgK		$\mu=960, \sigma=96$
Cast concrete 15: thickness, m	Normal	$\mu=0.15, \sigma=0.015$
conductivity, W/mK		$\mu=2.04, \sigma=0.204$
density, kg/m <sup>3</sup>		$\mu=2400, \sigma=240$
specific heat, J/kgK		$\mu=960, \sigma=96$
Concrete block 20: thickness, m	Normal	$\mu=0.25, \sigma=0.025$
conductivity, W/mK		$\mu=2.33, \sigma=0.233$
density, kg/m <sup>3</sup>		$\mu=2500, \sigma=250$
specific heat, J/kgK		$\mu=960, \sigma=96$
Cast concrete 30: thickness, m	Normal	$\mu=0.30, \sigma=0.03$
conductivity, W/mK		$\mu=2.04, \sigma=0.204$
density, kg/m <sup>3</sup>		$\mu=2400, \sigma=240$
specific heat, J/kgK		$\mu=960, \sigma=96$
<sup>a</sup> Window#1: U-value, W/m <sup>2</sup> K	Normal	$\mu=5.68, \sigma=1.136$
SHGC, -		$\mu=0.766, \sigma=0.0766$
<sup>b</sup> Window#2: U-value, W/m <sup>2</sup> K	Normal	$\mu=3.28, \sigma=0.656$
SHGC, -		$\mu=0.687, \sigma=0.0687$
<sup>c</sup> Window#3: U-value, W/m <sup>2</sup> K	Normal	$\mu=2.55, \sigma=0.51$
SHGC, -		$\mu=0.195, \sigma=0.0195$
<sup>d</sup> Window#4: U-value, W/m <sup>2</sup> K	Normal	$\mu=2.631, \sigma=0.5262$
SHGC, -		$\mu=0.499, \sigma=0.0499$
<sup>e</sup> Window#5: U-value, W/m <sup>2</sup> K	Normal	$\mu=2.497, \sigma=0.4994$
SHGC, -		$\mu=0.387, \sigma=0.0387$
<sup>f</sup> Door: U-value, W/m <sup>2</sup> K	Normal	$\mu=4, \sigma=0.8$
SHGC, -		$\mu=0.9, \sigma=0.09$
Zone infiltration, ACH	Uniform	0.2 - 1.5
Boiler Efficiency	Uniform	0.85-0.95

*Note:* window composition is as follows: a) 4mm single clear glass; b) 4-12-4 double clear filled with air; c) 6-15-4 with green stopsol glass filled with air; d) 6-15-4 with lowE glass filled with air; e) 4-12-4 with lowE glass filled with air; f) steel door

### Sample generation and simulations

For this research MCA global sensitivity analysis with Latin hypercube sampling (LHS) was performed in *Simlab* 2.2 software which enables defining input parameters from table 1 and Latin hypercube sampling, amongst the other features. Requirement is that sample size is at least 1.5 times higher than the number of parameters [8]. Since 51 parameters were selected, total of 100 samples was generated. After the sample was created, parametric pre-processor feature of *EnergyPlus* was used to run simulations, for both TMY weather file and for the 2012-2013 weather file.

### Results and discussion

SRRC as sensitivity indicator was calculated in *Simlab* 2.2. Figure 2 present the sensitivity of each of the building parameters. A positive SRRC means that as the value of the building parameter increase, the value of the corresponding output simultaneously increases. A negative SRRC implies that changes in the inputs and outputs tend to go in opposite directions. There is no considerable difference in the order of building parameters for two weather files selected. Parameters that have the greatest influence on gas consumption in the absolute order are: infiltration schedule, zone infiltration ACH, indoor temperature in heavy manufacturing premises and ground temperature.

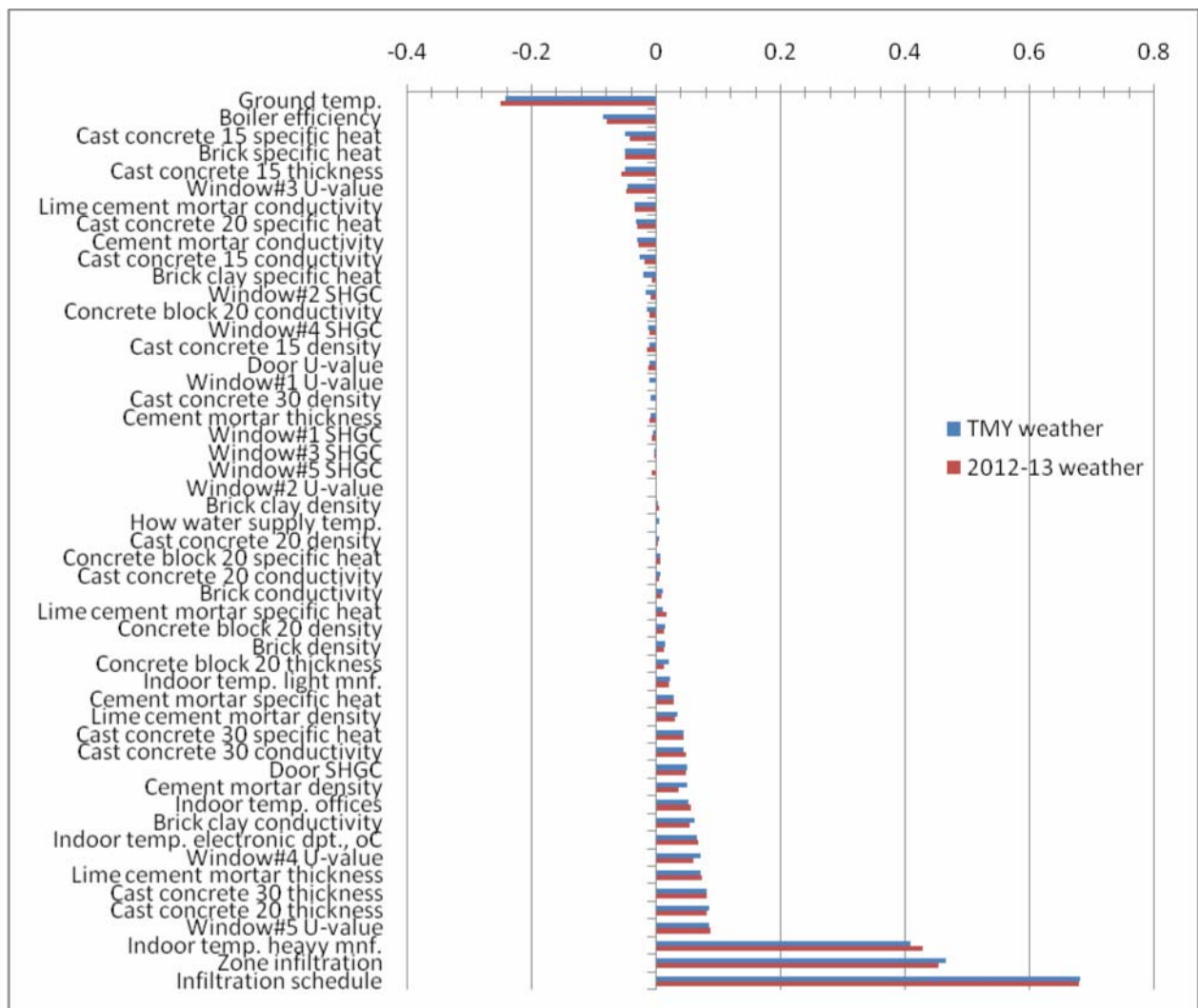


Figure 2. SRRC for TMY and 2012-13 weather files

## CONCLUSION

This study showed that for calibration, sensitivity analysis can point out which parameters need closer attention and if it is possible what measurements should be taken. In our case indoor temperature measurements are the easiest to implement since the measuring equipment and acquisition system are available through existing building BMS, although additional indoor temperature sensors will be placed. Measuring ground temperature has "mid level difficulty", and it is unlikely to implement but with available literature this obstacle can be passed. The main problem will be to describe infiltration in the model. In the absence of blower-door test, detailed numerical models for infiltration must be used.

## Acknowledgement

This paper was done within the framework of the project TR 33051-”The concept of sustainable energy supply of settlements with energy efficient buildings” (2011-2014), financed by the Republic of Serbia Ministry of Education and Science.

## REFERENCES

- [1] DOE. EnergyPlus V7.2, October 2012, Department of Energy, USA. 2012
- [2] Efficiency Valuation Organization, International Performance Measurement and Verification Protocol: Concepts and Options for Determining Energy and Water Savings, Vol I, 2012.
- [3] ASHRAE, ASHRAE Guideline 14-2002: Measurement of Energy and Demand Savings, American Society of Heating, Refrigerating and Air-conditioning Engineers, USA, 2002.
- [4] DOE, M&V Guidelines: Measurement and Verification for Federal Energy Projects, Version 3.0, US Department of Energy, 2008.
- [5] Reddy, T., Literature Review on Calibration of Building Energy Simulation Programs: Uses, Problems, Procedures, Uncertainty, and Tools, ASHRAE Transaction, Vol.112, Part I, ASHRAE, 2005.
- [6] Tian, W., A review of sensitivity analysis methods in building energy analysis, Renewable and Sustainable Energy Reviews Vol.20, pp. 411-419, 2013.
- [7] Macdonald, I., Comparison of sampling techniques on the performance of Monte-Carlo based sensitivity analysis, Proceedings of International Building Performance Simulation Association, vol.11, pp. 992-999, 2009.
- [8] SIMLAB. V2.2, Simulation environment for uncertainty and sensitivity analysis. Developed by the Joint Research Center of the European Commission. 2011.
- [9] R development core team. R: a language and environment for statistical computing. R foundation for statistical computing, Vienna, Austria. ISBN 3-900051-07-0, URL <http://www.R-project.org/S>. 2011.
- [10]<http://serbian.wunderground.com/history/airport/LYNI/2013/10/01/DailyHistory.html>
- [11] Heiselberg, P., et al, Application of sensitivity analysis in design of sustainable buildings, Renewable Energy, vol.34, pp. 2030-2036, 2009.
- [12] Hopfe, C., Hensen, J., Uncertainty analysis in building performance simulation for design support, Energy and Buildings, vol.43, pp. 2798-2805, 2011.
- [13] Rodriguez, G., et al, Uncertainties and sensitivity analysis in building energy simulation using macroparameters, Energy and Buildings, vol.67, pp. 79-87, 2013.
- [14] Eisenhower, B. et al, Uncertainty and Sensitivity Decomposition of Building Energy Models, Journal of Building Performance Simulation, vol.5(3), pp. 171-184, 2012.
- [15] Yildiz, Y., Arsan, Z., Identification of the building parameters that influence heating and cooling energy loads for apartment buildings in hot-humid climates, Energy, vol.(36), pp. 4287-4296, 2011.
- [16]\*\*\*, Republic of Serbia Ministry of Environment, Mining and Spatial Planning, Ordinance on Energy Efficiency of Buildings, Official Journal of the Republic of Serbia (in Serbian), 61/2011

## ENERGY INTEGRATION OF NITRIC ACID SYNTHESIS PROCESS USING HINT

Sofija Miškov<sup>1</sup>, Gorica Ivaniš<sup>2</sup>, Marija Lazarević<sup>3</sup>, Ivona Radović<sup>2</sup>, Mirjana Kiječčanin<sup>2</sup>

<sup>1</sup>Maharakham University, Faculty of Science, Thailand

<sup>2</sup>University of Belgrade, Faculty of Technology and Metallurgy, Serbia

<sup>3</sup>Galenika Fitofarmacija, Serbia

e-mail: mirjana@tmf.bg.ac.rs

**Abstract:** The heat exchangers network that is used in production of nitric acid is analysed by applying the pinch method and comparing with literature data. Together, solutions share similarities. Designed new energy grid gave good results with new order of heat exchangers. Also, "pinch" method gave good results from economic aspect, what is a confirmation that it gives better energy integration, in comparison with literature.

**Key words:** "Pinch" method, energy optimisation, energy integration, nitric acid production, total costs

### INTRODUCTION

The heat exchangers, heaters and refrigerators, along with the currents that connect them or that pass through them, form a network of heat exchangers. Network of heat exchangers along with utilities represent the most appropriate part of the technological systems through which process costs can be reduced by optimization of certain parameters. In this work, comparison of the solution from literature and new solution are given on the example of nitric acid production in the plant Petrochemical Industry-Kutina, located in Croatia [1,2]. Synthesis of heat exchanger networks i.e. energy integration of process allows significant reduction in energy requirements [3-6]. Therefore, the methods for obtaining the most suitable arrangement of heat exchangers are developed. One of the latest is "pinch" method, by which one can easily perform process optimization and thus better and more efficient energy use. "Pinch" technology is very suitable for a detailed energy analysis of the process, but also for comparison of alternative networks in the relatively short time [7-15].

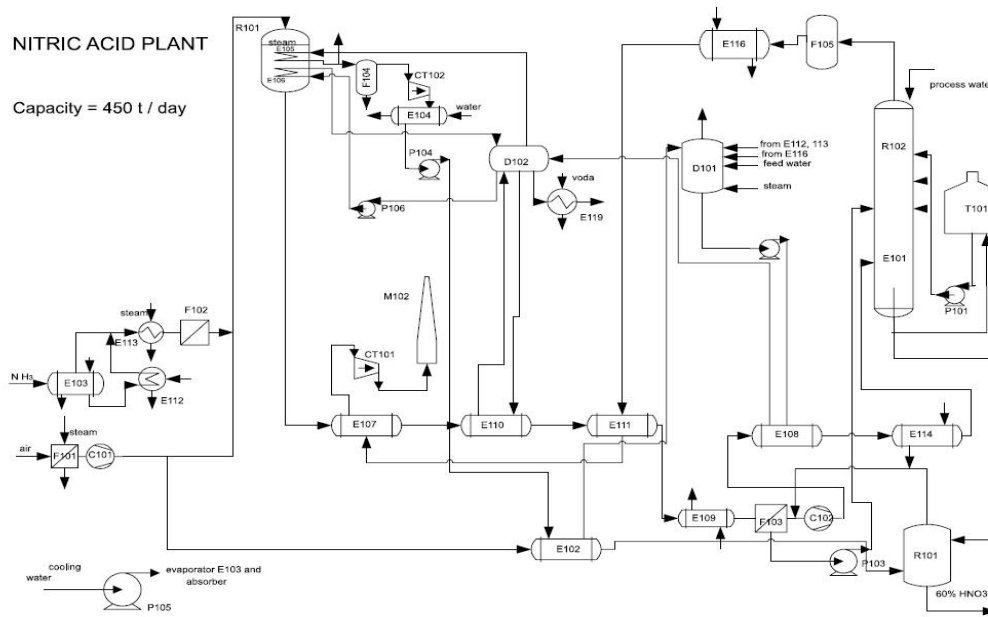
### MATERIAL AND METHODS

Software package HINT [16] is used to design heat exchangers network in this work. At the beginning of the work it is necessary to enter data such as: temperature (input and output), water equivalent (CP) of every stream, enthalpy (H) and  $\Delta T_{\min}$ . Possible alternatives to the network of heat exchangers can be considered from obtained grid diagram. Composite curves of warm and cold currents also can be analyzed, as well as total composite curve.

This process includes 17 heat exchangers, 2 turbines (steam and gases), 2 compressors, 3 filters, 2 flash vessels and 3 reactors. The high pressure steam generated by heat transfer is utilized for other process in Petrochemical Industry. The power generated on turbine is used for compressor work. The energy of medium pressure steam (12.2 bar), low pressure steam (4.4 bar), cooling water and boiler feed water is consumption for 16 streams. Figure 1 shows the process flowsheet where pinch methods are outlined [1].

Liquid ammonia is introduced into the evaporator where it is converted to gaseous state by the indirect heating with steam (E103, E112 and E113). Gaseous ammonia is further passed through a filter (F102) to remove drops or impurities. In this way the gas stream of pressure about 8 atm is produced without mechanical compression. The air is compressed (C101) to the same pressure and heated to a temperature of 200-300 °C. It is also purified in the filter (F101) before mixing with ammonia. Gaseous mixture containing about 10% of ammonia is prepared immediately before conversion and introduced into reactor (R101) where it is converted over a hot catalyst (850-930 °C) consisting of multiple layers of platinum-rhodium network.

E – heat exchanger      T – tank  
 CT – turbine            R – reactor  
 D – drum                P – pump  
 C – compressor        F – flash vessel



**Figure 1** The process flowsheet of nitric acid synthesis plant

The product of the catalytic oxidation of ammonia is hot gaseous mixture consisting of NO, steam and no reacted components of air, nitrogen and oxygen. Yield response to a pressure of 8 atm is 95%, while at atmospheric pressure reaches 97-98%. The resulting gaseous mixture is cooled in heat exchangers (E107, E110 and E111) and the released energy is used to produce steam that is used for heating ammonia and air at the beginning of process. Cooling the mixture to moderate temperature allows regeneration of the catalyst, which is an important process taking into account the price of platinum.

After catalyst regeneration gas blend is rapidly cooled further in the condenser (E109) to a temperature of 50 °C. Absorption of nitrogen oxides in the water leads to the formation of diluted nitric acid whose concentration is 2-30% and it is introduced to the top of the absorption tower (R102). The cooled gaseous blend which still contains NO, NO<sub>2</sub>, N<sub>2</sub>O<sub>4</sub> and a part of non reacted N<sub>2</sub> and O<sub>2</sub> from air is introduced into the lower part of the absorption tower. In the absorption tower the rest of NO is oxidized to NO<sub>2</sub> and N<sub>2</sub>O<sub>4</sub> with the simultaneous absorption of NO<sub>2</sub> in water, which is also introduced into absorption tower. In order to complete the oxidation of NO an additional quantity of air is brought. If the absorption process is performed at atmospheric pressure concentration of obtained nitric acid is 45-50%, while at high pressure acid concentration reaches up to 70% [17-19].

With the process flowsheet of nitric acid plant and the corresponding material and energy balances it is possible to form a data table with all the necessary parameters for each process stream that is involved in the energy integration [2].

## RESULTS AND DISCUSSION

The solution of authors Matijašević and Otmačić [1] is firstly shown as result of power network synthesis.

Energy cascade is formed for all considered process streams and the proposed value of  $\Delta T_{\min}=38$  °C. With the help of heat or energy cascade, which shows the heat transfer between the intervals, minimum requirements for heating and cooling can be established:

- Minimum process requirements for heating amounts  $Q_{H,\min}=0.48$  kW, which is very small so in this case it can be ignored
- Minimum process requirements for cooling amounts  $Q_{C,\min}=25114.7$  kW
- Corrected "pinch" temperature is 277 °C

After increasing the temperature of the hot streams of the value  $\Delta T_{min}/2 = 19^\circ\text{C}$  and reducing the temperature of the cold streams of the same value, the "pinch" temperature of hot streams is  $T_{p,H}=296^\circ\text{C}$  and the "pinch" temperature of cold streams is  $T_{p,C}=258^\circ\text{C}$ .

Next step is designing heat exchangers network. Process contains 17 devices, 9 heat exchangers and 8 coolers. As mentioned earlier, process does not require additional heating so in grid diagram shown in Figure 2 there is no heaters.

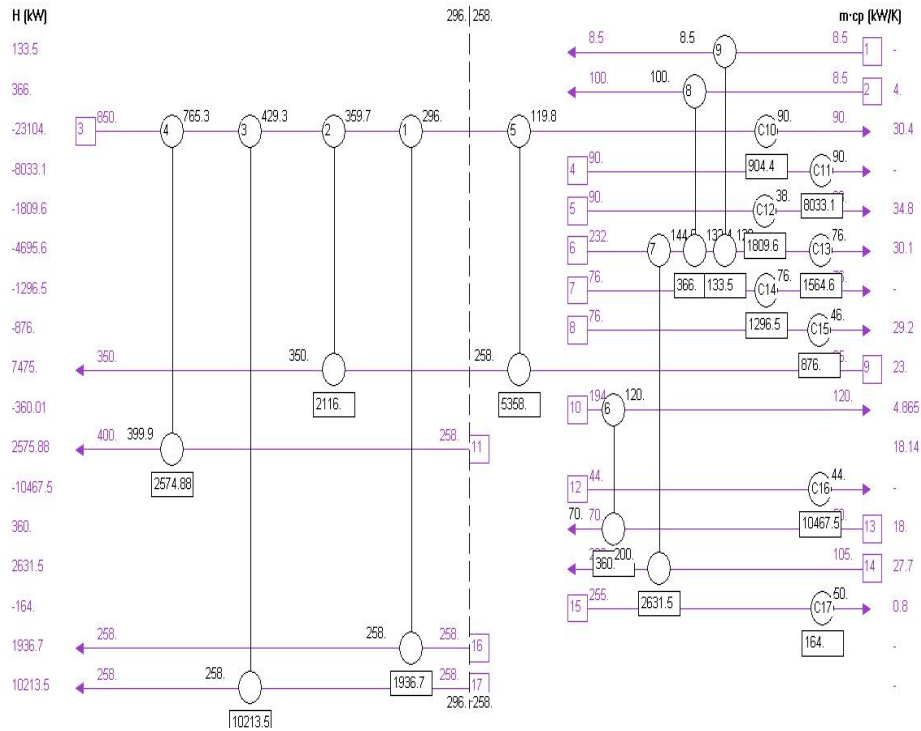


Figure 2 Grid diagram of nitric acid production process given by authors [7]

It is important to note some corrections that are made to get shown heat exchangers and coolers network.

1. Water equivalent is adjusted from  $CP=18.2$  to  $CP=18.14$ . As a consequence, enthalpy of this stream is reduced from 2584.4 kW to 2575.88 kW. Additional heating of stream 11 is reduced by this correction for the value of 9.2 kW. Program accepted this solution although the final temperature of stream 11 is  $399.9^\circ\text{C}$  instead of  $400^\circ\text{C}$ . Hence, there is minimal demand for heating process from 0.48 kW, which have been neglected.

2. Water equivalent of stream 10 is corrected from  $CP=4.8$  to  $CP=4.865$ . In this way enthalpy of streams 10 and 14 (in the Fig. 2 it is marked as stream 13 because "real" stream 13 is divided into two streams 16 and 17) are equalled and they are efficiently resolved by linking through exchanger number 6 with capacity of 360 kW. An important note is that exchanger 7, which connects streams 6 and 15 has smaller temperature difference between hot and cold stream than recommended value  $\Delta T_{min}=38^\circ\text{C}$ . Minimum temperature difference for exchanger 7 is  $32^\circ\text{C}$  [2].

Based on the analysis of the given network it can be seen that exchanger 5 (connecting streams 3 and 9) transfers heat through "pinch" point.

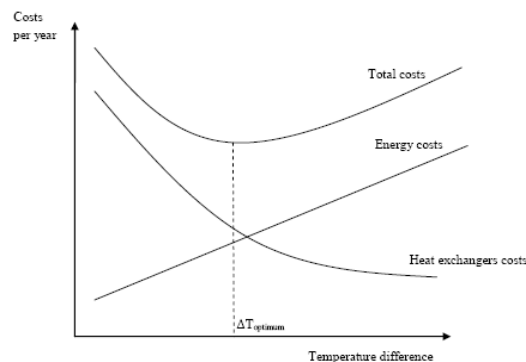
In the program report, there is also analysis of existing solution. As the part of this analysis the number of set devices, their sizes, capital costs and heating and cooling demands were presented. From these data costs of heating and cooling can be calculated and also total costs that are equal to the sum of capital and energy costs i.e. costs of heating and cooling can be obtained. Energy costs were calculated using the formula:

$$\text{Total energy costs} = \sum Q_u C_u$$

In the case considered, hot utility requirement (water steam) is 5359.48 kW and this roughly corresponds to the amount of heat that is transmitted through "pinch" e.g. by heat pump. Demand for cooling water as cold utility is 25115.7 kW. Prices of utilities are calculated in dollars per kW annual from data taken from literature [20]. When all the necessary parameters are known, total energy costs can be calculated.

Value of capital costs depends on economic factors such as interest on borrowed capital, payback time, investment factors etc.

If  $\Delta T_{\min}$  increase, less heat is exchanged in system, which means that less surface of heat exchangers is required. With increasing area, capital costs will decrease (if  $c < 1$ ), or, if  $\Delta T_{\min}$  increases then capital costs reduce and slowly tend to zero. Meanwhile, with increasing  $\Delta T_{\min}$  the need for additional devices increases i.e. energy costs increase linearly because if less heat is transmitted in heat exchangers then more external heat is required (using heaters and coolers). When these two types of costs are summed up the total curve of costs is obtained and it has minimum for a certain value of  $\Delta T_{\min}$  (Figure 3). It is best to conduct the process at lowest total costs i.e. at the value  $\Delta T_{\min, \text{opt}}$  which corresponds to that minimum.



**Figure 3** Total costs as a function of  $\Delta T_{\min}$

During the solving this problem real price values of heat exchangers are entered in program using formulas and constants taken from literature [21]. Program itself calculates area of every heat exchanger automatically.

In this way costs, i.e. prices of every heat exchangers in designed network [2], are calculated. Finally, total costs per year of designed plant are calculated by summing total capital costs and total energy costs.

#### *Simulation of new solution*

Another solution which aims to eliminate certain defects that are noticed in first solution from literature is shown below.

Identical value of  $\Delta T_{\min} = 38^\circ\text{C}$  is adopted in this simulation so formed energy cascade is the same. Therefore heating and cooling demands are unchanged. The same corrections of water equivalents of streams 10 and 11 are done in this simulation as in the previous one. Designed network contains 17 devices (9 heat exchangers and 8 coolers). The difference between this and previous solution is that in every heat exchanger of energy network minimal temperature difference of  $38^\circ\text{C}$  is achieved by different schedule, as is shown in Grid diagram (Figure 4). For area above the "pinch", stream connection is similar to the one from previous solution except flow of stream 13 is not divided. For the area under the "pinch" heat exchanger number 4 is the most important and it is firstly set. The only stream that has enough heat to warm stream 15 to  $200^\circ\text{C}$  without disturbing value of  $\Delta T_{\min} = 38^\circ\text{C}$  is stream number 3 and heat exchanger number 4 connects these two streams.

In this way there is not heat transfer through the "pinch" and that is another advantage over original solution.

Total heating demands are 0 and total cooling demands are 27688.3 KW, Noting that constants necessary to calculate the actual costs of the heat exchangers [21] and prices of utilities [20] are identical as in solution from literature [1].

Using specified data next results can be reached:

- There is not heating demands in present process so there are not costs of heating;
- Total energy costs are equal to the costs of process cooling.

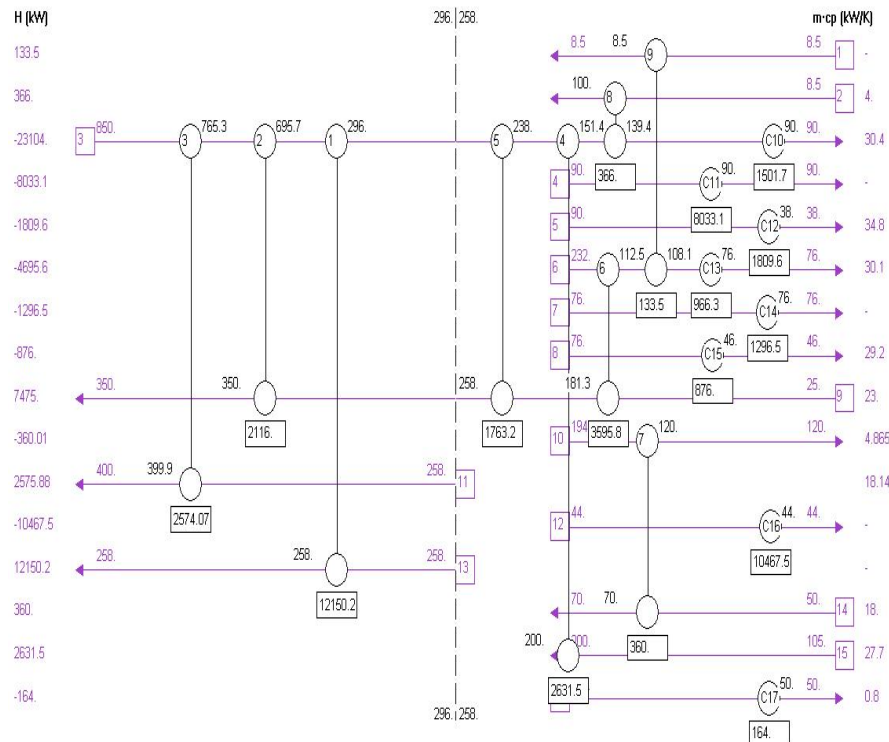


Figure 4 Grid diagram of nitric acid production process

## CONCLUSION

This work shows how using the "pinch" technology reduces process heating and cooling demands. The heat exchangers network, which occurs in the plant for the production of nitric acid, is analyzed by applying "pinch" procedure.

Two solutions are presented in the results: the first solution already existed in the literature [1], while the second is a new simulation of energy grid. Both solutions share many similarities. In both cases the number of installed devices is 17, of which 9 are heat exchangers and 8 are coolers. Identical value of 38 °C is adopted for minimal temperature difference between hot and cold streams. Both energy projected networks do not require additional process heating so no heater is used. Certain approximations and corrections that were made are also identical.

Two the biggest lacks of the first solution are certainly not keeping the minimum temperature difference between hot and cold streams in one heat exchanger and heat transfer through the point of "pinch". In the second solution a different arrangement of heat exchangers is made in order to eliminate those shortcomings.

Designing the energy grid with new schedule of heat exchangers gave good results. All rules of "pinch" technology were taken into account, the minimum temperature difference of 38 °C was held in each heat exchanger and there was not heat transfer through the point of "pinch".

If new solution is looked at from the economic aspect obtained results are satisfactory, too. Annual saving of about 14 % and it is the most striking evidence that using a "pinch" technology and better energy integration of process can achieve significant financial savings for each plant.



## REFERENCES

- [1] Matijašević, Lj., Otmačić, H., Energy recovery by pinch technology, Applied Thermal Engineering, Vol.22, pp.477, 2002.
- [2] Matijašević, Lj., Toplinska analiza procesa - I. Sinteza mreže izmjenjivača topline pinch postupkom, Kem. Ind. Vol.55, 403,2006.
- [3] Sun, L., Luo, X., Comput.Chem. Eng., Vol.35, pp. 1257-1264, 2011.
- [4] Smith, R., Appl. Therm. Eng., Vol.20, pp.1337-1345, 2000.
- [5] Zhu, F. X. X., Vaideeswaran, L., Appl. Therm. Eng., Vol.20, pp.1381-1392, 2000.
- [6] Furman, K. C., Sahinidis, N. V., Ind. Eng. Chem. Res., Vol.41, pp.2335-2370, 2002.
- [7] Kijevčanin, M., Đorđević, B., Očić, O., Crnomarković, M., Marić, M., Šerbanović, S., J. Serb. Chem. Soc., Vol.69, pp.827-837, 2004.
- [8] Domenichini, R., Gallio, M., Lazzaretto, A., Energy, Vol.35, pp.2184-2193, 2010.
- [9] Friedler, F., Appl. Therm. Eng., Vol.30, pp.2270-2280, 2010.
- [10] Fujimoto, S., Yanagida, T., Nakaiwa, M., Tatsumi, H., Minowa, T., Appl. Therm. Eng., Vol.31, pp.3332-3336, 2011.
- [11] Panjeshahi, M. H., Langeroudi, E. G., Tahouni, N., Energy, Vol.33, pp.46-64, 2008.
- [12] Feng, X., Pu, J., Yang, J., Chu, K. H., Appl. Energy, Vol.88, pp.1965-1982, 2011.
- [13] Bengtsson, C., Nordman, R., Bemtsson T., Appl. Therm. Eng., Vol.22, pp.1069-1081, 2002.
- [14] De Monte, M., Padoano, E., Pozzetto, D., Appl. Therm. Eng., Vol.23, pp.1033-1044, 2003.
- [15] Rašković, P., Stoiljković, S., Energy, Vol.34, pp.593-612, 2009.
- [16] Martin, A., Mato, F. A., Education for Chem. Eng., Vol.3, pp. e6-e14, 2008.
- [17] <http://www.google.com/#hl=en&biw=1440&bih=649&&sa=X&ei=mfypTLfUKMTDswaIlqPDA&ved=0CBEQBSgA&q=proizvodnja+azotne+kiseline&spell=1>.
- [18] <http://www.epa.gov/ttn/chief/ap42/ch08/final/c08s08.pdf>.
- [19] <http://www.efma.org/documents/file/bat/BAT%20Production%20of%20Nitric%20Acid.pdf>.
- [20] Yoon, S.-G., Lee, J., Park, S., Heat integration analysis for an industrial ethylbenzene plant using pinch analysis, Applied Thermal Engineering, Vol.27, pp.886-893, 2007.
- [21] Towler, G., Sinnott, R., Chemical Engineering Design, Principles, Practice and Economics of Plant and Process Design, Elsevier, London, 2008

## PROJECT PREPARATION ISSUES FOR ERP IMPLEMENTATION IN VERTICALLY INTEGRATED OIL COMPANIES

Aleksandar Stojkov<sup>1</sup>, Eleonora Brtka<sup>2</sup>

<sup>1</sup>"NIS a.d." Novi Sad, Serbia

<sup>2</sup>University of Novi Sad, Technical Faculty "Mihajlo Pupin", Zrenjanin, Serbia

e-mail: [stojkovaleks@gmail.com](mailto:stojkovaleks@gmail.com)

**Abstract:** The paper represents an introduction of changes that large scale ERP implementation project issues for big companies. The implementation shows a modern, integrated information system that aims to improve the effectiveness of Marketing and Logistics in a large vertically integrated oil company. Special consideration is given to the necessary preparations leading to the successful integration of existing business processes to a new information system which manages the logistics processes. Increasing the efficiency of ERP implementation requests the redesign of business processes and changes in the organization of logistics. When top management determines the target internal level, which anticipates a significant increase in the efficiency of logistics processes, project management must deliver a clear message to all the participants in the implementation through selected communication channels.

**Key words:** oil and gas industry, marketing, logistics, communications, ERP implementation

### INTRODUCTION

The global economic crisis and changes of macroeconomic conditions in the countries of South Eastern Europe adversely affect energy consumption, and add more challenges to the market conditions in which production and processing of oil and gas take place. In the dynamic environment there are unexplored areas with potential for exploitation of raw materials and further development of the oil business. However, for most companies in this industry branch basic objectives are not only set in research, processing or distribution but in the streamlining of logistics processes, reduce of inventory and logistics costs. The market leaders in this field are building a competitive advantage based on informations from the advanced information system for efficient data collection and analysis. So creating new quality in management and marketing decisions has been based on timely and accurate data from database of marketing and logistics information system.

### MATERIAL AND METHODS

#### Marketing Logistics and development of ERP system

This paper highlights the changes in the understanding of the importance of marketing and logistics in the business structure of the company. Guided by the idea that corporate governance must be in accordance with customer needs, marketing experts are finding different ways to reach out to customers, using all available elements of the marketing mix. Marketing, using its tools to transfer the sphere of influence of market factors, as well as internally to staff training, thus changing the corporate culture at all levels of the company. Marketing modeling and creating value in the supply chain operational strategic actions have supportive role in the development of products and their accurate delivery to the consumers. Customer service has become an essential element of the marketing mix in all phases of innovation and new product development. Since the preparation of oil and gas production, through transportation, refinery processing and distribution of finished products, the system requires very high level of customer service, as the impact on the business result of the company stands alligned with logistics management. Logistics management is the force that controls the flow of materials through the distribution channel and is a strong support for the basic activities of the company [3].

Through the analysis of the positive and negative influences during the implementation project of a new information system, company management meets changes in various channels (organization, processes, communication channels, etc...). Experiences in projects show that the large-scale changes are time consuming and that the introduction of new IT solution is an expensive investment process,

accompanied by a significant risk of unsuccessful implementation. Great speed of changes in the entire matrix and expected high quality results require extensive preparation for project implementation and the additional dynamic engagement of all participants in the project. After the completion of the overall project, there is always a need for further improvements and new development costs, so that the process of investment in ERP system never stops. Budgeting for future development is not always obvious, unless funds for maintenance of the system perceive in the business requirements for development of existing solutions during adolescence phase. The significance of the new information system for the management of a vertically integrated oil company and achieving standardization process for several organizational units: oil and gas-exploration, refining, trading, etc. All parts of the quoted companies had previously used its own logistical information systems of various development level, and could not emit a consistent and reliable information about logistical changes or provide a perspective for the further development of monitoring of commodities, monetary and financial flows.

### Methodology of implementation

Implementation methodology is one of the first major decisions management needs to focus onto, in the search of effective project implementation.

Although all manufacturers of ERP software can be implementers, there are other, specialized companies that allow the introduction of a new information system. What the customer expects from the ERP system are supported and connected all the basic processes of the methodology that will enable the mastering of new solutions, managing business risks and the transition to a new way of working. In this sense, the definition of strategies is to implement appropriate approach to create positive atmosphere for the public that has a major impact on the success of the project, as well as the selection of ERP solutions.

The strategy is, in large part, determined by the size of the company, the scope of the planned changes and the financial capabilities of the company. Other factors of influence can be further investigated, but basically they are grouped into several types:

- The geographical scope - the company's local, regional, or global view (how the implementation should be different from country to country);
- The needs of the customer - if a particular group of customers needs information that the current system can not provide;
- User needs - which part of the company leads further development and installations (FI, ICT and marketing);
- Time and urgency - if the further development and use of the previous system (Legacy information system) are associated with high costs and too many errors;
- The impact of the previous information system involving ratio of coverage process.

**Big Bang** is an example of frontal implementation popular in the late nineties when the process included the simultaneous introduction of a new ERP system in all modules in all parts of the company. With a limited budget and financially compressed time implementation of this method can achieve fast resulting implementation, at a great risk. Advantages and disadvantages of this type of implementation can be represented as follows [2]:

Advantages:

- Shorter implementation time and lower cost of the project;
- Have the necessary software for data defined in the previous system to the new because of input of all modules into service at the same time;
- Simultaneous high motivation of all the participants in the project;
- High efficiency because it avoids repetition of system adjustments;
- Optimal integration of all components related to the integration of business processes.

Disadvantages:

- Complexity of the higher need for coordination and integration;
- Intensive use of all resources in a short period of time;
- All employees are under high stress at the same time;
- The need for simultaneous work of more consultants;

- Organizational changes must be limited in scope to overcome the effect of simultaneous resistance of employees to the package of introduced changes.

As a side effect of this type of implementation, there is a temporary decline in operating performance of the company for all employees gradually learn about the new way of working and this can not be easily solved without a period of increased number of errors.

**Phased Implementation** involves the gradual implementation of ERP solutions that takes place in a clearly pre-defined stages. This methodological approach is acceptable to the diversified company, first time together in an integrated information system. Phased implementation leads to a gradual change, to a lower risk of failure and less stress for the participants. Phased implementation can be realized in different ways, depending on the needs of the business:

- Implementation of the modules are most commonly used , involves the gradual introduction of basic modules (needed for daily activities) or simple modules that are not critical to operations and subsequent upgrade of complex modules;
- Implementation of the business units starts in one or two functions at the same time developing according to plan, other business units building on their experience, gradually increasing efficiency;
- Implementation of the geographic principle is applicable for companies that are located in several regions and have the independent outlets. In this case, so-called ERP pilot projects can be used in several parts of the company in one location.

Advantages of the concept of phased implementation:

- Lower the complexity of organization, coordination, monitoring costs of the project;
- A small number of key users and reducing the involvement of end-users ;
- The higher the quality of the project as project participants continue improving knowledge;
- Internal consulting team can engage in additional work, reducing project costs;
- Less resistance to changes in the company, as people gradually adapt to changes;
- Project costs are increasing and reprogrammed for a longer period of time;

Disadvantages:

- Longer duration and higher costs of the project;
- To maintain the current system must develop transfer programs (interface) from other systems ;
- Project integration advantage - it can be a step by step ;
- Adjustments must be optimall, as Integrated Systems parameters have not yet been implemented ;
- Return on investment usually late in the plan.

**Parallel implementation** of the strategy and methodology is one of the least spoken. It presents the least risk to the company and includes two processes running in parallel, the previous and the new ERP solution. Such key users can learn to operate the new system while still working on the previous one. After the ERP system parameters are achieved, the previous system stops working. This is a " middle way " between the big bang strategy and a phased approach. The changes are slower than the big bang but faster than a phased approach, so for the user it is easier adaptation than the big bang, and heavier than the phased approach.

The biggest difference is in the cost of implementation for parallel implementation is the most expensive way of implementation. In addition, involvement of users to enter data in both systems are not efficient or recommended process. In any case, these additional costs are lower than the costs incurred by a failed big bang implementation. Companies are not able to recognize the cost overruns that may arise from errors big bang implementation, while the parallel implementation easily recognize the high costs and rarely to this way of ERP implementation.

Advantages of the concept of parallel implementation:

- Low stress employees involved in the implementation;
- The workforce develops together with the new system, anticipating change and new environment;
- A small probability of error due to multiple tests.

Disadvantages:

- Long implementation period and high cost;
- Additional strain and pressure on employees due to parallel operation of the two systems...

According to data gathered by the experts for the implementation of the company's "Software Advice" in April, 2010, for a sample of 45 companies from the U.S., who carried out the actual ERP implementation gave the following information on implementation strategies [4]:

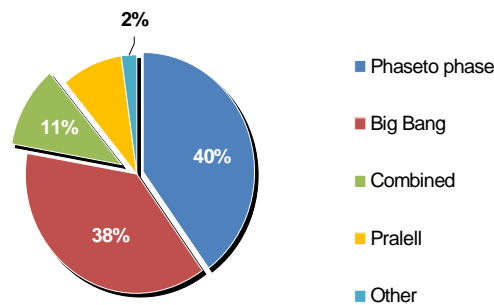


Figure 1. Usage of typical implementation strategies

From the above analysis of the advantages and disadvantages of specific strategy stands out as a phased implementation strategy best suited for large oil companies with no previous ERP experience. The risk of unsuccessful implementation should be minimized because adverse effects may lead to blockage of business processes or bankrupt companies. Gradual implementation provides the ability to detect problems and fixing bugs in preparation and setup of business systems, which reduce the number of errors in the subsequent phases of the project.

In the overall usefulness of information that is available right out of the information system is necessary to differentiate the needs of users and stakeholders of the four major factors:

1. Quality of information - how much good information from the standpoint of accuracy, precision, completeness, availability of time and resources;
2. Access to information - how easy it is to gather information to manipulate them;
3. Presentation of information - the level of summary and presentation format to the user, regardless of the quality and access to information;
4. Information security - how the information is under the control and protection due to improper, unauthorized or unlawful access to and use of data.

Professionals dealing with theoretical considerations of information technology developed a formulation of utility that is much more elegant than practical. This concept implies that the value of the information is possible only if it reduces uncertainty in practical decision-making [1].

Regarding these aspects previous information systems, before the decision on the implementation of an integrated information system did not allow automation of data collection on the same logistics processes in the company, different ways for access and manipulation of the same data, limited levels of reporting in different systems and different systems of authorised access to the data. Thus, the reporting problems were solved thru development of reporting in each business unit separately. Such approach is not appropriate for the expected level of results and only wide ERP implementation offers a solution for many different processes.

### Organizational aspects of implementation project

The organizational structure of the framework for the work of consultants and project teams is essential, but the people are the source of data and power to modify the ERP to the best solution from portrayed processes to the redesigned ones, in all aspects of logistics. The final solution must ensure that all relevant logistics data can be entered quickly and accurately and control the flowlines to improve the quality of reporting and enable effective business decision-making at all levels.

Defining internal operational resources involved in the realization and motivation are core activities in the preparation of a large project. The positive effects of marketing are passed on to the teams, but if management does not allow lower participation and motivation for the best staff, significantly

increasing the likelihood of errors in the implementation and decreases the quality of the implemented solutions. Correlation of logistics of procurement, storage and transportation in a supply chain conditions require equally high quality of work in all its stages.

For example, as a common approach, support services on the lowest level are organized as a customer self supporting resources. Some future organization can emerge as these units are recommended by SAP, as well as from the worlds best practices. Some of the most important are:

- Core Team - management of information systems for major processes;
- CCC Team - (Customer Competence Center) - IT support for managing and distributing of troubleshooting reports for the hardware or software;
- Authorisation Team - takes into account the consistency of permissions to users with different roles and levels of management, according to the approved Authorisation scheme and period of validity;
- Masterdata Maintenance Team - maintains a central database of materials, services, suppliers.

Logistics services managers coordinate logistics and new work model and organizational processes that are executed by a large number of employees with different tasks in a defined stream of materials and information. End-users of information systems managers and employees from all parts of the organization to which the implemented modules integrated information system .

Users of information systems can be [6] :

1 Knowledge workers - those who create new knowledge and information;

2 Workers with the data - those who use the information and distribute them.

Knowledge workers (knowledge workers) are the managers who KERIR new knowledge and information in the planning , reasoning and decision making. These are the activities at the strategic level .Operational level managers take account of the use and distribution of information , instruct workers to make different types of reports , this group includes logistics personnel engaged in specialized professions (economists , engineers , lawyers, etc.) .

Workers with the data they have lower levels of education and spend more time in the interpretation of information than their creation . This group includes secretaries, storage, transport, procurement officers, dispatchers, etc.

According to the recommendations of the consultant system users ( key specialists ) is to foster the development and optimization of a new system with at least 50 % of the activities in relation to IT specialist staff from the Department of IT . Logistics jobs have become closely associated with IT, therefore in logistics there are certain functions that were reserved for IT professionals.

- System Analyst - in planning combines data from SAP data out of the system in general , which is presented to the decision maker ;
- Database Administrator - Perform data entry and correction of records in the database in accordance with established company policies and internal regulations. With the introduction of the SAP system specific logistics activities and related activities took on new importance. Jobs in which he was engaged a large number of officers have been redesigned in line with the new organization of business units and profit centers and the direct responsibility of the director of manufacturing and service facilities for revenues and expenditures . Thanks to module business intelligence (BI), all changes in costs and revenues Plant immediately visible in the balance, which allows management to react rapidly to changes and micromanagement during the billing month.

**Table 1.** Required skills for selection of Code system maintenance Team

Roles of Team members	Requested skills			
	communicational	organizational	specialist	urgent situation solving
Team Leader for Code system maintenance	very advanced	advanced	advanced	very advanced
Analyst Class I	developed	developed	advanced	advanced
Analyst Class II	basic	basic	developed	basic

## RESULTS AND DISCUSSION

Quality, value and customer service are the focus of top management, because the marketing concept must achieve a high level of customer satisfaction and long-term profitability of the company. Logistics and men who are the perpetrators of logistics processes play a key role in this process. Adaptation, continuous improvement, employee autonomy and unity of the system have surpassed the optimal design, consistency of operations, management, process control, and the size of the economy. The development of logistics systems, there are different opinions about the values and issues that brought the marketing concept, but in developing functional solutions to business operations all identified similar business challenges.

The most common barriers to the implementation of modern logistics of the program are[5]:

- Change of corporate culture,
- Establishing a shared vision of organizations,
- Establishing employee ownership over the quality of the process,
- Winning the trust of senior management,
- The change management process,
- Training and education of employees.

Strengths of the company are human resources that need to be developed through specially developed programs to improve their knowledge and skills, and work on integration with other participants of the business process. Key users must be prepared to overcome obstacles in order to reach accurate information on business processes, and cultural barriers must be broken in the transfer of requirements to the consultants. Power of quality staff is used for correction of participants in formed teams, but it is difficult to quickly replace an experienced consultants who has expected to perform specified tasks and apply suitable solutions. It takes more work to improve the general level of knowledge about the implementation and communicate positive effects and future capabilities to the project staff. Without inner positive attitude there is a great risk of implementation delay or missing a target of development.

## CONCLUSION

Production and distribution of Oil and gas is deeply connected with the usage of advanced Information technologies. During the preparation and implementation of ERP solutions in the large oil companies in parallel it is mandatory to plan and implement a number of activities that result in not only the unification of business processes, but also modifications in the organization and the labor process. During the test, and setting the parameters manager can detect and correct a number of errors, but it is not possible to evaluate all the changes in the organization and business processes that will be followed after the commissioning of the entire process scenarios. What was first recognized as a positive effect of implementation, significantly improved communication between users on the same job with the wiring of all the users in a supply chain business scenario. New training and experience are pushing the boundaries of understanding the process modeled in the ERP system and the possibilities for self- resolving minor system problems. An important effect of the implementation of a unification and standardization of financial statements (minimizing redundancy in reporting). ERP enables an understanding of logistics activities and networking in a unique process of all participants in a number of business scenarios.

Large scale changes brought with new IT solutions are risky, and should be prepared by the people who are aware of perceived shortcomings in the implementation but believe in success and can communicate the benefits to the future users through various communication channels.

## Acknowledgment

Ministry of Science and Technological Development, Republic of Serbia financially support this research, under the project number TR32044 "The development of software tools for business process analysis and improvement".

## REFERENCES

- [1] Alter, S., 1999. Information Systems: A Management Perspective, Addison Wesley, San Francisco, pp.132,133
- [2] Baloglu, A., Implementating SAP R/3 in 21st Century: Methodology and Case Studies, Marmara University Computer Engineering, <http://www.tojet.net/e-book/SAPBook.pdf>,
- [3] Božić, V., Aćimović, S., 2004. Marketing logistics, Faculty of Economics, Belgrade, pp.493.
- [4] Houston, N., 2010. ERP Implementation Strategies – A Guide to ERP Implementation Methodology, <http://blog.softwareadvice.com/articles/manufacturing>
- [5] Kallinikos, J., 2004. Organizational and behavioral implications of ERP systems, Information, Technology and People, Vol.17/1. str. 17.
- [6] Stanimirović J, 2003. HR component of the development of business information system, Master of science thesis, Faculty of Economics, Belgrade, pp.91



## MANAGEMENT FOR CONTROL OF PROTECTION IN WORKING UNIT MINE BOGUTOVO SELO-UGLJEVIK

**Bojan Tešić, Miomir Stanković**

University of Niš, Faculty of Occupational Safety, Niš, Serbia

e-mail: bojan\_pupi@hotmail.com

**Abstract:** The research aims to analyze individual factors in the technological process of superficial exploitation of coal at WU Mine “BogutovoSelo”, as well as to define those factors which most contribute to increased risk in individual workplaces, and identify dangers and hazards in the workplace and work environment. In this way the defined sources and their contribution to the total risk are the basis for defining necessary measures for protection in organizational and technological aspects. The ultimate goal is elimination of risk or reduction of risk to an acceptable level; that is complete control of dangers and hazards in the technological process of exploitation of coal at WU Mine “BogutovoSelo”.

**Key words:** risks, injury, effect, safety

### INTRODUCTION

Working unit (WU) Mine Bogutovo Selo-Ugljevik is a part of Mine and Thermal-electric Plant Ugljevik Corporation Ugljevik, which represents an organization with long-standing experience in conducting complex technological processes which include research and preparation for coal excavation, excavation, transport, and enrichment of coal, followed by production of electrical energy and subsequent processes. In the scope and role in the economic system of Republic of Srpska, and Bosnia and Herzegovina as a whole, M and TP Ugljevik comprises the backbone for maintenance and development of the economy, as well as a springboard for expected development. Energy in general, and in particular that based on fossil fuels, is the focus of concern for the environment because of negative effects on the population. To increase productivity in the mining industry, the need for larger scale mechanized equipment and improved technology emerged. Increasing mechanization resulted in increased levels of risk, which led to mines and facilities for processing of minerals and other activities within it, to generate considerable risks and hazards for workers, [1].

### RISKS IN THE WORK ENVIRONMENT

Risk assessment at WU Mine was done on the basis of a modified AUVA (*Allgemeine Unfallversicherungsanstalt*- the method of an Austrian group which produces pulp and paper) and **BG** (*Die gewerblichen Berufsgenossenschaften*- methods of a German professional association) methodology. In determining data regarding risks and hazards in the workplace and work environment, grouping of risks and hazards was completed according to Regulations on the procedures for risk assessment in the work place and work environment, and the final grouping is shown in Table 1, [2].

**Table 1.**List of risks and hazards in the workplace and work environment with possible consequences [3]

<b>IDENTIFICATION OF RISKS AND HAZARDS IN THE WORKPLACE AND WORK ENVIRONMENT AND POSSIBLE CONSEQUENCES</b>			
<b>Mechanical hazards that occur with use of work equipment</b>			
<b>R.B.</b>	<b>Work Activity</b>	<b>Possible danger or hazard</b>	<b>Possible consequences</b>
1.	Vehicle control and vehicle inspection	Insufficient protection from rotating or moving parts	Various types of mechanical injuries, wounds, cuts, contusions.
2.	Internal transport	Free movement of parts or materials that could cause injury to an employee	Various types of mechanical injuries, wounds, cuts, contusions, lacerations, etc.
3.	Driving vehicle in traffic	Internal transport and movement of machines and vehicles, as well as the movement of certain work equipment	Bone fracture, soft tissue injury, serious injury, or fatal injury
4.	The process of electrolysis	The use of dangerous instruments of labor which can produce an explosion or fire	Various types of mechanical surface and internal injuries, burns of various scope and degree
5.	Work in disposer cabin	Inability or limitation of timely removal from the workplace, exposure to closure, mech. shock	Bone fracture, soft tissue injury, serious injury, etc.
6.	Reviewing of documents on risk assessment	Other factors that may occur as a mechanical source of danger	
<b>Hazards which appear in connection with characteristics of the job</b>			
7.	Work surfaces	Hazardous areas (floors and all kinds of walkways, surfaces with which an employee comes into contact with that have sharp edges-edges, protruding parts)	Sprains, contusions, abrasions. All types of mechanical, surface, and internal injuries
8.	Work at heights or in depth, in terms of regulations on health and safety at work	Control of unqualified workers	All varieties of mechanical or internal injuries can occur due to employee falls or falling objects from above
9.	Areas on thermo-electric plant	Work in restricted, or dangerous area (between two or more fixed parts, work in a confined space that is not well lit or ventilated)	All types of injuries, internal and external mechanical injuries, head injuries, injuries to blood vessels, etc.
10.	Work surfaces	The possibility of slipping or tripping (wet or slippery surfaces)	Sprains, contusions, abrasions, breaks
<b>Dangers that arise with use of electricity</b>			
15.	Daily inspection	The risk of direct contact with electrical parts and energized electrical equipment	Due to its thermal effects (burns) the impact on the chemical composition of the blood, internal bleeding, etc.
16.	Incorrect installation	Risk of indirect contact	Burns caused by foreign impact
17.	Work on the actuator	Risk of thermal effects developed from electrical equipment and installations (overheating, fire, explosion, electric arc, sparks, or others)	Irritant damage to the upper respiratory organs, irritant skin damage, etc.
<b>Hazards that arise or occur in the work process</b>			
20.	Control and tour of the plant and machinery	Chemical hazards, inhalation of dust and fumes, choking, ingestion, penetration into the body, poisoning	Irritant damage to the upper respiratory organs, irritant skin damage, etc.

**III International Conference Industrial Engineering and Environmental Protection 2013 (IIZS 2013)  
October 30<sup>th</sup>, 2013, Zrenjanin, Serbia**

21.	Control and tour of the plant and machinery	Physical hazards (noise, vibration, electro-magnetic radiation, and barometric pressure)	Temporary or permanent hearing loss, increased sweating, impaired peripheral circulation of the nervous system
23.	Control of settings of technological processes in the Operating units	Adverse effects of microclimate (high or low temperatures, humidity, and air velocity)	Prolonged exposure to high temperatures can cause increased fatigue, feelings of exhaustion, decreased concentration, etc.
24.	Work on the actuator	Inadequate or insufficient lighting	Unfavorable influence on the quality and productivity of work, physical condition of workers, and especially on the organ of sight, etc.
25.	Work with a computer	Damaging effects of radiation (ionizing and non-ionizing, thermal, laser)	Damage to skin, infrared thermal effects, the occurrence of cataract conjunctivitis, etc.
26.	Work on all locksmith jobs	Adverse climatic influences (outdoor work)	Increased fatigue, feelings of exhaustion, reduced concentration, impaired cardiovascular systems
27.	Process of storage hazardous substances	Risks arising from use of hazardous substances in production, transport, storage	Poisoning, burns, fires, and explosions
28.	Shooting fittings with dry saturated steam	Other damages that occur in the work process and which may be the cause of injuries to an employee, nesses related to work	Burns of I, II, III, and IV degree, and lasting consequences
<b>Hazards arising from work requirements which relate to physical and psychophysiological efforts</b>			
29.	During repairs	Efforts or physical stress (manual handling of loads, pushing or pulling loads)	Damage to the musculoskeletal system, particularly the spine, etc.
30.	Surveying layout details and technological schemes	Non-physiological body position (prolonged standing, sitting, squatting, kneeling)	Osteoarticularic changes of the spine, strain of muscles of the back, neck, and abdomen, etc.
31.	Archiving, copying, and issuing operating instructions as needed	Strain of individual organs and systems (vision and hearing), mental strain	Disturbances to organs of vision, asthenopia, disturbance of attention and concentration, fatigue, exhaustion, nervousness
33.	Collecting and archiving daily reports, charts, books, and other technological documentation	Responsibility for receiving and transmitting information, use of appropriate meaning and capability, responsibility in the rules of conduct, customer service, lack of motivation to work, responsibility in management	Mental fatigue, maladjusted behavior (smoking, alcoholism, drug addiction, job dissatisfaction, conflict, lack of discipline, etc.)

**MEASURES TO PREVENT, ELIMINATE, OR REDUCE RISK**

Beginning with estimated risk, established priorities, and respecting the principle of prevention, and in compliance with regulations on protection of health at work, technical regulations, standards and generally accepted measures, the following measures are determined to prevent, eliminate, or reduce risk at WO Coal Mine:

- Regularly provided funds and equipment for personal protection at work and their observance;
- Mandatory use of personal protective equipment at all positions for which protective equipment is provided;
- For work resources which do not have them, complete instructions for safe operation, handling, maintenance;
- Set up warning signs at all facilities where use of personal protective equipment is obligated;

- Provide medical kits and trained staff to provide first aid in all facilities;
- Mandatory use of personal protective equipment for the protection of hearing;
- Carry out systematic measurements of working conditions for winter and summer periods for all jobs;
- Perform general vibration level measurements in all workplaces where workers are exposed to vibration;
- Evacuation routes must be maintained as clean and walkable spaces;
- In case of injury of an employee, immediately initiate first aid, call an ambulance, or if necessary transport the injured to the nearest health facility;
- Daily visual check for accuracy of line connections of machinery and equipment;
- Regularly completing inspection of electro-energy lightning protection by an authorized institution;
- Work on electrical installations to be done with proper tools and in a safe manner;
- All (Wo) Work organization must have single-line diagrams, protection for elements inside cabinets, insulating mats in front of the Wo;
- Regular cleaning of stationary and mobile crushing plant from waste and dust;
- Conduct preliminary and periodic inspection in accordance with Regulations on previous and periodic examinations of workers in workplaces with high risk;
- Jobs in offices designed in accordance with ergonomic principles (desk, chair, computer);
- Fortification of methodology and programs for employee training for safe operation of all jobs, and in accordance with specifics of the workplace and risks in individual workplaces;
- All potential harmful and hazardous materials must be stored in appropriate facilities and kept under labeled conditions and in special containers;
- All planned mechanical equipment and installations should comply with applicable BAS standards and norms of quality. All installed equipment and installations must be protected with covers and tested with trials of required pressure and airtight insulation;
- Before every re-starting the plant must be inspected and set up with safety equipment and it must be determined that there are no uninvited workers or unwanted objects present in the working area, and when beginning work a designated sound signal should be given;
- Schedule of work resources must be such that workers handling as well as workers who are in the immediate vicinity are not endangered by possible mechanical injury;
- Conduct regular technical inspection, examination, maintenance, and repair of machines and equipment used in the manufacturing process;
- Regularly perform control and record keeping for accuracy and maintenance of machinery and equipment;

#### **Organizational and normative safeguards**

Under current legislation the organization has the following obligations in relation to the implementation of safety measures, conservation of work ability and health of workers:

- To implement timely measures for protection at work;
- To provide workers with personal protective equipment and safety equipment;
- In case of need, to organize fire protection service;
- To fulfill these obligations through existing service of safety at work and fire protection;
- The existing potential threat of chemical and physical hazards indicates the need to regularly monitor the situation in the workplace so that, if needed, all necessary measures of protection can be promptly taken;
- In accordance with current regulations, periodic testing (winter and summer) should be implemented for chemical and physical hazards, microclimate and lighting conditions, by an authorized institution; [4], [5], [6].

For needs of operational monitoring of the impact of chemical and physical hazards, that is working conditions in work environments, they are determined by the organization for work safety through the following activities:

- Recording and analyzing the parameters of dust, harmful gases, noise, vibration, climate, and lighting conditions in the work environment;
- Control of functioning of embedded devices for dust collection and air conditioning systems;
- Control of equipment and machines from the viewpoint of measures undertaken for protection from injury;
- Management of specific documentation and reporting on the state of chemical and physical hazards in work environments;
- Manner of completion of these jobs should be regulated by the general act- Rules of Safety at Work;
- It is necessary to carry out periodic medical examinations, put warning signs for danger or dangerous places. With a work program, ensure that conveyor belts and similar devices must be stocked with equipment for immediate stopping at any time, sloping platforms, and pedestrian crossings. Stairs and ramps must be equipped with handrails, foot stoppers, and non-slip surfaces.

In accordance with applicable regulations, in the further process of implementing safety at work, technical documentation on jobs with special conditions of work and workplaces should be provided.

## **CONCLUSION**

Implementation of measures to prevent, eliminate, or reduce risks, dangers, and hazards in the workplace and work environment would reduce to the lowest level, the monitoring of risks could be controlled at all times, and most importantly, the number of injuries to workers in WU Coal Mine would be significantly lower as compared with today. In this manner, the potential problem of increased risk would be approached in an integrated way, which involves the application of active and passive protection measures, based on research and supported by appropriate legislation.

## **REFERENCES**

- [1] Tesic, B., Propagation of noise in PK Bogutovo Selo-Ugljevik, pp.5 – 7, 2012.
- [2] Document of risk assessment in the workplace and working environment, ZP „RiTE Ugljevika“ a.d. Ugljevik
- [3] Internal identification of risks and hazards in the workplace and working environment and possible consequences, R i TE Ugljevik, 2012.
- [4] „The mining act“ (Official gazette of R. Srpska ..)
- [5] EU Directive 89/391/EEZ on the introduction of measures to encourage and improve the safety and health of workers;
- [6] The law on occupational safety ( „Official gazette of Republic of Srpska“ br. 01/08).

## COMPARISON OF PERFORMANCES OF MICRO HYBRID TRIGENERATION SYSTEMS FOR ENERGY DEMANDS OF A SMALL RESIDENTIAL BUILDING

Marko Mančić<sup>1</sup>, Dragoljub Živković<sup>1</sup>, Milan Đorđević<sup>2</sup>, Milena Todorović<sup>1</sup>, Saša Pavlović<sup>1</sup>

<sup>1</sup> University of Niš, Mechanical Engineering Faculty, Niš, Serbia

<sup>2</sup> University of Priština, Faculty of Technical Sciences in Kosovska Mitrovica, Kosovska Mitrovica, Serbia

e-mail: [markomancic@yahoo.com](mailto:markomancic@yahoo.com)

**Abstract:** Micro hybrid trigeneration systems are small plants for production of heating, cooling and electricity which take advantage of renewable energy sources. The structure of such system depends on availability of local energy sources and on-site energy demands. In this paper, results of simulations of possible layouts of micro hybrid trigeneration systems, based on renewable energy sources: solar energy, geothermal energy and fossil fuels are presented. Simulations are performed using TRNSYS software. System sizing is done based on energy demands of a small residential building. Feasible trigeneration systems layouts are determined and simulations of annual production of heating, cooling and electricity, using solar thermal collectors, photo-voltaic, heat pump, internal combustion engine and hot water boiler, is performed. Analysis of obtained results implies positive and negative aspects of using each of the technologies as part of a micro hybrid trigeneration system and determines boundaries for using renewable energy sources in small residential buildings.

**Key words:** micro-trigeneration, annual performance simulation, renewable energy sources

### INTRODUCTION

Trigeneration represents a process of energy conversion for combined heating, cooling and electricity production. Application of trigeneration systems provides possibilities for significant overall energy efficiency improvement and reductions of green house gas emissions [4,8]. Trigeneration plants are complex energy systems which take advantages of combined energy production technologies [13]. Application of an energy system depends on real local demands, available resources as well as justification and profitability of their use. Available technologies bring possibilities to use renewable energy sources (RES) as well as fossil fuels.

In this paper, different layouts of micro trigeneration systems are analyzed. Solar energy, geothermal energy and natural gas applications are considered in the system design phase. System sizing was done according to energy demands of an energy efficient residential stand-alone building. Analysis included the following micro trigeneration concepts for residential buildings (figure 1): (1) Photo Voltaic (PV) array with a ground source heat pump, (2) Photo Voltaic - Thermal solar array with a ground source heat pump, (3) Solar thermal collector array with a hot water fired absorption chiller and a gas fired internal combustion engine. Only roof mounted solar collector array are considered, with the same available area in all three cases. TRNSYS software simulations are used to determine performance of the possible designs. Results are compared and discussed in the paper.

### SIMULATED PERFORMANCE OF MICRO TRIGENERATION SYSTEMS

The possibilities for using fuel cells, stirling engines, internal combustion (IC) engines for households can be analyzed using TRNSYS software. According to the authors belief, fuel cells and stirling engines are still not as mature nor available, especially in the domestic market, so the cogeneration block should be based on a micro gas turbine or a gas fired IC engine [16,21]. Micro-turbines offer electricity production efficiency of around 30%, possibility to use more types of fuel, and total efficiency in cogeneration mode can reach above 80% [16]. Compared to IC engines, Gas turbines have better quality of waste heat, lower maintenance and vibrations. Nevertheless, in small scale applications, IC engines provide better efficiencies [16,2], their usage is both economically and financially more profitable [13,14]. Due to their lower initial costs, they are used for power ratings

bellow 30kW, leaving them more popular for small scale cogeneration (trigeneration) systems. Waste heat temperature can be up to 160 °C, with pressures up to 20 bar [16], which is enough for meeting space heating or cooling demands. Temperature of the water used for engine cooling is usually in a range of 85-90°C, while the temperature of cooling air (or low pressure steam) ranges between 100-120°C, which is suitable for hot water heating, low pressure steam production, sanitary hot water preparation or cooling using sorption devices [16].

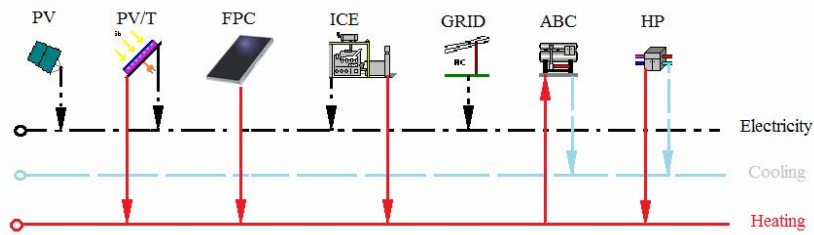
Waste heat of the cogeneration block is usually used directly for heating, or indirectly for cooling via heat fired chillers or heat pumps [19]. For utilizing low temperature energy sources, heat pumps taking advantage of gas adsorption or sorption, when thermo-chemical energy of a reversible chemical reaction is used to change the temperature level of available heat [12,20]. According to the review of the performances, an absorption Li-Br/water device was chosen as most suitable for small scale residential applications, requiring input and output temperatures of 80-90°C and 6-7°C [20].

Heat acquired by solar collectors is used directly for water heating, indirectly for cooling using heat fired refrigeration units, or it is stored in heat storage units [7]. In this paper, PV/T collectors are considered, as water cooled PV panels mounted on the absorber of a flat plate solar collector. For utilization of low temperature energy sources, heat pumps which change the temperature level of available heating energy by heat source and adsorption of vapour or gas sorption can be used [11,20]. Application of trigeneration systems based on use of PV/T collectors has already been analyzed [3] in combination with absorption heat pump and supplementary water heater and concentrating PV/T collectors [15]. The performance of PV/T solar collectors is further analyzed in [2,3,6, 8,15]. Water temperature at hybrid PV/T collector outlet is usually not sufficient to directly power the sorption chillers, thus imposing the need for additional heating. Higher price of sorption cooling devices and the low cooling energy demand of the model, give advantage to the use of water-water heat pump [18].

For energy demands of the building model, micro trigeneration systems are designed and their performance is investigated. Photovoltaic (PV) technologies are recognized as one of the most suitable for decentralized electricity production in urban areas [1,5]. Adequate technical approach implies economical PV production for maximum electricity generation by mounting the panels only on the south roof surface of the house [5]. Houses equipped with heat pumps as main source for heating are considered to have the lowest energy consumption and the lowest energy intensity [12]. Availability of acquired heating energy is increased by a low temperature thermal storage tank, which is heated by a water-water heat pump. Hence, solar energy can be utilized by use of solar collectors for production of heating and electricity. Obtained thermal energy can be used directly for heating water or cooling by heat powered cooling systems, or for accumulating the energy by thermal storage [1,5,18].

The investigated trigeneration systems are designed for the energy demands of a single residential building, with the net heated area of 160 square meters. The investigated model is a simple two floor house model, with a basement, and compact shape. The building thermal loads are simulated using TRNSYS 17 software multi-zone building model. The building is modelled as energy efficient, with an U-value of the building envelope non transparent elements of less than 0.2 w/m<sup>2</sup>k and 1,3 wW/m<sup>2</sup>K for the transparent elements. Building ventilation is natural. Aluminium-wood windows with a "thermal brake" are considered with glazing of low emissivity, three-layer glass with inter-sheet space filled with argon. The building was divided into three zones: non-heated attic space, non-heated basement and residential area. Energy balance of heating and cooling loads was calculated for the residential area, with defined interior temperature of 20°C. Typical Meteorological Year (TMY) weather data for Belgrade is used in the simulation.

In this paper, the effect of trigeneration is achieved as follows: (1) electrical energy is obtained by application of hybrid solar PV/T collectors [9], PV collectors, or by use of an internal combustion engine (ICE); (2) heating energy is acquired by use of ground source heat pump (water-water), solar thermal collectors waste heat from PV/T collectors and waste heat from the ICE; and (3) cooling energy is provided using the Heat Pump, or the hot water fired absorption chiller. A scheme of possible system configurations is presented in Fig. 1.



**Figure 1.** Scheme of simulated micro trigeneration configurations:

*PV- Photo voltaic array; PV/T- photo-voltaic/thermal collectors, FPC - flat plate solar thermal collectors, ICE - Gas fired Internal Combustion Engine, GRID - national power supply network, ABC- Hot water fired absorption Chiller, HP- water-water heat pump*

## RESULTS AND DISCUSSION

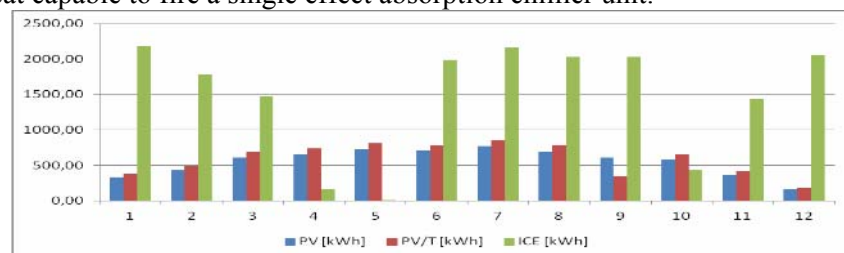
Simulation results are obtained using TRNSYS simulation environment, for the micro trigeneration system configurations described. Results are summed over time to obtain monthly performance data, which is presented in this paper. A monthly annual production balance of each of the components is given in the paper. The simulated performance of the components represents their behaviour as part of a given system. All components of the system are sized according to the demands of the given building model.

Availability of solar thermal systems was improved by adding a 1m<sup>3</sup> thermal storage to the system. Thermal storage is assumed to be ideally mixed for the purpose of the simulation, i.e. thermal stratification within the storage tank is negligible. Available south side roof area for mounting solar collectors is 28,3m<sup>2</sup>, with a slope of 45°. The simulation envisages the use of this entire area for mounting solar collector arrays. Utilization of vertical facades for mounting solar collectors is also possible, but has proved inefficient for electricity production [10].

Identified possible configurations of micro trigeneration system are the following: 1) trigeneration system based on PV collectors and water-water heat pump; 2) trigeneration based on PV/T collectors and water-water heat pump; 3) trigeneration system based on ICE and absorption chiller, 4) Trigeneration system based solar thermal collectors aided by ICE and absorption chiller. Performance of each of these system is given in a component wise manner in the following figures.

The simulation of performance of an array of roof mounted PV collectors is given on figure 2. Total simulated annual electricity production summed to 6652 kWh, and the average electric efficiency was 12%. PV/T collectors showed a slightly better performance, with total annual electricity production of 7159kWh, and the average electric efficiency of 0,14. (Fig. 2). In addition, PV/T collectors provide waste heat which is fed to the heat storage unit, for further utilization in the system. Electricity produced by PV and PV/T collectors are compared in Fig. 2. The electricity produced can be used to power a water-water heat pump, or exported to the grid.

Monthly annual electricity production of a 4.5 kW natural gas fired ICE is compared with the performance of PV and PV/T collectors in Fig. 2. The ICE is operated to follow heating load of the building in heating season and to fire the absorption chillier in cooling season. It is available to provide heating in winter, when the performance of solar applications is poor, and can produce high temperature heat capable to fire a single effect absorption chillier unit.



**Figure 2.** Comparison of electricity production of proposed units

Average electrical efficiency of the engine was below 40% during the simulation. Heating production using different units is presented in Fig. 3.



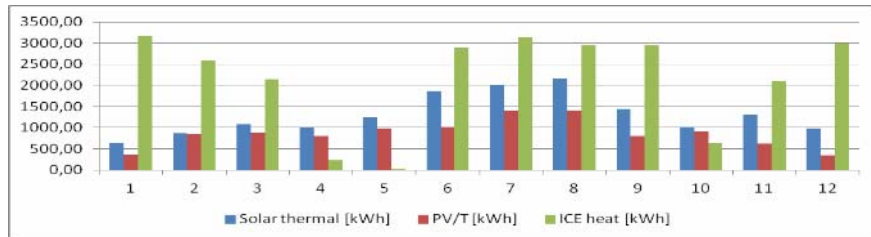


Figure 3. Comparison of heating performances of the investigated units

Available heat from either PV/T collectors or Solar thermal collectors is not sufficient for space heating during heating season, but the natural gas fired ICE is capable of providing sufficient heat when needed. Water-water heat pump can also be used for both heating and cooling, but it requires electricity for its operation. Annual performance of the heat pump is given in Fig. 4.

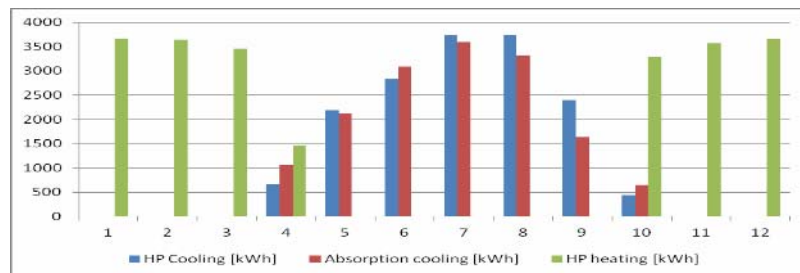


Figure 4. Comparison of performance of water-water heat pump and absorption chiller

Heat pump can utilize electricity from the grid, or locally produced electricity by one of the proposed production units. While solar applications do imply any direct operation costs, ICE requires considerable quantities of fuel and water-water heat pump consumes electricity for its operation. Annual monthly consumption of natural gas required for operation of ICE and electricity required to power the heat pump are given in Fig. 5. Operation cost analysis is not performed in this paper.

The simulated absorption chiller is a single effect unit with minimal input source temperature of 85.6 °C. Although better cooling efficiencies are achieved with higher input source temperatures, heat supply was for the purpose of the simulation was set to provide at least the minimum required temperature, but not greater than 95°C. Solar thermal collector array is capable of reaching simulated temperatures in this range in July and August. However, the simulation showed that the use of an additional heating source is required to provide constant flow of hot water with such temperatures, even with the use of 1m<sup>3</sup> heat storage. This is achieved by using waste heat from the ICE. The simulation assumes, that 40% of the total available ICE waste heat (Fig. 3) can be utilized further effectively.

Electricity consumption of the building was not analyzed in this paper. It is assumed, that surplus electricity can be exported to the grid, and taken from the grid when needed. However, total production rates of investigated units are compared in the paper.

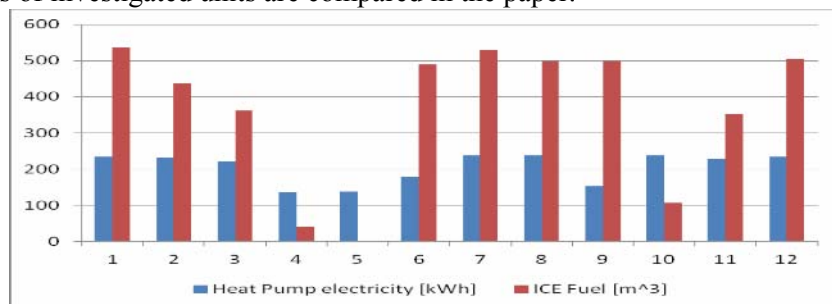


Figure 5. Monthly annual balance of natural gas consumed by the ICE and electricity consumed by heat pump

Total annual production of heating, cooling and electricity of the investigated units is given in Fig. 6.

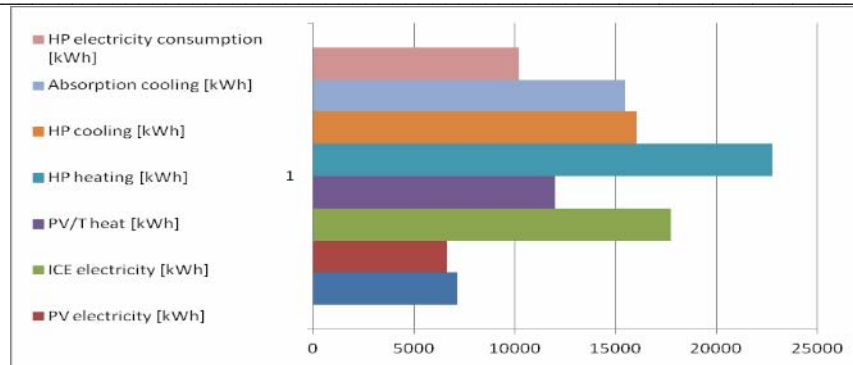


Figure 6. Annual balance for heating, cooling and electricity per investigated unit

Fig. 6 shows that greatest electricity production can be achieved by the ICE engine. In addition, the ICE is capable of producing enough heat to fire the absorption chiller or enough electricity to power the water-water heat pump. Neither PV nor PV/T collectors are capable of producing enough electricity to meet the demand of the heat pump; hence electricity deficit in this system must be compensated by electricity import from the grid. Heat acquired by use of PV/T collectors is low temperature heat which is not sufficient to power the absorption chiller, however it may be possible to utilize as heat source for the water-water heat pump.

## CONCLUSION

Different possible design configurations of micro trigeneration systems are compared in this paper for the demands of small building. With the limited available roof area for mounting neither PV nor more efficient PV/T collectors can provide enough electricity to meet the annual demand of the water-water heat pump. In addition, output temperature of the PV/T collectors is not high enough to fire the absorption chiller; hence an additional heating source is required in such case. Contrary, use of solar thermal collectors can provide high enough temperature heat to fire the absorption chiller, but an additional heating source is required for space heating and ensuring input source temperature for the absorption chiller at all times. Although ICE is used for this purpose in the simulations, other conventional heat sources can also be used. Simulated performances of the ICE engine showed that it is capable of providing high enough temperature heat to fire the absorption chiller for the cooling season as well as provide enough heat to meet the heating load in the heating season. Electricity produced by the ICE can also be used to power the ground source water-water heat pump. In such case, total annual electricity produced by the ICE is greater than total annual electricity required by the heat pump. Although the ICE raises significantly availability of the simulated trigeneration systems, it also requires significant amounts of fuel to operate.

## Acknowledgement

This paper was done in the framework of the project III 42006 – “Research and development of energy and environmentally highly efficient poligeneration systems based on utilization of renewable energy sources” (2011-2014), financed and supported by the Republic of Serbia Ministry for Education and Science.

## REFERENCES

- [1] Bojić, M., Blagojević, M., Photovoltaic electricity production of a grid-connected urban house in Serbia, *Energy Policy*, Vol.34, No.17, pp.29-41, 2006.
- [2] Calise, F., Dentice d'Accadia, M., Palombo, A., Vanoli, L., Dynamic simulation of a novel high-temperature solar trigeneration system based on concentrating photovoltaic/thermal collectors, *Energy*, Vol.1, 2012., Article in press.
- [3] Calise, F., Dentice d'Accadia, M., Vanoli, L., Design and dynamic simulation of a novel solar trigeneration system based on hybrid photovoltaic/thermal collectors (PVT), *Energy Conversion and Management*, Vol.60, 214, 2012.

- 
- [4] Chicco, G., Mancarella, P., A unified model for energy and environmental performance assessment of natural gas-fueled poly-generation systems, *Energy Conversion and Management*, Vol.49, pp.2069-2077, 2008.
- [5] Elsawaf, N., Abdel-Salam, T., Abaza, H., Economic evaluation and calculations of energy savings by upgrading the heating systems in pre manufactured homes, *Energy and Buildings*, Vol.59, 187, 2013.
- [6] Fraisse, G., Me'ne'zo, C., Johannes, K., Energy performance of water hybrid PV/T collectors applied to combisystems of Direct Solar Floor type, *Solar Energy*, Vol.81, 1426, 2007.
- [7] Hasnain, S. M., Review on sustainable thermal energy storage technologies, part I: heat storage materials and techniques, *Energy Convers. Mgmt*, Vol.39, No.11, pp.1127-1138, 1998.
- [8] Henning, D., Amiri, S., Holmgren, K., Modeling and optimization of electricity, steam and district heating production for local Swedish utility, *European Journal of Operational Research*, Vol.175, pp.1224-1247, 2006.
- [9] Jin-Hee, K., Jun-Tae, K., Comparison of electrical and thermal performances of glazed and unglazed PVT collectors, *International Journal of Photoenergy*, 2012.
- [10] Jovanović, G., Živković, D., Mančić, M., Stanković, V., Stanković, D., Stefanović, V., Mitković, P., A model of a Serbian energy efficient house for decentralized electricity production, *Journal of Renewable Sustainable Energy*, Vol.5, 04 1810, 2013.
- [11] Jovanović, S., Djordjević, Z., Bojić, M., Savić, S., Stepanović, B., Weather conditions impact on electricity consumption, *Proceedings of Conference on Mechanical Engineering Technologies and Applications COMETA 2012*, Jahorina, Republic of Srpska, pp.409-415, 2012.
- [12] Kalogirou, S., Recent Patents in Solar Energy Collectors and Applications, *Recent Patents on Engineering*, Vol.1, pp.23-33, 2007.
- [13] Mančić, M., Živković, D., Stefanović, V., Pavlović, S., Feasibility of Small Scale Trigeneration for Decentralized Energy in Commercial Buildings, *Proceedings of the 7th International Symposium KOD 2012*, Balatonfüred, Hungary, 2012.
- [14] Mančić, M., Živković, D., Stefanović, V., Pavlović, S., Possibilities for small and micro trigeneration for decentralized energy production, *Proceedings of the International Conference On District Energy 2012*, Portorož, Slovenia, 2012.
- [15] Matuska, T., Sourek, B., Façade solar collectors, *Solar Energy*, Vol.80, 1443, 2006.
- [16] Onovwionaa, H.I., Ugursal, V.I., Residential cogeneration systems: review of the current technology, *Renewable and Sustainable Energy Reviews*, Vol.10, pp.389-431, 2006.
- [17] Pilavachi, P.A., Mini- and micro-gas turbines for combined heat and power, *Applied Thermal Engineering*, Vol.22, pp.2003-2014, 2002.
- [18] Ramanathan, R., Ganesh, L., A multi-objective evaluation of decentralized electricity generation options available to urban households, *Energy Conversion Management*, Vol.35, 08661, 1994.
- [19] Šašmalović, S., Toplotna pumpa, tehnologija održive proizvodnje energije, Savez mašinskih i elektrotehničkih inženjera i tehničara Srbije (SMEITS), Belgrade 2009.
- [20] Ziegler F., Recent developments and future prospects of sorption heat pump systems, *International Journal of Thermal Science*, Vol.38, pp.191-208, 1999.
- [21] Živković, D., Milčić, D., Mančić, M., Moderne tehnologije za male i mikro trigeneracione sisteme, *Proceedings 42. International congress on Heating, Ventilation and Climatization*, Belgrade, 2011.

## THE IMPACT OF CLOUD COMPUTING IMPLEMENTATION ON A COMPANY'S ECO POLICY

Vladimir Čolić<sup>1</sup>, Savina Čolić<sup>2</sup>, Višnja Ognjenović<sup>2</sup>

<sup>1</sup>NIS Gazprom Neft, Novi Sad

<sup>2</sup>University of Novi Sad, Technical Faculty "Mihajlo Pupin", Zrenjanin

e-mail: [colicv88@gmail.com](mailto:colicv88@gmail.com)

**Abstract:** As an emerging technology, Cloud computing poses important questions about its environmental sustainability. While the extant literature gives numerous examples of financial benefits obtained through Cloud computing, its energy efficiency has not been analyzed in sufficient detail. Utilizing large shared virtualized datacenters, Cloud computing can offer large energy savings. However, Cloud services can also increase the Internet traffic and its growing information database which could decrease such energy savings. Thus, this paper explores the environmental sustainability of Cloud computing by analyzing various technologies and mechanism that support this goal.

**Key words:** Cloud Computing, Sustainability, Energy Efficiency, CO<sub>2</sub> reduction

### INTRODUCTION

Being one of the newest trends in the world of information technology, cloud computing gives rise to the following strives, present in almost every aspect of today's life: to be cheaper, faster and greener. In order to be more competitive and therefore successful in any aspect of modern life, one needs to do things at a lower cost, greater speed compared to the others and with the least possible negative impact on the environment. This is the reason why cloud computing is being rapidly implemented in companies across the globe.

However, as [7] state, the growing demand of Cloud infrastructure has drastically increased the energy consumption of data centres, which has become a critical issue. High energy consumption both reduces the profit margin of Cloud providers and leads to high carbon emissions, which is completely opposite to green.

Hence, this negative impact needs to be minimized through energy-efficient solutions. These solutions can be designed only after a deep analysis of Cloud, with respect to their power efficiency.

### MATERIAL AND METHODS

#### Company Cloud Benefits

Business people are becoming more and more aware of the amount of energy IT systems consume and their environmental impact nowadays. This is the reason why the business world is increasingly seeing the implementation of a greener solution - Cloud computing. The idea behind this notion is storing data not locally, but on an external, outsourced server. This practically means that the need for bulky hardware and expensive software does not exist anymore. The advantages are numerous for an organization – environmental footprint of using cloud computing, as compared to having an internal IT system, can be reduced by up to 90%; moreover, it leads to the elimination of hardware obtaining, administering and maintaining, which provides great cost reduction. Apart from that, the problem of space lack and cooling is avoided in this way. Technology efficiency is greater in Clouds than in traditional data centers due to idle time optimization.

Cloud service providers need to keep their cost low. Therefore they need to ensure there is no energy waste through focusing on performance. In fact, as [5] states, they provide maximum of services with the least resources (including energy), which in the final instance is the basis of being green.

When comparing Cloud computing to in-house data centers, one can see that utilization rates in shared data centers can be, most frequently, around 60 to 70%, while at the same time they amount only 5 to 10% in most corporations. Therefore, the shared resources and energy costs lead to maximum cost reduction through increased energy efficiency. On the other hand, with in-house data centers, companies may not be able to afford to keep upgrading to energy-efficient equipment, lacking space and finances. Anyway, they will often be forced to purchase more machines than necessary in order to handle peak data loads. In Cloud computing option, these resources can be allocated dynamically where needed.

### **Cloud and Environmental Sustainability**

As it could be seen from the previous chapter, the notion of Cloud computing evokes the thoughts of sustainability, greenness, and significant energy savings. Indeed, one of the main driver technologies for energy efficient Clouds is 'virtualization', which allows significant improvement in Cloud energy efficiency by leveraging the economies of scale associated with large number of organizations sharing the same infrastructure. In this way, companies can gain high savings in the form of space, management, and energy.

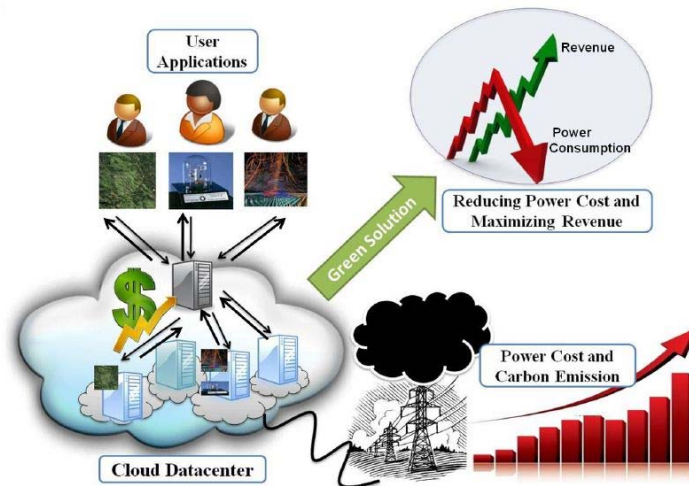
On the other hand, commercialization of thousands of simultaneous e-commerce transactions and millions of Web queries a day, today known as Cloud computing, brought to an alarming rise in internet usage during the last decade. Architecturally, this trend is supported through large-scale datacentres, which consolidate thousands of servers with cooling, storage infrastructure and network systems. The basic idea behind it is that the data in use are not stored locally, i.e. on hard drive of individual user, but on a remotely located server owned by so-called cloud vendor. In fact, most Internet users nowadays already use cloud computing, being completely unaware of that fact (e.g. web-based e-mail). This is the reason why, at a first glance, Cloud computing looks green.

However, when transferred to the business field, its implications on both company's profit and environment still need to be questioned. Traditionally, companies needed to invest great deal of capital and time in acquisition and maintenance of IT resources. Cloud computing shifts this approach from owning to subscribing, by providing access to scalable infrastructure and services on-demand. Therefore, the issue of purchasing, configuring, administering and maintaining own computer infrastructure is no longer present – now users can store, access, and share any amount of information on cloud, which the vendor is responsible for. Thus, the companies can focus on their core competencies, while the vendors provide all the necessary services to maintain the infrastructure working.

### **Not so Green a Cloud**

As already stated, providing Cloud services to companies significantly reduces client company's costs regarding manipulation of own IT resources. However, a question needs to be posed: is Cloud introduction a real solution or the problem is merely being shifted from the core to the outsourcing company?

In fact, while on one hand this significantly reduces company-purchasers' cost, on the other, it increases the carbon emission to a critical level (Figure 1). Therefore, various elements of Clouds which contribute to the total energy consumption need to be revised, as well as the more efficient solutions to be provided in order to make Cloud which is factually 'green'.



**Figure 1.** Cloud and environmental sustainability (Source: Bianchini, R., Rajamony, R., Power and Energy Management for Server Systems, Computer, Vol.37, No. 11, pp. 68-74, 2004.)

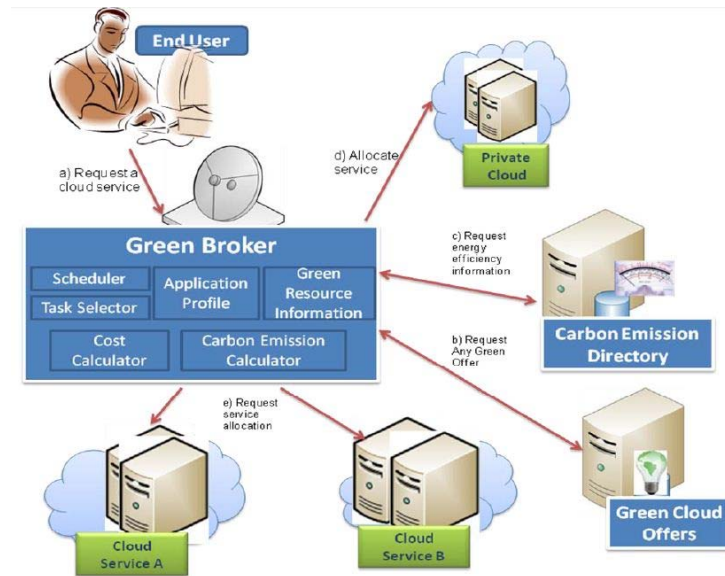
Due to the high-level energy consumption (estimated to 2% by [6]), the carbon emission by Cloud infrastructures has become a key environmental concern. According to a report published by the European Union, a decrease in emission volume of 15-30% is required before year 2020 in order to keep the global temperature increase below 2 °C. [4] observe that the Cloud phenomenon deepens the problem of carbon emissions and global warming. According to this source, the main problem is that the collective demand for computing resources is expected to further increase dramatically in the next several years. This means that even the most efficiently built datacenter will only mitigate, but not eliminate the harmful emissions of carbon dioxide. One of the main problems here is the idle time. In fact, no company ever uses 100% of its IT resources, 100% of time – which practically means that the great deal of power is being spent inefficiently. Apart from that, this problem is aggravated by the fact that the cloud vendors seek to reduce their electricity cost, but not the carbon emission as well.

### Efforts to Make Clouds Green

Even though various components were made efficient in terms of power and performance, the unified picture still does not exist. If the file sizes transferred to and from cloud are large, the network will become a major contributor to energy consumption, leading to the state where it is still better to run an application locally, from hard drives, than from clouds. In fact, various research strives focused on individual components of Cloud computing, while neglecting the effects of the other, which gives the results not suitable for overall energy efficiency. Therefore, a unified solution should be proposed so as to achieve Green Cloud computing in the real sense of the word.

The ultimate goal of Green Cloud architecture is to make cloud ecological from both user and provider's perspective. It is, as [7] propose, done by introducing a middleware Green Broker that manages the selection of the greenest Cloud provider to serve the user's request. He does it by obtaining the information on current status of energy parameters for using various Cloud services from Carbon Emission Directory (which maintains all the data on Cloud service's energy efficiency). Afterwards, the Green Broker calculates the carbon emission of all the Cloud providers who are offering the requested service and based on that, selects the set of services that will result in minimal carbon emission.

The design of this architecture is aimed to keep track of the overall energy usage when serving a user's request. Its two main parts are Carbon Emission Directory and Green Cloud offers, which track energy efficiency of each Cloud provider, stimulating them to make their service 'green' at the same time (Figure 2).



**Figure 2.** Green Cloud Architecture (Saurabh, K. G., Rajkumar, B., Green Cloud Computing and Environmental Sustainability, p.20, 2011.)

This was proved through several individual researches. For instance, a case study conveyed by [7], focused on IaaS (Infrastructure as a Service) providers who offer IT resources to execute users' HPC applications. Its results show that the green policies reduce the carbon emission by almost 20% in comparison to profit-based ones, having the minimal effect on the provider's profit at the same time. However, this cannot be achieved only by improving the efficiency of equipment, but through making Cloud computing usage more carbon efficient from both user and provider's perspective. Cloud providers need to shift towards using renewable energy sources and give priority to their computation resources energy efficiency in comparison with mere cost minimization.

When transferred to the private cloud model, used for internal organizational users (and thus provided to a smaller number of users), the provider needs to size its ICT infrastructure for the peak usage. This practically means that the private cloud providers suffer greater load variations, since their users, most often a company's employees, will probably use it significantly less during night, compared to day, and weekends, compared to weekdays. This is the reason why this type of cloud can save energy by optimizing the infrastructure to run the load with the lowest energy consumption, meanwhile preserving the service level agreements with respect to their users.

## CONCLUSION

This paper explores the issue of Cloud computing, with regard to its impact on the environment. As it could have been seen, the researchers' opinions vary, mostly due to the lack of a general overview of cloud energy efficiency. While on one hand numerous researchers praise the energy- and cost-saving nature of cloud, viewed from the customer company's position, on the other, many of them focus on the actual energy consumption by Cloud servers. To sum up, both of these viewpoints need to be taken into account so as to acquire a complete picture.

Cloud computing already does have a green lining, by providing computation resources to many customers, which increases their utilization rates. Nevertheless, in order to handle peak times and simultaneous requests from multiple customers, these servers need to be powerful and therefore they consume a great deal of energy. This all can be tracked in the sense of its carbon footprint, which is actually the first step towards making Cloud technology greener. The following step is, as proposed, to introduce the middle tier, which role would be to manage the customers' requests towards Cloud

providers, with regard to greenness. Specifically, this means that, having information on current use of cloud providers' resources, the middle tier decides which server to send the user's request to, according to the usage. The server which is less used at the moment will be assigned for the task and therefore, less electric power shall be used. In the final instance, the carbon footprint of the cloud will be reduced, which is the main goal.

The future research direction should be in the sense of the middle tier request directing speed, since at this point a problem is likely to occur – the final users' requests need to be solved, obeying the green policy at the same time. After addressing this issue, the following period make Cloud have a factually positive impact on companies' eco policy.

## REFERENCES

- [1] Abdelsalam, H., Maly, K., Mukkamala, R., Zubair, M., Kaminsky, D., Towards Energy Efficient Change Management in a Cloud Computing Environment, Proceedings of 3<sup>rd</sup> International Conference on Autonomous Infrastructure, Management and Security, The Netherlands, 2009.
- [2] Accenture Microsoft Report. 2010. Cloud computing and Sustainability: The Environmental Benefits of Moving to the Cloud, retrieved from [http://www.wspenvironmental.com/media/docs/newsroom/Cloud\\_computing\\_and\\_Sustainability\\_-\\_Whitepaper\\_-\\_Nov\\_2010.pdf](http://www.wspenvironmental.com/media/docs/newsroom/Cloud_computing_and_Sustainability_-_Whitepaper_-_Nov_2010.pdf) on 5/10/2013
- [3] Bianchini, R., Rajamony, R., Power and Energy Management for Server Systems, Computer, Vol.37, No. 11, pp. 68-74, 2004.
- [4] Cloud Computing: The Latest in Tech Also Has Hidden Environmental Benefits, retrieved from [http://www.sustainablebrands.com/news\\_and\\_views/info\\_tech/hidden-environmental-benefits-cloud-computing](http://www.sustainablebrands.com/news_and_views/info_tech/hidden-environmental-benefits-cloud-computing) on 03/10/2013
- [5] Greenpeace International, Make IT Green, retrieved from <http://www.greenpeace.org/international/en/publications/reports/make-it-green-Cloudcomputing> on 6/10/2013
- [6] Rick Blaisdell, Why is Cloud Computing Green?, retrieved from <http://www.rickscloud.com/why-is-cloud-computing-green/> on 4/10/2013
- [7] Rivoire, S., Shah, M. A., Ranganathan, P., Kozyrakis, C., Joulesort: a Balanced Energy-Efficiency Benchmark, Proceedings of the 2007 ACM SIGMOD International Conference on Management of Data, NY, USA, 2007.
- [8] Saurabh, K. G., Rajkumar, B., Green Cloud Computing and Environmental Sustainability, Dept. of Computer Science and Software Engineering, The University of Melbourne, Australia, 2011.
- [9] Srikantaiah, S., Kansal, A., Zhao, F. 2008. Energy aware consolidation for Cloud computing. Proceedings of HotPower '08 Workshop on Power Aware computing and Systems, San Diego, CA, USA, 2008.



## SOURCES OF FUNDING FOR PROJECTS IN THE FIELD OF ENERGY EFFICIENCY AND RENEWABLE ENERGY SOURCES

**Dragan Pavlović, Milena Todorović, Peđa Milosavljević**  
University of Niš, Faculty of Mechanical Engineering, Niš  
e-mail: draganpavlovic10369@gmail.com

**Abstract:** This paper presents an overview of sources of funding and crediting the projects which promote energy efficiency and renewable energy sources and presents all necessary information, in one place, for all interested parties. The paper includes some of the funds and credit facilities that are available in the Republic of Serbia. Energy efficiency is becoming a priority since it helps reducing greenhouse gases emissions and allows a reliable energy supply with significant energy savings. Therefore, one of the most important priorities that are being pursued by the government is increasing energy efficiency, which also means savings in the use of energy, but also the promotion and increased use of renewable energy sources.

**Key words:** energy efficiency, renewable energy source, fund, credit facility

### INTRODUCTION

Energy consumption in the Republic of Serbia is at relatively high level, which is especially evident in the public and residential sectors. In order to protect the environment and to reduce climate changes, it is very important to use energy and energy resources rationally. The key measures of the rational use of energy are to increase the reliability of energy supply, reduce dependency of imported energy and to increase competitiveness and standard of living. These measures contribute preservation of environment and as such they are very important element of sustainable development.

Improving energy efficiency and increasing the use of renewable energy represents continuous process that requires an organized and systematic approach of relevant government institutions and community organizations, local governments, companies and individuals.

However, a lack of systematic incentive measures, complex administrative procedures and unenviable economic situation are the reasons that Serbia is still very energy intensive country. In recent years the number of energy efficiency projects that have been implemented in Serbia increased, as a result of different public, private and individual initiatives and increased awareness.

The aim of this paper is to present methods of funding, i.e. to present some of the funds and credit lines that are currently available in the Republic of Serbia for financing the projects in the field of energy efficiency and renewable energy sources.

### IMPORTANCE OF ENERGY EFFICIENCY

Investments in energy efficiency and projects that promote renewable energy sources, increasingly take place in thinking and planning of public and private sectors in the Republic of Serbia.

Energy efficiency is becoming a priority since it helps in reducing emission of greenhouse gas (GHG) and allows reliable energy supply with significant energy savings. Energy efficiency involves a series of measures taken to reduce energy consumption, which in fact does not have negative influence on the working and living conditions. The goal is to reduce energy consumption to minimum and maintain or increase the level of convenience and comfort. The results of increased efficiency in energy use are significant savings in terms of finance, but also better working and living environment. In order to increase energy efficiency in Serbia a set of systematic and well synchronized measures are necessary. There is number of strategic documents and its action plans aimed to contribute to this target.

Over the last decade, EU has extensively dealt with the energy sector, primarily from the strategic point, setting the framework and goals for future activities. The latest document in this area is adopted on 27th of March in 2013, entitled "Green Paper - A 2030 framework for climate change and energy policies" [3]. This document also confirms and determines the objectives of EU energy policy, taking

into account long term perspective, by three headline targets for GHG emission reductions, renewable energy and energy savings, known as the "20-20-20" objectives. These are:

- Reducing the GHG emissions in EU by at least 20 % compared to the level of in 1990,
- 20 % of EU energy consumption to be from renewable energy sources;
- 20 % reduction in primary energy usage, compared with projected levels, to be achieved by improving energy efficiency.

The estimations of the European Commission have shown that EU was on course to achieve only a half of the targeted 20 % of the reduction in primary energy usage compared with projected levels. This is the reason why the European Commission has developed a new comprehensive Energy Efficiency Plan 2011 (EEP 2011), which represents a significant potential for energy savings [1].

Also, EU is committed to reduce GHG emissions by 80-95 % compared to the level in 1990 for the period until 2050, in context of necessary reductions of the developed countries as a group [2]. Energy Roadmap 2050 (ERM 2050) is the basis for development of long-term European framework together with all stakeholders.

The greatest potential for energy savings still lies in buildings, which is confirmed by both above mentioned documents [1, 2]. Existing buildings are responsible for more than 40% of the world primary energy consumption, and the cause of about 24 % of global CO<sub>2</sub> emissions [1].

The basis for energy efficiency improvement in the Republic of Serbia is the first National Energy Efficiency Action Plan (NEEAP) for the period 2010-2012, which determines the middle indicative energy savings target for this period of 1.5% of final domestic consumption in the household sector, public and commercial sectors, industry and transportation [5]. The NEEAP was made based on the obligation of the Republic of Serbia that arise from the Energy Community Treaty [4] and the decision of the Ministerial Council of the Energy Community number 2009/05/MS-Enc, which the Republic of Serbia accepted the obligation to implement the Directive 2006/32/ES on energy efficiency in energy consumption.

In order to encourage responsible, rational and long-term sustainable use of energy the Republic of Serbia adopted, in March 2013, the Law on Efficient Energy Consumption (LEEC). This law regulates the terms and conditions of the efficient use of energy and energy sources in production sector, transmission, distribution and energy consumption; policy of efficient energy use; system of energy management; labeling of energy efficiency level of products that affect energy consumption; minimum requirements of energy efficiency in production, transmission and distribution of electricity and thermal energy and natural gas delivery; financing, incentives and other measures in this area, and other issues relevant for the rights and obligations of individuals and legal entities. The LEEC goes toward the strategic plan and the international obligation of Serbia to save at least 9% of gross final energy consumption up to 2018, and to reduce GHG emission by approximately 9% until 2030 [6].

## TYPES OF FUNDING

This part of the paper considers some of the funds and credit facilities available in the Republic of Serbia for financing projects in the field of energy efficiency and utilization of renewable energy sources.

EU assistance to the energy sector in Serbia in the past period has been enormous. EU funds that are made available for projects of energy efficiency and using renewable energy sources are available through various EU programs for pre-accession assistance. EU allocates significant resources from common budget to help less developed regions and its member states. However, certain funds for development EU gives to the states that are not its members, as well as the candidate states, potential candidate and to developing states.

For all local and regional authorities in the Republic of Serbia, for the financing the projects dealing with renewable energy sources and energy efficiency, is available the **Instrument for Pre-Accession Assistance (IPA)** [8]. The main goal of IPA Programme is to help the candidate countries and potential candidate countries to harmonize their legislation with the EU acquires and to prepare for the use of structural funds. IPA funds are grants of development assistance, intended to reform policies and development projects that create the conditions for Serbia approaching to EU, as well as a potential candidate country for EU membership. For all projects and activities funded by the IPA the Republic of Serbia must also provide a proportionate share of funds.

The mission of the **Green for Growth Fund, Southeast Europe (GGF)** is to contribute, in the form of public-private partnerships, to improve energy efficiency and promote the use of renewable energy sources in the region of Southeast Europe, primarily through purposeful funding to economy and households through partnerships with financial institutions or by direct financing [9]. GGF was launched by the European Investment Bank and the German Development Bank (KfW- KfW Entwicklungsbank). GGF also provides an opportunity to help the projects through technical assistance, which may include feasibility studies, project documentation, and so on. The Fund was established as public-private partnership.

One of the programs that have existed up to this year is the **Program for Competitiveness and Innovation (CIP)**. CIP program for the period 2007-2013, was divided into three operational programs, of which the **Intelligent Energy for Europe (IEE)** program covering the area of environmental protection and energy efficiency [10]. The main objectives of the IEE program are the following:

- To increase energy efficiency and the rational use of energy resources;
- To promote new and renewable energy sources and encourage the diversity of energy sources;
- To promote energy efficiency and use of new and renewable energy sources in transport.

The new program for **Competitiveness of Enterprises and Small and Medium-sized Enterprises (COSME)**, who will replace CIP, will last from 2014 to 2020 [11].

**European Bank for Reconstruction and Development (EBRD)** established in the 2008th as a special fund called the **Western Balkans Sustainable Energy Direct Financing Facility (WeBSEDF)** aimed for financing projects of sustainable energy development in the Western Balkans [12]. This credit line is intended for local small and medium enterprises (SMEs) and investors who wish to invest in energy efficiency projects in industry or the utilization of renewable energy sources [7]. In addition to the financial assistance the EBRD provides expert advisory and technical assistance. All projects funded under WeBSEDF fund must comply with the energy policy of the Republic of Serbia and in accordance with specific standards related to energy efficiency and the requirements relating to the protection of the environment. So far, 16 projects financed by this fund were implemented in Serbia.

Another program that will end this year is **Seventh Framework Programme (FP7)**, which lasted seven years, from January 2007 to the end of 2013.

FP7 was the EU's main instrument for funding scientific researches and development, and activities included organization of cooperation between universities, research centers and industry (including SMEs), as well as providing financial support for joint projects.

A successor of FP7 program, for the period 2014-2020, is called the **Horizon 2020 program**. Horizon 2020 is the new EU financial instrument for the development of research and innovations. The goal of this program is to increase the level of improvement of the European scientific base and ensure safe flow of global research activities and thus ensure a long-term European competitiveness [13].

**SEE (South East Europe) Transnational Cooperation Program** is a unique instrument, which in the framework of regional policy and territorial cooperation aims to improve the integration and competitiveness in the area that is complex and diverse [14]. The program supports projects developed within four Priority Axes: Innovation, Environment, Accessibility and Sustainable Growth Areas - in line with the Lisbon and Gothenburg priorities, and also contributes to the integration of non-EU countries. Priority axis Environment includes projects in the areas of energy efficiency and renewable energy sources.

Since 2007, the **German Agency for Technical Cooperation (Gesellschaft für Internationale Zusammenarbeit - GIZ)** has established a new instrument, the **Open Regional Fund for South East Europe**, to finance regional development projects [15]. GIZ projects are often oriented towards achieving the technical requirements in local governments so that they itself applying for projects financed by EU funds, or to work in partnership with other local governments.

Within the Open Regional Fund for South East Europe operate four different funds, and one of them is the Open Regional Fund for Energy Efficiency and Renewable Energy Sources for South-East Europe. The goal of the Open Regional Fund for Energy Efficiency and Renewable Energy Sources for South East Europe is projects funding for the security of energy supply in South East Europe through more efficient energy consumption and increased the use of renewable energy sources.

In the Republic of Serbia, there are several credit lines intended primarily for SMEs for the implementation of projects dealing with energy efficiency and renewable energy sources. The following are some basic information about credit lines.

First of all, it must be mentioned the international financial institutions, especially the **World Bank Group**. The World Bank is an international financial institution that provides low-interest loans, interest-free credits and grants to developing countries around the world, and in Republic of Serbia finance a number of projects in the area of energy efficiency [16]. So far, the World Bank funded projects in Serbia by providing grants and credit conditions that are, according to its rules, available to the poorest countries in the world called "Soft" loans, under IDA - International Development Association conditions, with long repayment periods and low interest rates. However, since last year the projects in Serbia, are also financed by **IBRD** conditions (International Bank for Reconstruction and Development), intended to the countries that are on the middle level of income and are less creditworthy, in order to promote sustainability, equity, increase employment, reduce poverty and resolving other regional and global issues. IBRD achieves its goals by crediting the projects that are important for the national economy, for which the private capital is not interested, since the value of investments and the risk are high.

The banks in Serbia also follow the trends and according to key issues at certain times they introduce new things in their offer. Currently, especially popular types of loans are loans for energy efficiency. Some of the banks have already taken active participation in the financing of projects in the field of energy efficiency and renewable energy sources. The purpose of these loans can be for:

- Replacement of exterior doors and windows;
- For insulation;
- Installation of energy-efficient furnaces and boilers;
- Installation of heat pumps;
- Installation of equipment for biomass combustion;
- Installation of solar panels, etc.

Below is a list of banks that have in offer loans for projects dealing with energy efficiency and renewable energy sources:

- Banca Intesa;
- Bank "Čačanska banka";
- Hypo Alpe-Adria Bank;
- NLB Bank;
- Societe Generale Bank;
- Volksbank;
- UniCredit Bank;
- Raiffeisen Bank;
- Commercial Bank;
- Eurobank EFG;
- Erste Bank;
- OTP Bank;
- ProCredit Bank.

It should be noted that in addition to the above mentioned financing sources, the Republic of Serbia participate in the funding of almost all projects, through its ministries and local authorities. Besides the state the projects were co-financed through individual initiatives, public-private partnership, through various associations from individuals to the private sector etc. Very often the state or local partners co-financing is pre-condition for approval of financing certain projects.

The Republic of Serbia has decided to establish the Energy Efficiency Fund, which starts in 2014. Funds from this budget fund, either directly or indirectly - through banks will be able to use, not only citizens and businesses sector, but also various institutions and organizations that want to improve their energy efficiency and thereby achieve savings.

## CONCLUSION

The European Community encourages local initiative in the field of sustainable development, including policies on energy efficiency and use of renewable energy sources. Energy efficiency and renewable energy sources become a priority since it allows reducing of GHG and secure energy supply with significant energy savings.

The basic motivation for the implementation of projects dealing with energy efficiency and renewable energy sources is financial profitability of projects. Reduction in energy consumption or use of cheaper energy sources provides significant financial savings, which would be if the project is viable, that within a reasonable period exceed investment in the project, as well as operation and maintenance costs of the system and make adequate income.

## REFERENCES

- [1] EU Commission, Energy Efficiency Plan 2011, 2011.
- [2] EU Commission, Energy Roadmap 2050, 2011.
- [3] EU Commission, Green paper – A 2030 framework for climate change and energy policies, 2013.
- [4] The Government of the Republic of Serbia, Contract on Founding of the Energy Community. Official-Gazette of RS, No.62/06, 2006.
- [5] The Government of the Republic of Serbia, The First National Energy Efficiency Action Plan of Republic of Serbia for the period 2010 to 2012, 2010.
- [6] The Government of the Republic of Serbia, The law on the Efficient Energy Consumption. Official-Gazette of RS, No.25/13, 2013.
- [7] USAID Serbia Competitiveness Project, Inventory of Existing Credit Facilities of International Financial Institutions for Renewable Energy and Energy Efficiency Projects in Serbia, 1-38, 2009.
- [8] [http://ec.europa.eu/regional\\_policy/thefunds/ipa/crossborder\\_en.cfm](http://ec.europa.eu/regional_policy/thefunds/ipa/crossborder_en.cfm)
- [9] <http://www.ggf.lu/>
- [10] <http://ec.europa.eu/cip/>
- [11] [http://ec.europa.eu/cip/cosme/index\\_en.htm](http://ec.europa.eu/cip/cosme/index_en.htm)
- [12] <http://www.websedff.com/>
- [13] [http://ec.europa.eu/research/horizon2020/index\\_en.cfm](http://ec.europa.eu/research/horizon2020/index_en.cfm)
- [14] <http://www.southeast-europe.net>
- [15] <http://www.giz.de/Themen/en/34041.htm>
- [16] <http://www.worldbank.org>

## TEMPERATURE CHARACTERISTICS OF MASSIVE SOLAR WALLS

Miroslav Lambić<sup>1</sup>, Novica Pavlović<sup>2</sup>

<sup>1</sup>University of Novi Sad, Technical Faculty "Mihajlo Pupin", Zrenjanin, Serbia

<sup>2</sup>Higher School of Professional Business Studies, Novi Sad, Serbia

e-mail: [lambic@ptt.rs](mailto:lambic@ptt.rs)

**Abstract:** In this paper are given the temperature characteristics of massive ("passive" and "active") solar walls. Tests program included measuring of distinctive temperatures at the time when the fan ran (during daytime/sun shining) and at the time when the fan did not run (at the time when the absorbing wall surface was not being shone - on day and night). The results of this experimental testing, as well as the previous ones point out the better temperature effects of the "active" walls in relation to the "passive" ones.

### INTRODUCTION - EXPERIMENT

Comparative testing of massive - "passive" and "active" (with the central duct - chamber) solar walls with aim to the distinctive temperatures (their relation) was performed when in a certain period during the day was running a fan at the wall model with the inner duct - hollow space ("active" walls).

Back wall side is thermo-insolated with a mineral wall layer, 50 mm thick, of the next characteristics:

$$\rho = 27,0 \text{ kg/m}^3; \lambda = 0,037 \text{ W/mK (at } 0 \text{ }^\circ\text{C)}.$$

For the forced air circulation was used a radial fan of the next characteristics:

- diameter of the fan rotor: 60 mm,
- length of the set: 180 mm,
- power: 20 W,
- number of revolutions: 1450 min<sup>-1</sup>
- capacity: 30 lit./s

Tests program included measuring of distinctive temperatures at the time when the fan ran (during daytime/sun shining) and at the time when the fan did not run (at the time when the absorbing wall surface was not being shone - on day and night). The moveable key 3 (Fig. 1) was in the opened position during the fan running (the opened inlet duct in the central hollow space - 1), and the air freely circulated from the entering zone into the central duct - the chamber. During the ceasing of fan work, the key was put into the closed position, i.e into the position of closing the upper entering aperture leading into the central wall chamber.

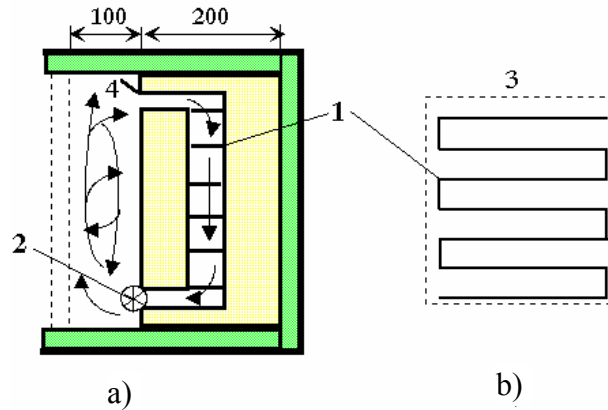
In this experiment testing of both types of massive walls is performed, and in the central duct of "active" wall is fixed a mechanical obstacle (pos. 1) that prevents free air circulation through it (Figure 1). That obstacle is specially formed of steel plate (the resistor to the air flow) with air gaps between the surface of the duct walls and the edges of the resistor - the figure 1 - b. Free cross-section of the central chamber where air could directly circulate (the part of the cross-section where there was not a mechanical obstacle) was 25 % of the total cross-section surface.

The fan (2) was during the testing a certain period of time at work (daily - mostly at the direct sun radiation action) and the rest of time in 24 - hours period - switched off (in the evening and at night).

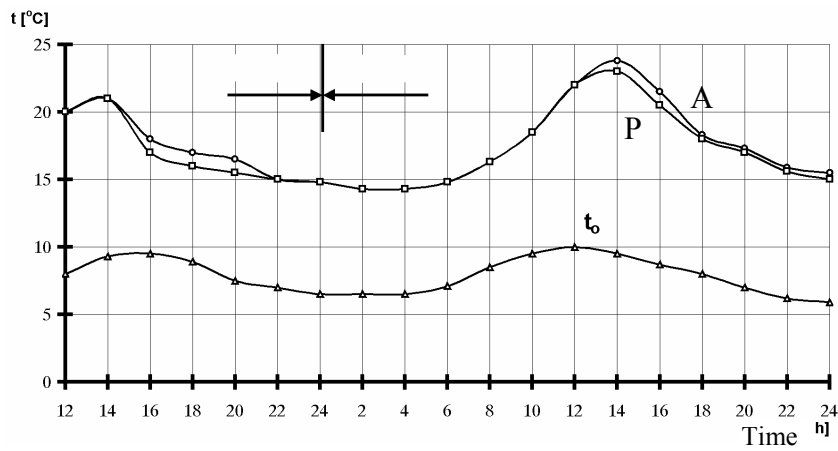
During the (time) period the fan ran, on account of such prevented full circulation, there happened, to a certain degree air whirling in the entering zone - between the transparent and the absorbing wall surface.

### Temperature characteristics

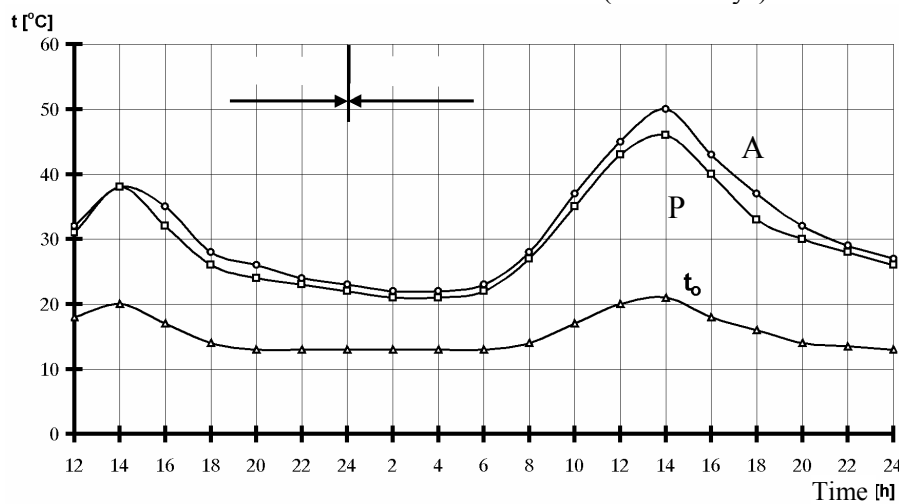
In the figures 2 to 4, is presented the diagram (for several days) measuring results of the ambient temperature ( $T_0$ ), the transparent medium temperatures ( $T_s$ ), the medium air temperatures in the entering zone - between the transparent and the absorbing wall surface ( $T_z$ ) - for both tested types of the massive walls.



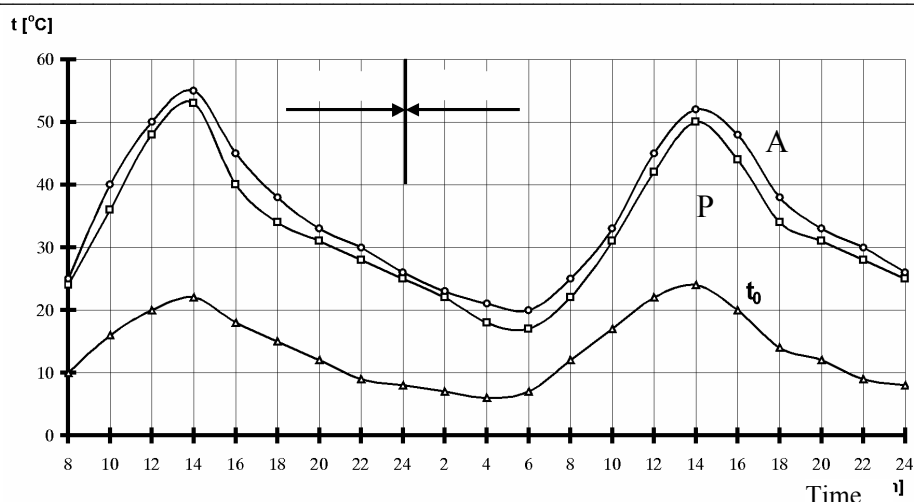
**Figure 1.** Massive “active” wall with forced circulation and the mechanical resistor to the air flow (1- resistor to the air flow, 2- fan, 3- the central duct-chamber, 4 - moveable key)



**Figure 2.** Comparative survey of curves of temperature changes for the outside glass covers “passive” (P) and “active” (A) massive wall when fan runs during daytime and when resistor to air flow is fixed in the central duct (for two days)



**Figure 3.** Comparative survey of curves of the air temperature changes at the entering zone at “passive” (P) and “active” (A) massive walls when the fan runs during control duct



**Figure 4.** Comparative survey of curves of temperature changes at the entering zone at "passive" (P) and "active" (A) massive walls when fan runs during daytime and when resistor to the air flow is fixed in the control duct

## CONCLUSIONS

The results of this experimental testing, as well as the previous ones point out the better temperature effects of the "active" walls in relation to the "passive" ones. The higher temperature of the "active" wall back surface is better from the exploitation aspect, taking into consideration that surface is in contact with the heated room. Fixing an integral collector of the solar energy to the collecting side of the massive wall, heat losses to the outside environment are reduced from the heated room and the massive wall.

At "active" massive walls the inner duct-chamber is filled with material of good heat accumulating characteristics. The filling structure offers as less as possible resistance to the air circulation and the surface in contact with the air flow is larger. The relation of the material filling surface is in direct function with the foreseen heating time for those pieces, along their depth.

The filling material can be made of homogenous material with appropriate duct system that enable uniform contact of hot air along the whole filling or from the loose material of different size-granulation (gravel or others). The size of the used granulate enables the location of larger mass in determined volume and larger contact surface for heat exchanging. Meanwhile, resistance to the air flow are greater and it requires a stronger fan and higher plant costs of electrical energy. Uniform airflow distribution is then more difficult, so one must make a combination of homogenous and loose material. A homogenous material may be any perforated plate (metal or other) so that granulates can not fall through it, and there is a free passage for the air flow.

The fixing of the regular system of the air flow distribution, the granulates of the filling and the duct system schedule undergoes optimisation considering.

## REFERENCES

- [1] Lambić, M., Solarne instalacije i objekti, Društvo za sunčevu energiju "Srbija solar", 2004.
- [2] Lambić, M.; Pavlović, T.; Tolmač, D.; Pavlović, M.; Prvulović, S.; Pavlović, N.; Pekez, J.; Milosavljević, D.: Studija o proceni ukupnog solarnog potencijala - Solarni atlas i mogućnosti "proizvodnje" i korišćenja solarne energije na teritoriji AP Vojvodine, Izvršno veće AP Vojvodine, Pokrajinski sekretarijat za energetiku i min. sirovine, Novi Sad, 2011.
- [3] Pavlović, T.; Milosavljević, D.; Mirjanić, D.: Obnovljivi izvori energije, Akademija nauka i umjetnosti Republike Srpske, Banja Luka, 2013.
- [4] Lambić, M.: Solarne tehnologije, SGM knjiga, Beograd, 2013.
- [5] Lambić, M.: Solar Walls, University of Novi Sad, Technical Faculty "Mihajlo Pupin", Zrenjanin, 1999.



## IMPROVING PERFORMANCE IN THE POWER OF DRIVE WITH ELECTROMAGNETIC VIBRATORY FEEDER

Željko Despotović<sup>1</sup>, Vladimir Šinik<sup>2</sup>

<sup>1</sup>Institute Mihajlo Pupin, Belgrade, Serbia

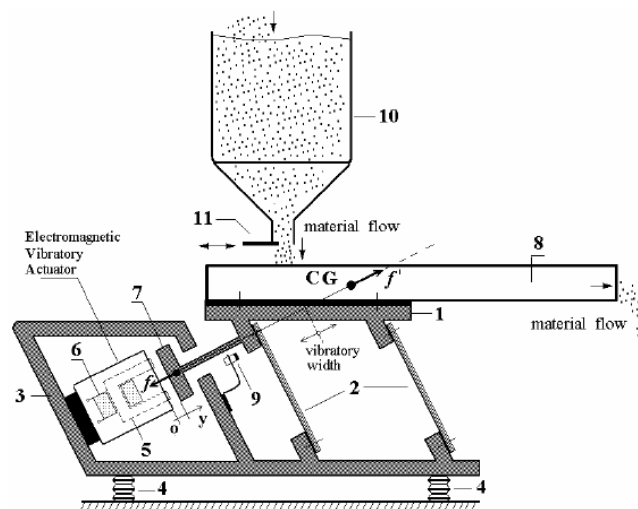
<sup>2</sup>University of Novi Sad, Technical Faculty “Mihajlo Pupin”, Zrenjanin, Serbia  
sinik.vladimir@gmail.com

**Abstract:** In this paper will be proposed solutions for a transistor converter for electromagnetic vibrators. These electromagnetic vibrators are used in dose and heave systems for scraped material. Earlier standard solution with thyristors and triacs are with phase angle control. This type of converter have poor power factor and they produce a harmful harmonics in the main power network. The new class converter now works in pulse domain and they have power factor correction and also the possibility to eliminate a harmful harmonics.

**Key words:** Electromagnetic vibrator, transistor converter

### INTRODUCTION

The vibratory conveyors are widely used device in various technological processes for transporting and finishing materials. Conveying process is based on a sequential throw movement of particles. Vibrations of tank, i.e. of a “load-carrying element” (LCE), in which the material is placed, induces the movement of material particles, so that they resemble to a highly viscous liquid and the material becomes easier for conveying. In the processing industry are often used mechanisms based on the vibratory conveyors with electromagnetic drive. Vibratory conveying drives with electromagnetic vibratory actuator (EVA) are a very popular because of their high efficiency and easy maintenance [1], [2].



**Figure 1.** Typical construction of vibratory conveyer with electromagnetic drive

A typical arrangement of electromagnetic vibratory conveying drive (EVCD) can be seen in Fig.1. Its main components are *LCE*-1, *EVA* as source of excitation force and *flexible elements*-2. Flexible elements are made of composite leaf springs. These elements are rigidly connected to the *base*-3, which is resting on *rubber pads*-4 to the foundation. *Magnetic core*-5 is covered by continuous *winding coils*- 6. Electromagnetic force acts on *armature*-7 attached to the LCE. This element carries the *vibratory trough*-8 along with transporting material. The vibratory displacement is measured by non-contact *inductive sensor*- 9. The granular material comes to the trough from *storage hopper*- 10. Input flow is adjusted by *movable shutter*- 11. *f*

Application of electromagnetic vibratory drive in combination with power converter provides flexibility during work. It is possible to provide operation of the vibratory drive in the region of the mechanical resonance. Resonance is highly efficient, because large output displacement is provided by

small input power. In this way, the whole conveying system has a behavior of the controllable mechanical oscillator [3], [4]. SCR converters are used for the EVA standard power output stage. Their usage implies a phase angle control [4-6]. Firing angle varying provides the controlled AC or DC injection current of EVA or controls his mechanical force. This force is squared function of current in EVA winding coils [3], [5].

### TYPES OF VIBRATORY CONVEYING SYSTEMS

Electromagnetic VCS are divided into two types: single-drive and multi-drive. The single-drive systems can be one-, two- and three-mass; the multiple-drive systems can be one- or multiple-mass as shown in Fig. 2. Description of one-mass system is shown in Fig 2 (a). It comprises following elements: *LCE*, with which the *active section* of the EVA is connected, *elastic element*, connecting the active section with the *reactive section*, having been fastened on the frame.

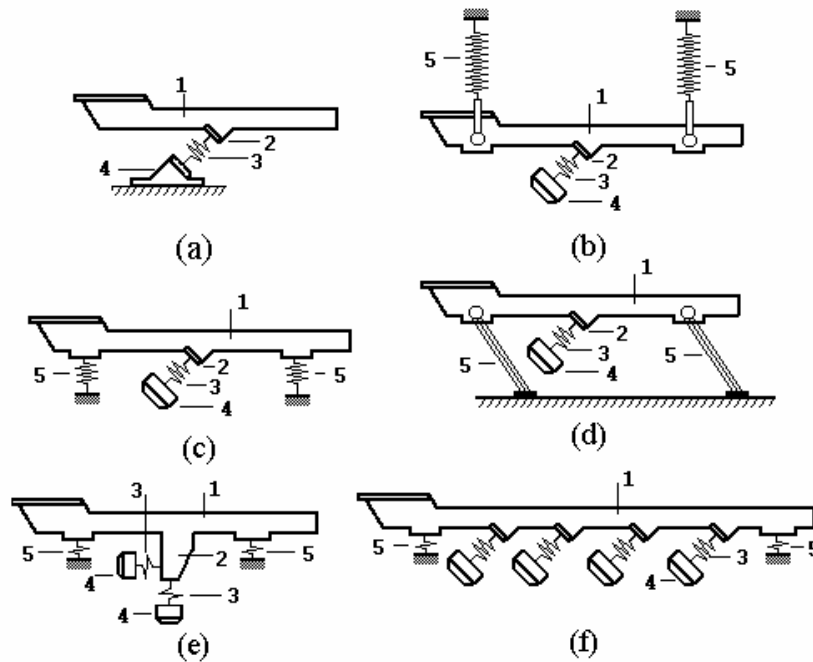
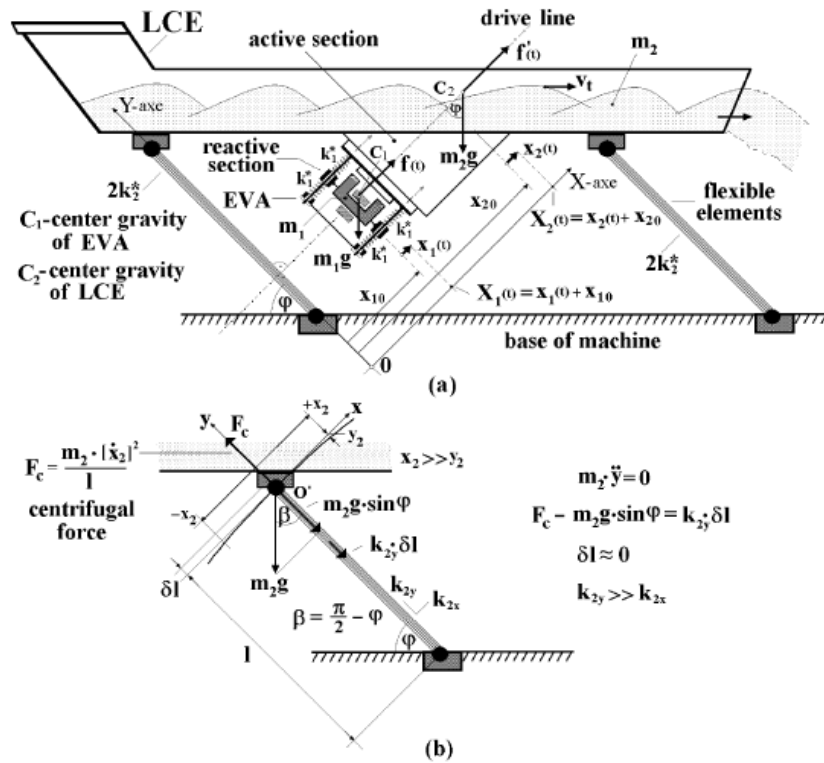


Figure 2. VCS with electromagnetic drives

The main components of the two-mass systems are shown in Fig. 2 (b): *LCE*, to which the active section of EVA is attached, comprising *active section* and *reactive section*, with built-in *elastic connection*. The vibratory machine base is separated from the load-carrying structure by means of *plate springs*. A special drive, comprising two identical actuators, which oscillate in mutually perpendicular directions like in

Fig. 2(c), is used for elliptical oscillation. The multiple-drive multiple-mass system as shown in Fig.2 (d), has a *LCE* on which a number of identical actuators with *elastic connections* are tied.

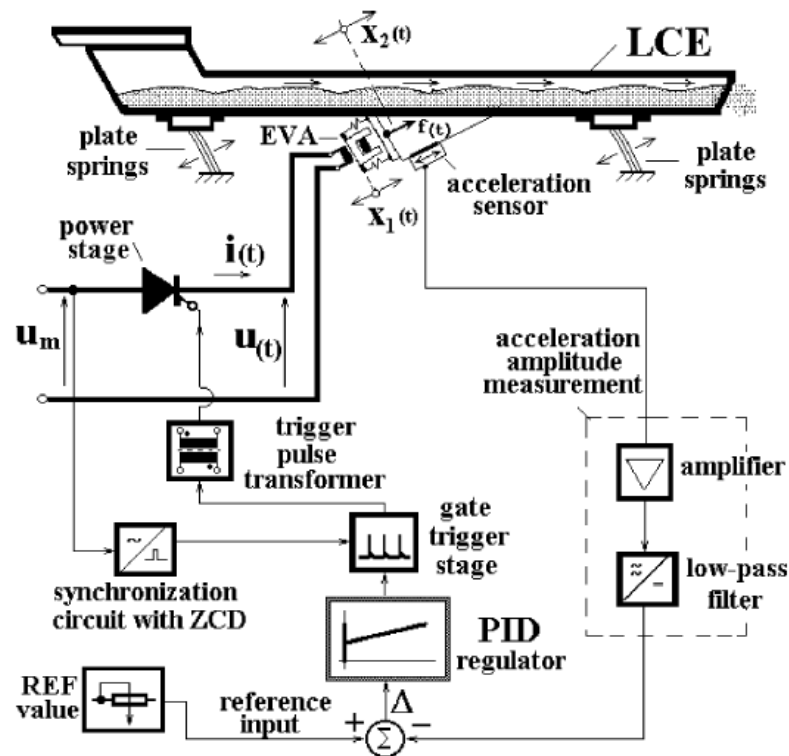
A description of one type single-drive two-mass electromagnetic vibratory conveyor is shown in Fig. 3(a). Its main components are the *LCE*, to which the active section of the EVA is attached, comprising an *active section* and *reactive section*, with built-in *elastic connection*. Flexible elements, by which the *LCE* with material is supported, are composed of several leaf springs, i.e., *plate springs*. These elements are rigidly connected with the *LCE* on their one side, while on the other side, they are fitted to the base of the machine and sloped down under angle .



**Figure 3.** Two-mass vibratory conveyor with plate springs. (a) Electromechanical model. (b) Static equilibrium forces in y-direction.

### SCR POWER CONVERTER IN RVCD

In regulated vibratory conveying drives (RVCD), thyristors and triacs are today employed as standard elements of output power stages. Basic topologies of the power converters of this type are shown in Fig.4. Their use implies adjustment of vibratory displacement and vibratory velocity of the LCE by using phase angle control.



**Figure 4.** SCR topology for exciting of electromagnetic vibratory conveying drives

One type of these converters realized by using only one thyristor i.e. *unidirectional*, are characterized by a pulsating output current, makes use only one half-period of the network voltage. In this type of converter the thyristor is triggered only during positive half-periods. In this way the network voltage of frequency 50(60) Hz at the input is converted to a pulsating direct current (DC) supplying the coil of the EVA which generates a discrete spectrum of vibrations: 3000 (3600) cycles/min, 1500(1800) cycles/min, 1000(1200) cycles/min, 750(900) cycles/min, 600(720) cycles/min, 500(600) cycles/min, etc., depending upon the instant of triggering of the thyristor.

A serious problem arises when the mass of the conveying material is changed, i.e. mechanical resonance of the system has changed. In such case the vibratory system will not operate efficiently. It is possible to tune amplitude but not the frequency of the vibrations. In addition, the thyristor converter brings in a DC component and undesirable higher harmonics. Application of triacs results in somewhat better situation as regards the harmonic content, but the same problem arises if the resonant frequency is changed. Variation of the mechanical resonance due to variation of the mass of the conveyed material, or even variation of the system parameters (characteristics of the springs, damping, etc.), leads to reduction of efficiency of the RVC. In order to accomplish an optimal and efficient operation at a new resonant frequency, it is necessary to change the frequency of EVA supply current, i.e. of the excitation force of the vibratory conveyor.

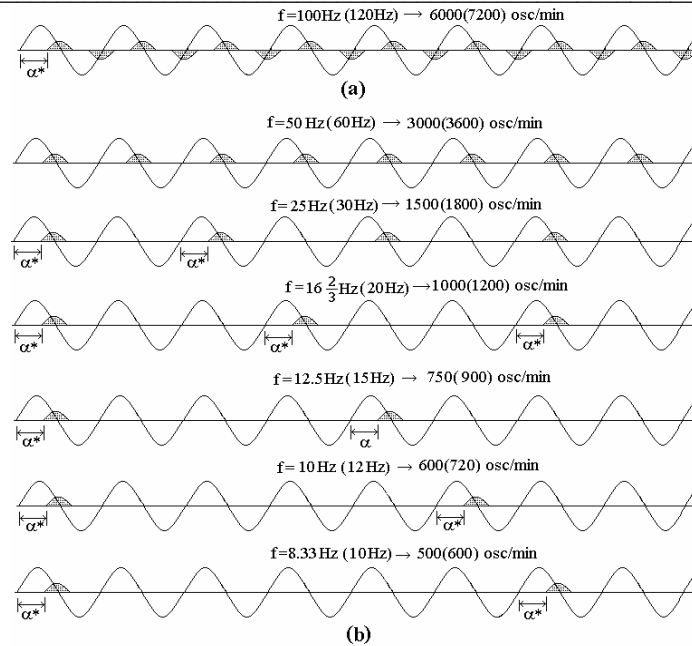


Figure 5. Characteristic waveforms in case of phase control.

In this case thyristor firing is achieved only in positive half wave as shown in Fig.5 (a). The output voltage (50Hz or 60Hz) is converted to pulsating DC current of EVA i.e. pulsating force of EVCD. In this way, generate vibrations of discrete spectrum like in Fig.5, depending on the moment of thyristor firing.

With these power converters is the mains frequency 50Hz/60Hz converted to AC power supplied to the same frequency coil EVA as shown in Fig.5(b).

### SWITCH MODE POWER CONVERTERS IN RVCD

Today, a great deal of work is done on implementing switch mode power converters (SMPC) for obtaining sinusoidal or triangle current pulses in the EVA [6]. Application of SMPC enables accomplishing the amplitude and/or frequency control of vibratory conveying. The use of SMPC makes the excitation of a resonant conveyor independent of the supply network frequency. The frequency control ensures operation in the region of mechanical resonance. As in the case of SCR one can talk about unidirectional and bidirectional converter types, depending on whether there was DC pulsating or AC excitation of EVA. The generally accepted mechanical construction of resonant vibratory conveying drive and driving switching circuits are shown in Fig.6.

The topology consisting of two switches and two return diodes is used in designing the unidirectional type of converters, i.e. the asymmetric half-bridge as shown in Fig. 6(a), while the full-bridge and half-bridge topologies are used for designing the bidirectional type of converters, as shown in Fig.6(b) and Fig.6(c), respectively. The required sine-wave (half-wave) can be realized by these topologies if the applied current control is based on tracking the reference sine-wave of adjustable length, amplitude, and frequency. This method of generation of the excitation current has the advantage in that it allows independent tuning of the frequency and amplitude of the electromagnetic excitation force  $F$ .

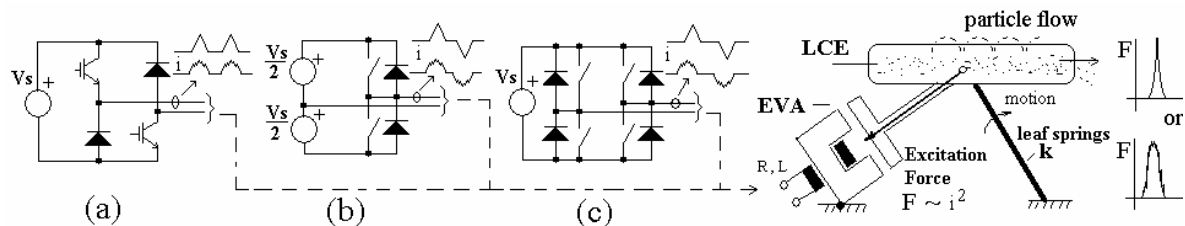


Figure 6. SMPC topologies for exciting of electromagnetic vibratory conveying drives; (a)- asymmetrical half bridge, (b)- symmetrical half bridge and (c)-full bridge

In this paper the considerations will be focused on the electromagnetic drives having asymmetrical switching topology shown in Fig.6(a). The switching converter described in [7], despite its advantages, suffers from a serious shortcoming that at high frequencies its switching losses become dominant. In addition to these losses, the losses in iron of the magnetic circuit and in copper of EVA coil become also significant. This reduces the efficiency of the vibratory conveyor and it is not unusual that the power of losses in the system converter-EVA-vibratory drive is higher than the power required for maintaining the resonant oscillatory mode. This reduces considerably the efficiency of the drive as a whole. By a suitable switch-mode current control in this topology and generating triangle waveform of EVA current, it is possible to overcome this problem and accomplish the expected vibratory effect, i.e. the required amplitude of LCE oscillations and optimal operating frequency of the vibratory conveyor. However, irrespective of the pulse excitation of LCE, the output displacement is a “smooth” sinusoid, as a consequence of the character of the mechanical part of the system, which, attenuates higher harmonics, as shown in [6]. Despite many advantages, previously described switch mode RVCD under certain conditions can have negative influence on the supply network. In the remainder of this paper will be analyzed in a number of specific cases which express the negative effects mentioned topology to the supply network.

### PFC CONVERTER FOR SUPPLYING RVCD

Block diagram for implemented AC/DC transistor converter is shown in Fig. 7. The transistor converter comprises two power converters. One is input AC/DC converter with power factor correction, while the other one is DC/DC (pulsating current) converter for driving EVA. Input converter is in fact a controllable transistor rectifier with two “boost” stages (M1-D3 and M2-D4) and inductance  $L_{in}$  on the AC side. This converter with advantages over the conventional power factor corrector (diode bridge rectifier-power switch-diode-inductance on DC side) is described in detail, in [6-7].

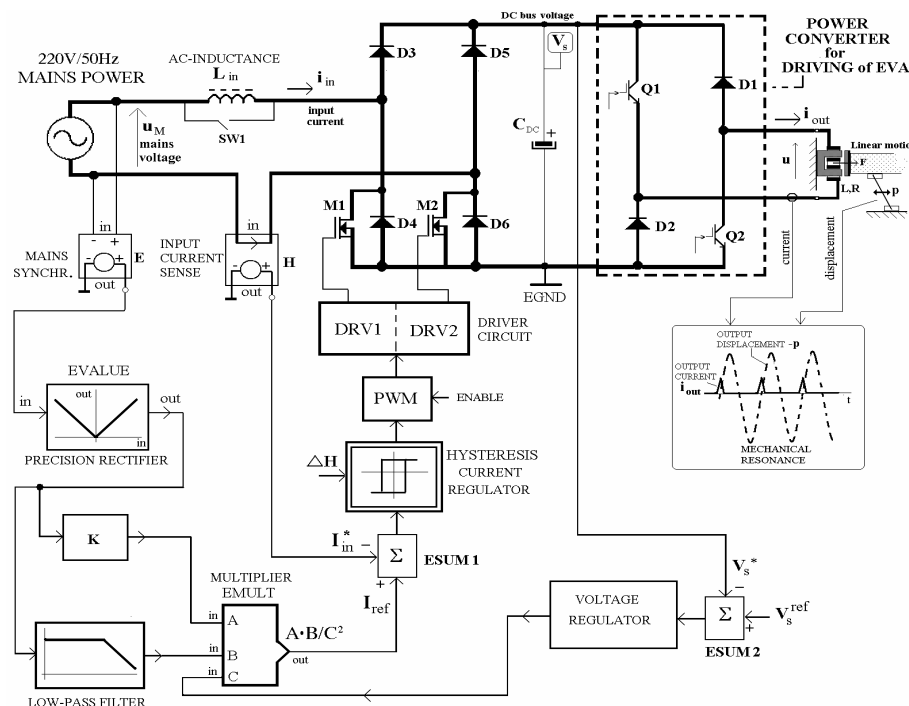


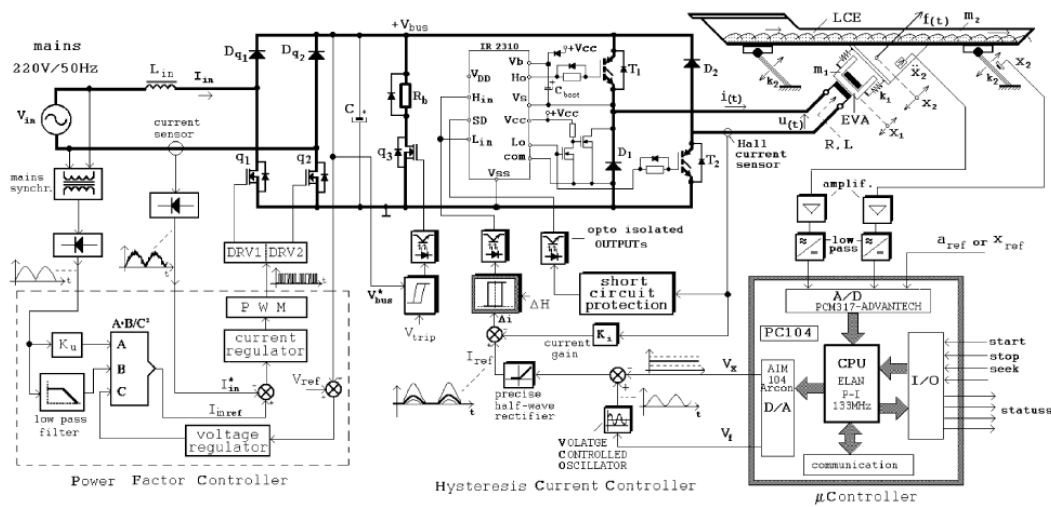
Figure 7. Principle block scheme of PFC control circuit for supplying switch mode RVCD

The basic functional block in the PFC control circuit is a hysteresis controller. The controller has the ability to adjust the width of the hysteresis  $\Delta H$ . To the input of a hysteresis controller is error signal i.e. the difference of two signals  $I_{in}$  and  $I_{ref}$ . The controller output is brought to the PWM circuit that has the implemented function ENABLE or DISABLE. The signal  $I_{in}$  is in fact the actual value of network

current, while the  $I_{ref}$  is signal from the output of multiplier  $AB/C^2$ . Input A of multiplier is signal which is obtained by measuring and rectifying of the input mains voltage  $U_m$ . Input B is filtered mains voltage, while input C is output of voltage controller (PI regulator).

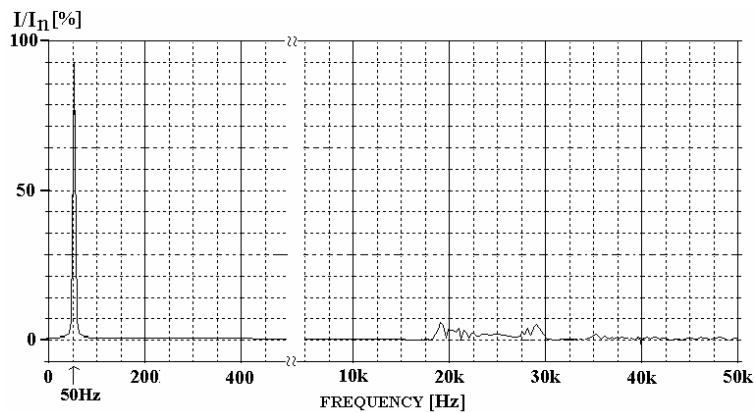
When the switch S1 is a *turned on* and when the signal ENABLE = "0", the entire system can be easily reconfigured in the basic circuit without PFC. In fact, the experimental results obtained for both of configurations.

A block diagram for implemented ac/dc transistor converter is shown in Fig. 8. The diagram is utilized for observance of the VCS behavior according to conveying mass change. The transistor converter comprises two power converters. One is an input ac/dc converter with a power factor correction (PFC), while the other one is a dc/dc (pulsating current) converter for driving EVA. The input converter is in fact a controllable transistor rectifier with two "boost" stages and inductance on the ac side. This converter with advantages over the conventional power factor corrector (diode bridge rectifier-power switch-diode-inductance on the dc side).



**Figure 8.** Principal diagram of implemented ac/dc transistor converter for driving of EVA

Fig.9 presents the FFT spectrum of the input current of RVCD with PFC converter, for the case when the driving frequency of EVA is equal 48Hz. In this spectrum are clearly observed dominant fundamental harmonic of 50Hz and two less dominant harmonics 18 kHz and 28 kHz.



**Figure 9.** Input current FFT spectrum of PFC converter of RVCD for EVA driving frequency of 48Hz

The last two harmonics are the result of implemented hysteresis regulation in PFC circuit. These harmonics have very small impact on the power supply network.

## CONCLUSIONS

In regulated vibratory conveying drives the thyristors and triacs are today employed as standard elements of output power stages. Their use implies adjustment of vibratory displacement and vibratory velocity of the load-carrying element by using phase angle control. The spectrum of the input current, in addition to a DC component, contains both lower and higher harmonics relative to the main component of 50Hz. The spectral composition in this case is very dependent on the spectrum of vibrations. Today, a great deal of work is done on implementing switch mode power converters for obtaining sinusoidal or triangle current pulses in the electromagnetic vibratory actuator. Application of switch mode power converters enables accomplishing the amplitude and/or frequency control of vibratory conveying. The use of switch mode power converters makes the excitation of a resonant conveyor independent of the supply network frequency. For this reason it is necessary to carry out an additional optimization of a switch mode i.e. optimization of the input (AC/DC) rectifying circuit. In the paper is proposed a solution to the power factor correction circuit, which provides a sinusoidal input current.

## REFERENCES

- [1] H.G.Cock, "Vibratory Feeders"-PHILIPS Technical Review, Vol.24, May 1975,pp.84-95.
- [2] P.U.Frei, "An Intelligent Vibratory Conveyor for the Individual Object Transportation in Two Dimensions", Proceedings of the 2002 IEEE/RSJ, Intl. Conference on Intelligent Robots and Systems, EPFL, Lausanne, Switzerland, October 2002, pp.1832-1837.
- [3] Z.Despotovic and Z.Stojiljkovic, "Power Converter Control Circuits for Two-Mass Vibratory Conveying System with Electromagnetic Drive: Simulations and Experimental Results", IEEE Transaction on Industrial Electronics, Vol.54, Issue I, Februar 2007,pp.453-466.
- [4] T.Do, K.Yoshida, Y.Tamai, K.Kono, K.Naito, T.Ono, "Modeling and Feedback Control for Vibratory Feeder of Electromagnetic Type", Journal of Robotics and Mechatronics, Vol.11, No.5, June 1999, pp. 563-572.
- [5] N.Barjamović,"Tiristori u sistemima za doziranje rasutih materijala", II simpozijum Energetska elektronika – Ee '75, Beograd (YU), Oktobar 1975, pp.334-348 Vibration Feeder, JSME International Journal, Series C, Vol.44, No.1, 2001, pp. 44-52.
- [6] Ž. V. Despotović, A. I. Ribić, V.Sinik, Power Current Control of a Resonant Vibratory Conveyor Having Electromagnetic Drive, Journal of Power Electronics, Vol.12, No4, July 2012.
- [7] Z.Despotovic and Z.Stojiljkovic, Power Converter Control Circuits for Two-Mass Vibratory Conveying System with Electromagnetic Drive: Simulations and Experimental Results, IEEE Transaction on Industrial Electronics, Vol.54, Issue I, February 2007, pp.453-466.



## **SESSION 11: Student papers**

## THE IMPORTANCE OF INTELLIGENT TRANSPORTATION SYSTEMS IN TRAFFIC

Svetlana Dobrosavljev, Slavica Prvulović

University of Novi Sad, Technical faculty „Mihajlo Pupin“ Zrenjanin, Serbia

e-mail: [UUprvulovic@tfzr.uns.ac.rs](mailto:UUprvulovic@tfzr.uns.ac.rs)

**Abstract:** Transportation experts agree that the beginning of the 21st century is characterized by directed activities for successful solving of growing problems of traffic and transport performance. These activities can no longer be applied without the use of comprehensive concept and technology of ITS (Intelligent Transportation Systems).

**Keywords:** intelligent transportation systems, traffic, transport infrastructure,

### INTRODUCTION

Transportation management includes planning, monitoring and controlling of traffic. It aims to: increase effectiveness by using the existing infrastructure, provide reliable and safe traffic, to make reference to the economic goals and to make proper arrangement of infrastructure (roads, railway stations, etc.). This is an essential element in increasing the efficiency and safety of transport networks and operations that are performed at the same.

The concept of intelligent transportation systems (ITS) is a system of measures and technologies applied to transport systems that integrate IT and telecommunication technology. The goals of establishing of these systems are reflected in the increase of traffic safety, efficient traffic flow with less downtime and a lower level of environmental pollution.

### INTELLIGENT TRANSPORTATION SYSTEMS

ITS is managerial and information and communication upgrade of classic traffic and transportation system by ensuring a much higher bandwidth, safety, protection and environmental acceptability compared to the solution without ITS applications. This does not mean that before the ITS was no intelligence in traffic, but through the real time data gathering and processing as well as network distribution of information achieves considerably congestion reduce, queuing, traffic accidents, unproductive transportation, environmental pollution, etc. "Intelligent" means the ability of adaptive action in the condition and situation changing where it is necessary to gather sufficient data and process them in real time. The concept of intelligent information system (IIS) is close to the IT staff as well as a variety of advanced techniques that are common to IIS and ITS. Concepts and techniques of artificial intelligence (AI i.e. Artificial Intelligence) - pattern recognition, machine learning, intelligent calculation and so on, are used in the design, development and implementation of various ITS applications. The European city resident lost approximately one year of life in additional waiting because of traffic congestion and lack of updated information about traffic development. ITS solutions include a redesigned transport infrastructure with a new traffic solutions, organizing and managing flows, intelligent guidance on routes with lower loads, information about available parking lot spaces, remote monitoring of cargo and vehicles, controlled - telematics toll, incident management traffic etc.

We can say that ITS is: an advanced concept of solving traffic problems, a scientific discipline, a set of technologies and new technological movement. That proves the programs and projects of ITS in all developed countries, the establishment of ITS as an academic discipline and study programs at universities, as well as the successful operation of numerous of national and international associations of ITS. Compelling reasons "for" ITS following the catastrophic level of security and external costs of traffic. According to the WHO organization (World Health Organization - WHO), more than 1.2 million people each year die from traffic, and 50 million are injured. Total direct and external costs of road accidents is 3 to 4% of GDP in some countries. ITS reorientation of transport policy means adapting the principles, measures and instruments for directing the development of transport

infrastructure and technology aligned with the general social and economic objectives. Sustainable development of the transport system involves the use of ITS solutions to the integration of different transport modes and the creation of intelligent transport and logistics networks (ITLS).

### EXISTING FUNCTIONAL AREAS AND SERVICES OF ITS

International Organization for standardization by ISO (International Standard Organization) has defined the following fields of ITS:

1. Traveler information (Traveler Information)
2. Traffic Management and Operations
3. Vehicles
4. Freight Transport
5. Public Transport
6. Emergency
7. Transport Related Electronic Payment
8. Road Transport Related Personal Safety
9. Weather and Environmental Monitoring
10. Disaster Response Management and Coordination
11. National Security

In the field of traveler information services (traveler information) includes static and dynamic information on the transport network, pre-trip services and travel information, as well as support to services that perform the gathering, storage and management of information for the planning of transport operations.

Pre-trip information service (pre-trip information) enables users to get useful information from their home, workplace or other public location about available methods, time and travel costs. Travel information (on-trip information) includes real time travel information, travel time estimation based on existing conditions of parking lot space availability, traffic accidents, etc. Information is provided via terminals at bus and train stations, streets, transit point, the screens in the car or portable personal terminal.

A cross-country guides and navigation services can be related to pre-trip and travel information about the optimal route or path to the specified destination. Choosing the best route is based on information about network traffic and public transportation and includes the most effective ways of different types of transport, taking into account the transportation costs that are minimized.

Trip Planning Support provides information on traffic flow and transport demand for the purpose of transportation planning. They are the current and historical data from the traffic management and information systems, as well as data from a moving vehicle (Probe Vehicles). In the ITS field called Traffic Management and Operations, there are several services:

- traffic management,
- traffic incident situation management,
- demand management,
- management and maintenance of transport infrastructure,
- identification of offenders.

Traffic flow management service (Traffic Control) refers to the management of traffic flows as to network of city streets, as to out of town (on the highways and elsewhere).

Examples of such services are:

- adaptive control of traffic signs and traffic lights,
- variable traffic messages,
- access control on the highway,
- speed control,
- parking control, etc.

Monitoring and removal of incidents on the roads (Transport Related Incident Management) includes detection, response and clearance of incidents on the roads or in their immediate vicinity. Only a minority of the total number of incidents are related to traffic accidents in which take part vehicles and

there are injuries or fatal injuries. In addition to a posteriori action, detection and cleanup, there is performed prediction and prevention of accidents. It is especially important to prevent secondary accidents (Post Incident Management). The focus is on traffic accidents and accidents although the system includes a response to the other causes of small incidents (puncture, missing of vehicle, etc.), as well as large accidents and disasters (earthquake, landslide, wildfires, and the like).

Demand management is a set of services which affects to the level of demand at different times of the day as well as to way inflection.

Demand management services include:

- tariff management of public transport,
- access control to certain urban areas,
- parking rates-payment of contribution to congestion (Congestion Pricing),
- induction of special tape for special vehicles with multiple passengers (High Occupancy Lane Management), etc.

Maintenance management of transport infrastructure is a set of services based on the application of ITS technologies in the maintenance of roads and associated communication and IT infrastructure.

Violations of traffic regulations monitoring (Policing / Enforcement) includes automatic detection of the vehicle type, license plates, speeding with effective back-office procedures.

The ITS area called the vehicle (Vehicles), there are several services that improve the operational safety of the vehicle:

- Vision enhancement,
- assistance to driver and automated vehicle actions,
- preventing collisions,
- safety warnings, etc.

In the Freight Transport area there are merged functions, as services related to administration of commercial vehicles, mutual coordination of transporters and other participants involved in freight transport.

Examples of services are:

- management information on the transport of goods,
- management of dangerous goods,
- Automatic verification of documents and the vehicle's weight, etc.

In the area of public transport is defined more services that allow regular and effective actions of public transport by providing updated information to users.

Examples of these services are:

- advanced public transport system,
- rolling stock management,
- advanced dispatching system,
- shared transport.

In the area of emergency services there are integrated functional processes that enable fast and effective intervention ambulance, fire, police and other emergency services. The area of emergency services increasingly integrates with the incident management team and become part of an integrated traffic management system.

Service examples are:

- automatic accident test
- automatic call in case of accidents
- coordinated management of emergency vehicles, etc.

In the field of electronic payments related to transportation there are services:

- electronic payment of public transport
- electronic toll collection,
- electronic collection of parking
- remote payments, etc.

## CONCLUSION

The objectives of the national transport policy and strategy development of transport communications and IT infrastructure at the beginning of the 21st century are closely interacting with the development of ITS. There should be a transportation policy, focused on the corridor, complete ITS and logistics orientations. Experience of the PE "Roads of Serbia" in the application of ITS reflected primarily in the automation of toll collection, automatic traffic counters, especially with regard to the Travel Meteorological Information System PMIS - developed in the road maintenance pilot - project in Macvanski and Kolubara District.

To prove the above assertion is enough insight into the current programs and directions of development of European transport infrastructure. The emphasis is on the reorientation of the road to other environmental and energy better ways of passenger and goods transport service with a complete end-to-end.

Since the ITS is a key determinant of transport development, transport and logistics in the first half of the 21 century, we can expect the inclusion of a significant part of the IT community in these projects. In ITS development there are applied object-oriented methods and tools, which is in line with the development of information technology.

## REFERENCES

- [1] [www.who.int/en/](http://www.who.int/en/)
- [2] [www.putevi-srbije.rs](http://www.putevi-srbije.rs)
- [3] [www.via-vita.org.rs/](http://www.via-vita.org.rs/)
- [4] [www.frame-online.net](http://www.frame-online.net)

## CONTRIBUTION TO THE DEVELOPMENT OF PLANTS FOR BRIQUETTE BIOMASS

**Jasna Tolmač, Dragiša Tolmač**

University of Novi Sad, Technical faculty "Mihajlo Pupin", Zrenjanin, Serbia

e-mail: [jasnatolmac@yahoo.com](mailto:jasnatolmac@yahoo.com)

**Abstract:** This paper describes the design solution of technological milling - grinding, transport and production of briquettes from straw. The project is designed and implemented for "Victoria Group" in Zrenjanin. The paper contains a description of technological process scheme of technological process, specification machine technological equipment and energy needs.

**Key words:** straw, transportation, milling, agglomeration

### INTRODUCTION

The units of the former factory for the production of sugar, "Victoria Group" in Zrenjanin has built production facility - briquettes biomass. Biomass that is specifically used in this case is the rest of the wheat plant "straw". Figure 1 shows the technological scheme of production of biomass briquettes from straw. Lower calorific value of straw is about 12 MJ / kg. It can be seen that there are two hammerhead, one for coarse grinding of straw, and the other for fine grinding of straw pellet mill and two machines for the production of the final product - pellet biomass (Dimitrijevic et al., 2012). Each project of the production process - the system has its own characteristics. Depending on the type of installation and plant projects in some of its parts may have some similarities. This applies to general and technical requirements, which must be an integral part of every major technological and mechanical design.

The aim of the design is:

1. The increase in production volume.
2. Reconstruction of existing production systems.
3. Construction of new technological systems.

Design is the first and basic stage capital construction, which ensures the construction of new and reconstruction of existing technology systems and manufacturing processes. The aim of the project production process - the system is to develop a production system that will meet the requirements of quantity and quality, in the most economical manner. When designing the production process - the system, the system designer needs to integrate the following elements:

- Production equipment,
- Means of transport,
- Storage equipment and
- Equipment for computer control.

Construction investment projects can be divided into three phases:

1. Making an investment program with a project.
2. Development of the project.
3. Performing the building and monitoring.

In the framework of this paper is to give some basic elements of the project such as: description of the technological process, the design of technological processes, budget, equipment specifications, support of safety and so on.

### TECHNOLOGY PROCESS

Straw bales are fed into debaler. Conveyor belt put the straw in the hammer for rough grinding. Pneumatic pipeline is performed to transport straw hammer for fine grinding. Minced straw is then transported by pipeline to the cyclone 1 and 2, where the separation is performed, ie. extract the straw

from the air. From the cyclone 1 and 2, by stopping the air - the rotating extractor, minced straw goes into the screw conveyor 1 and 2, and then the mixer continues to be fed to the briquetting machine, ie. pellet press 1 and 2. Aspiration system by using a bag filter for dust and fan 2. Pneumatic conveying line is suction type and transport is carried out using two centrifugal fan 1 and 2. Briquettes are then transported by conveyors and elevators lančastog, the refrigerator and the vibrating sieve. After that briquetrana mass is transported to the storage and boiler room combustion. Technological scheme of the process is shown in Figure 1.

Within this paper a conceptual technology solution systems - Installations for the production of briquettes from biomass. Biomass that is specifically used in this case is the rest of the wheat plant "straw". The project envisaged two hammerhead, one for coarse grinding of straw, and the other for finer grinding and two pellet mills to produce finished products, biomass pellets. The solution includes: Description of technological process scheme of technological process, calculation of pneumatic transport of ground straw, specification of mechanical and technological equipment. (Dimitrijevic, 2012; Prvulović, et al., 2012; Tolmač, 2008).

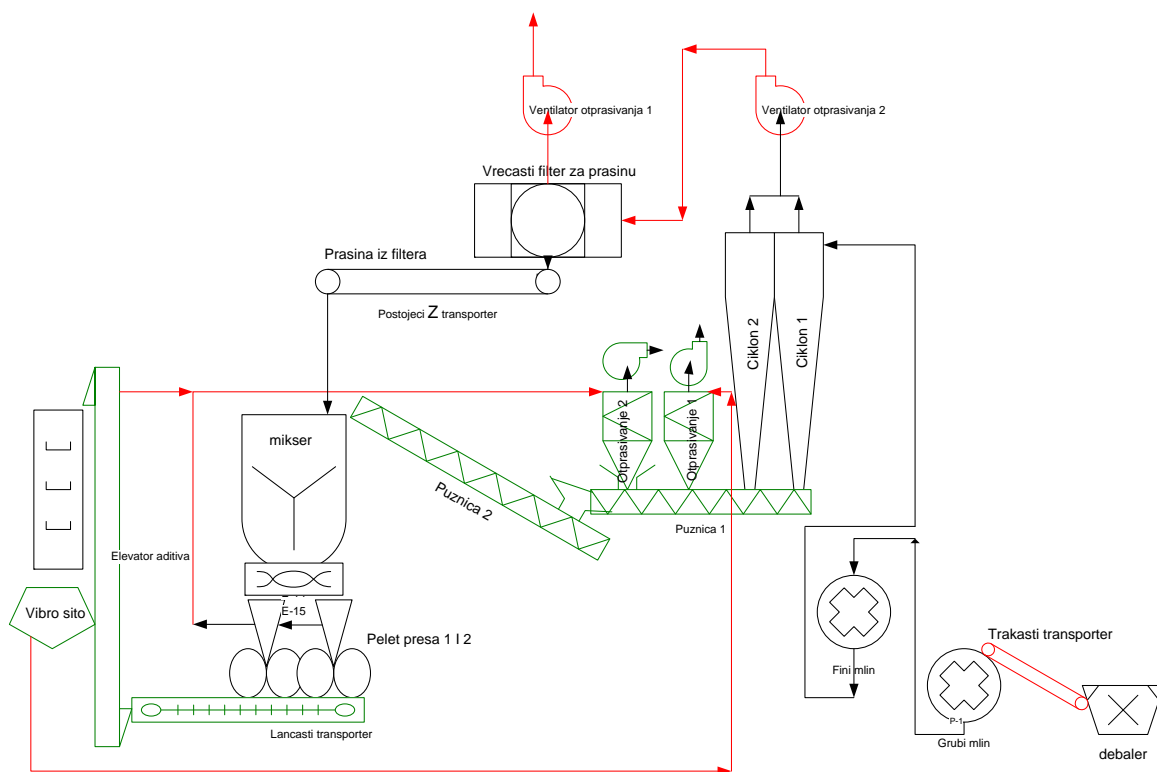


Figure 1. Technological scheme of briquettes from straw



**Figure 2.** Detail of installation cyclon (cyclone diameter  $D = 1245$  mm, rep1 and 2)

The total installed power is 423 kW. For the production unit in two shifts tj.16 hours, if the coefficient of coincidence of 0.95, the power consumption is:  $423 \times 16 \times 0.95 = 6.430$  kWh.

### **SPECIAL CONTRIBUTION OF WORKING**

Organizations working to protect the facility, should provide primarily preventive care, according litetaturi (Tolmač, 2008; Orban, 2012; Prvulović, et al., 2007):

#### **Precautionary measures to protect**

All working parts (joints, pulleys, etc.). Protected with protective sheeting. Order the removal of static electricity, machinery and equipment associated with each other and earthed. All flange - Flange with elevators, pipelines and the like. bridging the copper tape. All machinery and equipment must be enclosed and therefore it is strictly forbidden to open the lid during operation, and other elements. In the case of audit and related activities on the machine, it must be ensured that the worker will look to avoid a sudden release of machines in operation. Machinery and equipment should be maintained as per the supplier. If you need welding, etc.. this will only work when the machines and equipment out of service prior to the preparations. Staff in this facility must fully understand the basic rules of safety at work, preventative measures to prevent fire and operate fire extinguishers.

Every employee must know the function of certain machinery and equipment, and in a prominent place must be displayed prohibition of the use of faulty equipment to warn of danger when operating. Before the start of some lines or machines beep personnel must be alert. Work organization is required to carry out training of workers in health and safety matters and to



inform workers of their rights and obligations in the field of occupational safety, working conditions and hazards in the workplace, measures and means of Occupational Safety and verify training workers for independent and safe operation .

## CONCLUSION

Plant for crushing - grinding and pneumatic transport straw capacity of 4.000 kg / h, built in "Victoria Group" in Zrenjanin, enables the preparation of chopped straw briquetting. Agglomeration is performed on two machines for pelletizing. After that, the pellet mass is stored in a separate silo cell. The pellets are used for combustion in boilers to produce steam. Lower calorific value of briquettes is (16 to 18) MJ / kg.

Factory "Victoria Starch" in the process of wet processing in the most modern way of producing corn syrup and starch. Some capacity used for the storage of crop residues for the company "Victoria Group" which owns "Victoria Starch" and the straw will be used to produce energy. This kind of business is a good example to close the cycle of procurement of materials, processing of raw materials, production, and that all this is done in one facility to cut costs in particular to reduce the energy consumption will be 2-3 times cheaper. Victoria Logistic company buys raw materials for all manufacturing facilities. Annually purchase about 70.000 tons of barley straw, wheat and soybeans needed to produce cheap energy in these capacities. To produce steam in a future corn processing plant daily consumption is estimated at 300 tons of crop residues. According to current calculations, construction of the "Victoria Starch", among other things rationally designed production elements and the energy produced in this way, facilitate return on investment of 50 million. EUR in only three years.

## REFERENCES

- [1] Dimitrijevic, D., Prvulović, S. Blagojevic, Z., Tolmač, J. Tolmač, D. (2012). Ideal Solution For Grinding Plants And Pneumatic Conveying Straw, Proceedings, pp.192-195, II Int. Conf. Industrial Engineering and Environmental Protection, 2012. October 31st. Zrenjanin, Serbia.
- [2] Dimitrijevic, D. (2012). Transport production and use of biomass, Master thesis, Faculty "Mihajlo Pupin", Zrenjanin.
- [3] Prvulović, S., Tolmač, D. (2012). Transport Systems - a collection of solved problems, Technical Faculty "Mihajlo Pupin", Zrenjanin, 2012.
- [4] Prvulović, S., Tolmač, D. Radovanovic, LJ, Blagojevoć, Z. : Theory of System Design - design, investment, re-engineering, Technical Faculty "Mihajlo Pupin" Zrenjanin.2007.
- [5] Tolmač, D. (2008). Design of technological systems - manufacturing systems, Technical Faculty "Mihajlo Pupin", Zrenjanin.
- [6] Tolmač, D., Prvulović, S. (2001). Projects of technological systems in the food industry, "SM"-Engineering, Zrenjanin.
- [7] Tolmač, D. (2009). Design, Technical Faculty "Mihajlo Pupin", Zrenjanin.
- [8] Tolmač, D. (2006). Transport Systems, Technical Faculty "Mihajlo Pupin", Zrenjanin.
- [9] Tolmač, D. (2009). Machines and apparatus, Technical Faculty "Mihajlo Pupin", Zrenjanin.

## IMPROVISED ACTIVE SOLAR COLLECTOR

Jonaš Darjan<sup>1</sup>, Đurđev Mića<sup>2</sup>

<sup>1</sup>University of Novi Sad, Technical Faculty "Mihajlo Pupin", Zrenjanin, Serbia

<sup>2</sup>University of Novi Sad, Faculty of Technical Science, Novi Sad, Serbia

e-mail: [darjanjonas@gmail.com](mailto:darjanjonas@gmail.com)

**Abstract:** This paper has aim to show how a solar panel for active room heating can be built with little effort and investment. It is known for a long time that solar collectors are very expensive in Serbia, whether imported from abroad or due to some private producers in Serbia, which later formed the European market price. The paper shows how it is possible to make an improvised solar collector with minimal investment. Presented is method of work, all working procedures, cost of production, as well as statistics, or output power of this collector

**Key words:** solar collector, independent work, solar energy

### INTRODUCTION

Today, the use of information technology can inform and inspire people in many ways. Technology keeps improving, and with her progress costs are growing as well. But for most of the products made industry there is possibility to develop them in "our own" workshop. This paper presents an example of very useful tool that has been created with relatively low cost and thereby may provide similar benefits as well as being made in the industry. It is about a solar collector for supplemental home heating with directly air heating. It is important to note that this is solar panel that is almost entirely made of aluminium cans.

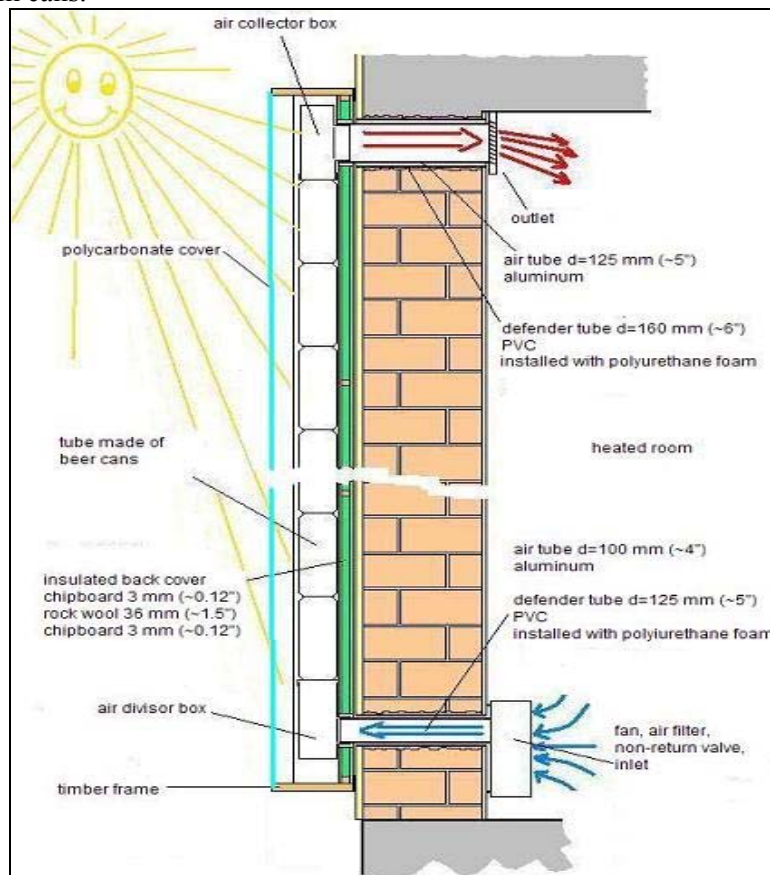


Figure 1. Solar active wall

Solar collector housing is made of wood (polywood 15mm), while its front side is made of plexiglass/polycarbonate (glass is also usable), 3 mm thickness. On the back side of housing is placed

glass wool (styrodur 20 mm is also usable) as isolation. The solar absorber is made of beer cans and soda cans that are painted with matt-black color resistant to high temperatures. The upper part (cover) of can is specifically formed to provide greater efficiency during heat exchange between can and air. When the weather is sunny, regardless of the outside temperature, canned air is heated very quickly. The fan is used to return heated air back into the room that is heated.

### METHOD AND MATERIAL OF SOLAR COLLECTOR

Firstly, the empty cans are collected with the purpose to make this solar panel. Cans are generally made of aluminium, but there are some that are made of iron. To determine which material are they made of, magnet is appropriate tool for it. Each can floor is drilled using a drill toll as shown in Figure 2.



**Figure 2.** Can drilling process

It is necessary to pay attention to the precise drilling to form a small fins on the top of each can. Their task is to stimulate turbulent flow of air inside the tube of solar panel, so that air collects as much heat from heated wall of the can as it passes through the tube. Therefore, it is important to carefully cut top cans in the form of stars and bend them with pliers.

Before gluing cans, it is necessary to clean grease and dirt from the can surface. Any synthetic degreasing agent will serve very well to this purpose. Degreasing would be desirable to do in ventilated room or clean area. Since the procedure is highly flammable, there is potential danger of explosion, and therefore a special note is given. It is dangerous to work with this near open flames or burning cigarettes.

Cans can be attached using any glue or silicone resistant to high temperatures, at least up to 200 °C. There are also products for gluing that can withstand up to 280 °C or 300 °C. Can cover and bottom of other can fits perfectly into each other. Glue/silicone is placed on the edge of the can and bottom of the other can is pressed on her. In this way glue/silicone will not leave the edge. The detailed section of glued can is shown on Figure 3, and finished and taped can sequences are shown on Figure 4.



Figure 3.

Figure 4.

Figure 5.

After that, the stacking can template is prepared, as shown on Figure 5. Two ordinary flat boards connected with nails can be also used. The template will provide support during the process of drying cans in order to obtain flat tube, also known as “solar tunnel”, Additional fastening of can to template is done using jar rubbers.

Boxes of intake and exhaust part are made of wood or aluminium foil (thickness of 1 mm) and gaps on the edges are filled with adhesive tape or heat-resistant silicone. Box covers have cutouts of 55 mm made by stationary drill. Drilled parts are shown on Figure 6 and Figure 7. The first row of cans is glued to the cover of intake box. Figure 8 presents the view of assembled parts, and collector is ready for painting.



Figure 6.

Figure 7.

Figure 8.

The glue dries very slowly. It is necessary to leave it to dry for at least 24 hours.

The solar absorber fits into housing made of wood (Figure 9). The back of the box of solar collector is made of chipboard. To further consolidate the design, the inner strip partions can be created. Between these partions is placed isolation – glass wool or styrodur. All this is covered with a thin plywood board. Installed isolator is presented on Figure 10 and Figure 11. In particular, there should be more attention to the isolation around the opening for entering and leaving air.



Figure 9.

Figure 10.

Figure 11.

At the end, the solar absorber is painted black and placed in the diy solar panels casing. The casing is covered with plexiglass that we attach to the frame and thoroughly complained silicone. Polycarbonate / plexiglass is slightly convex in order to gain greater strength. You can see installed solar absorber without plexiglass in Figure 12. Complete solar collector is shown on Figure 13, and finally, installed solar system can be seen in Figure 14.



Figure 12.

Figure 13.

Figure 14.

**Important note:** Our solar system is not able to accumulate thermal energy after producing it. When it's sunny, the solar collector produces heat, but it is necessary to use it immediately for heating the air inside the house. If the sun does not shine, it is necessary to interrupt the supply of air in the solar collector, because otherwise the room will begin to cool off. This can be solved in a simple way – by installing the valve, which will reduce the heat loss to a minimum.

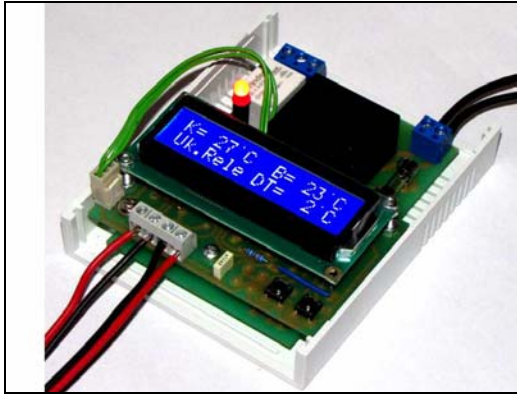


Figure 15.



Figure 16.

Differential thermostat (snap disc Figure 15.) controls the fan. This thermostat can be bought in better-equipped electronic component stores. The unit has two sensors. One placed inside the top opening for warm air, the other inside the lower opening for the supply of cold air in the solar collector. Fan characteristics are 120 mm 1300 rpm (speed propeller) and make a noise of 17 dB, which means that the noise level is minimal. Fan is shown in Figure 16.

**Costs of production:**

The following table shows a list of materials needed for the production of solar can ( tin ) heater. In the bottom of the table you can see total costs of making a complete solar panel.

**Table1.** List of materials for solar panel.

Material	Amount	Unit	RSD	EUR
Plexiglass	2.5	m <sup>2</sup>	2,500.00	24
Alu Scheet 0.55mm	0.50	m <sup>2</sup>	540.00	5.4
Wood 15mm	1.2	m <sup>2</sup>	1,200.00	12
Wood 4mm	2.5	m <sup>2</sup>	950.00	9.5
Paint for wood	2	Canikin	600.00	6
Paint, black mat	3	Spray	200.00	2
Styrodur 20mm	4	m <sup>2</sup>	600.00	6
Silicon HI-temp	2	Tube	250.00	2.5
Silicon, red	2	Tube	250.00	2.5
Electric fan	1	Piece	350.00	3.5
Alu. Profiles	6.5	Meter	850.00	8.5
Dif. Thermostat	1	Piece	2500.00	24
			RSD	EUR
<b>In Total</b>			10,790.00	105,9

**Table 2.** Technical characteristics of the panel:

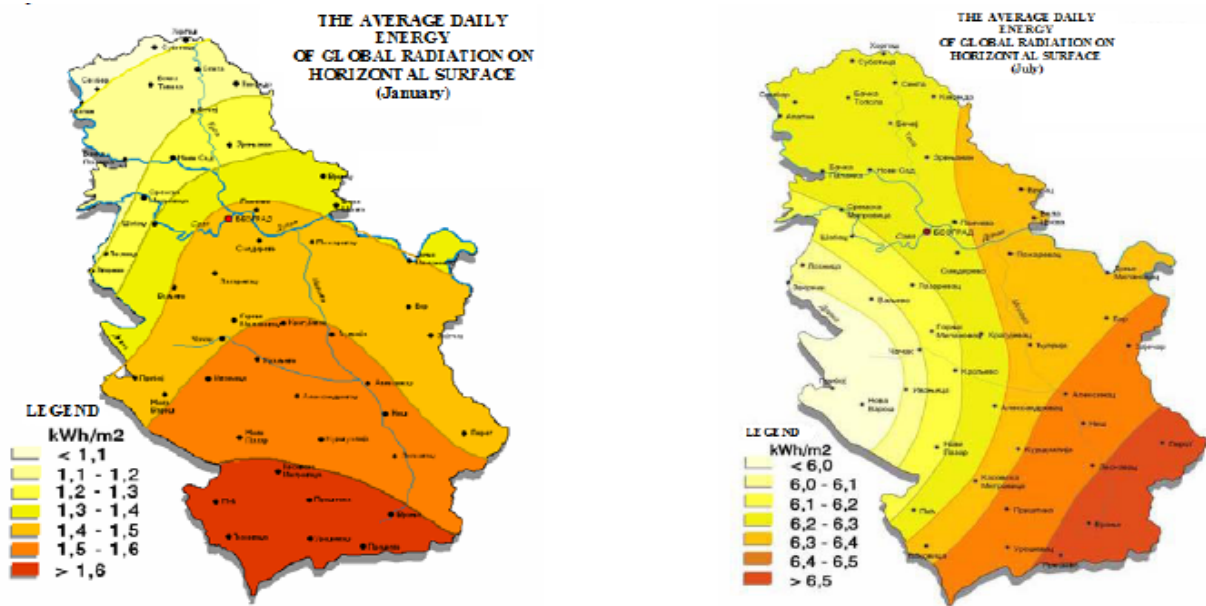
<b>Width</b>	1010mm
<b>Height</b>	2200mm
<b>Depth</b>	160mm
<b>The total area</b>	2.4 m <sup>2</sup>
<b>Ef. Collector Area</b>	2.3 m <sup>2</sup>
<b>Diameter inlet</b>	100mm
<b>Diameter of drain hole</b>	125mm
<b>Number of cans</b>	225pieces
<b>Orientation</b>	Vertical / Horizontal
<b>Weight</b>	66kg

**Note:** Given that the plexiglass is more UV stable, it is more expensive like other materials. The solar panel can be made from lexan (which is considerably cheaper), but keep in mind that the panel will

then have a slightly lower efficiency. It is important to choose a lexan or plexiglass that is UV stabilized so you will have not to make replacement after a few years due to the deformation caused by constant exposure to sunlight.

## RESULTS AND DISCUSSION

If on/off temperatures are set carefully, diy solar panels are able to produce an average 1 -2 kW of energy for home heating. This generally depends on how much sun do we have during the day. Dress rehearsal of solar collectors carried out in the backyard before installing the system on the house. It was a sunny winter day, no clouds. As a fan is used a small cooler extracted from a faulty power supply of PC. After 10 minutes in the sun from the solar collector is out hot air temperatures of 30°C! The test results have encouraged us to install solar heater on the house as soon as possible.



**Figure 17.** The average daily energy of global radiation on horizontal surface in January and July in Serbia

The highest annual income of energy is obtained if the surface is oriented towards the south and has a slope of 30 °C, the orientation and slope are optimal for the period March-April and August-September. The energy potential of solar radiation is about 30% higher in Serbia than in Central Europe and the intensity of solar radiation is among the largest in Europe.

After completing installation of collector, the outside temperature was -3 ° C, and from the solar collector is coming out 3 m<sup>3</sup>/min (3 cubic meters per minute) of heated air. In the home version we used more powerful fan than for the test. Heated air temperature went up to +34 °C. Temperature was measured by digital thermometer. To calculate the heating power of the collector, we took the air flow, and average air temperature exiting from the device. Calculated power that the solar panel produced, was approximately 1950 W (watts) which is almost 2.6 HP.

## REFERENCES:

[1]. Miroslav Lambić, Energetics, 2007., Zrenjanin.

Useful web addresses:

[2]. <http://www.freeonplate.com/solar-panels/>

[3]. [http://static.kupindoslike.com/Diferencijalni-termostat\\_slika\\_XL\\_8130653.jpg](http://static.kupindoslike.com/Diferencijalni-termostat_slika_XL_8130653.jpg)

[4]. [http://www.endpnoise.com/e/images/zm-f3\\_contents.jpg](http://www.endpnoise.com/e/images/zm-f3_contents.jpg)

## APPLICATION OF POLYMER PACKAGING IN INDUSTRIAL DESIGN

Viktorija Verebeš, Eleonora Desnica

University of Novi Sad, Technical Faculty "Mihajlo Pupin", Zrenjanin, Serbia

e-mail: [viki.verebes90@gmail.com](mailto:viki.verebes90@gmail.com)

**Abstract:** The design and packaging construction of a product play a vital role in determining the expiration date of a product. The right choice of packaging materials and packaging technology maintain product quality and keep the product in good condition during storage and distribution. Packaging is no longer used only for transport of goods to distant markets, but is an important factor when selling products to customers.

**Key words:** plastics, polymers, packaging, materials, design.

### INTRODUCTION - THE DESIGN AND MATERIALS

The meaning of the word design is a drawing, blueprint, pattern or a project. The design is used as a replacement for: technical aesthetics, industrial aesthetics, industrial design and modeling. Technical aesthetics refers to aesthetics of technical products. The industrial design refers to the activities of creating the shape of a product. Modeling a product indicates the formation of the final product as a model. When it comes to design the next terms should be distinguished: Industrial design (design of cars, household appliances, furniture, phones, clothes, toys), graphical design (design of books, posters and packaging), web design, fashion design, jewelry design, design of ceramics and glass and eco-design. [1]

Materials are substances of which something is composed or made. Under substance it is assumed for example: pure metal, chemical compound or a group of substances or alloys. Materials relevant to technology should meet the following criteria: to have technically usable qualities in at least one state of matter and to be technologically and industrially reproducible. Materials that are traditionally used for packaging include: glass, metals, paper, cardboard, wood and plastics. Several different forms of plastics is used in rigid and elastic form. Today's packaging is often made up of several materials to take advantage of functional and aesthetical benefits of each material. [2]

Scientific and technical discoveries improved the technologies and materials for packaging. Small-sized cubes, aluminum tubes and packaging made of foil products are designed to provide protection, comfort, affordability and longer expiration dates. [3]

Manufacturers with many branded products have come to acknowledge the need for engineers to be part of the development team for wrapping and packaging of a product and the designers the marketing team. The demand for convenience and valuable products has dictated many aspects of the development of materials and marketing. The need for efficiency, reusability and the environmental concerns also gained in importance as a reflection of changes in the values of consumer society. [3]

The packaging is today fully integrated in overall development strategy of a company's brand. With their long history of brand management, packaging designers are of vital importance for the partnership business and they are required not only to be able to create a visual design of a product but also to understand marketing, finances, sociology, psychology, economy and international trade. [3]

Packaging is increasingly used not only for transportation of goods to distant markets, but also represents an important factor in selling the products to demanding customers. In recent years the importance of packaging is increasingly emphasized as one of the main factors not only for transport of goods but also in selling them on demanding foreign markets. The packaging plays a very important role in attracting the attention of customers, providing information about the product and often influences the decision for buying the product. Today packaging represents an integral part of a product and it need to be adjusted to the needs and demands of the consumers. The design and construction of a package play a vital role in determining the lifespan of a product. The right choice of packaging materials and technologies will maintain product quality and good condition during storage and distribution. [3]



## POLYMER MATERIALS

There are several advantages in the use of polymer materials for food packaging. Polymers can be produced as sheets, figures and structures providing significant flexibility in the design. Polymeric materials are chemically resistant, inexpensive, and lightweight with a wide range of physical and optical properties. Some of the polymeric materials have the ability of heat welding, they are easy to print, can be integrated in the production processes where the package is formed, filled and closed in the same production line. The main drawback of the polymeric materials is their variable permeability to light, gasses and steam. [3]

Polymeric materials can be:

- Thermosetting plastic, and
- Thermoplastic plastic.



**Figure 1.** Plastic packaging

Thermosetting plastics are polymers which become rigid or permanently shaped when heated and cannot be re-shaped. Due to their strength and endurance their primary use is leaning towards the auto industry and in construction as adhesives and coatings. [3]

The use of polymers in food packaging has continued to grow thanks to the low cost of the material and functional advantages such as welding, optical properties, unlimited size and shape. Multiple types of plastic is used for packaging food including: polyethylene, polyester, polyvinyl chloride, polistrilen, and polyamide. The main packaging materials are poliofileni and polyesters. [3]

## POLYETHYLENE AND POLYPROPYLENE

Polypropylene and polyethylene are commonly used for food packaging. Polypropylene and polyethylene have good combination of properties including elasticity, rigidness, brightness, stability, resistance to moisture and very suitable for recycling and repeated use. Polyethylene can be of low or high density. High density Polyethylene is used for making bottles for milk, juice and water, cereal boxes, margarine boxes, shopping bags and garbage bags. Low density Polyethylene is elastic, strong, sturdy, easy to close and moisture resistant. Low density Polyethylene is relatively transparent, mainly used in cases when thermal closure is necessary. Bags for bread, frozen food, flexible lids and bottles are examples of low density Polyethylene. High density Polyethylene containers are mainly recycled from plastic packages. [3]

Polypropylene has good resistance to chemicals and efficiently stops water vapor. Polypropylene has a high melting point which makes it suitable for applications where thermal resistance is required.

Polypropylene is used to make yoghurt pots and margarine. [3]



Figure 2. Packaging of polyethylene



Figure 3. Packaging made of polypropylene

#### **POLYVINYLIDENE CHLORIDE (PVDC)**

PVDC has the capability of thermal welding and serves as an excellent barrier to water vapor, gases, and fat and oil products. It is used for inelastic packaging as a monolayer film and coating. PVDC is used for packaging of canned meat, cheese, snacks, tea and coffee. PVDC is also used for storage at low temperatures. [3]

#### **POLYSTYRENE**

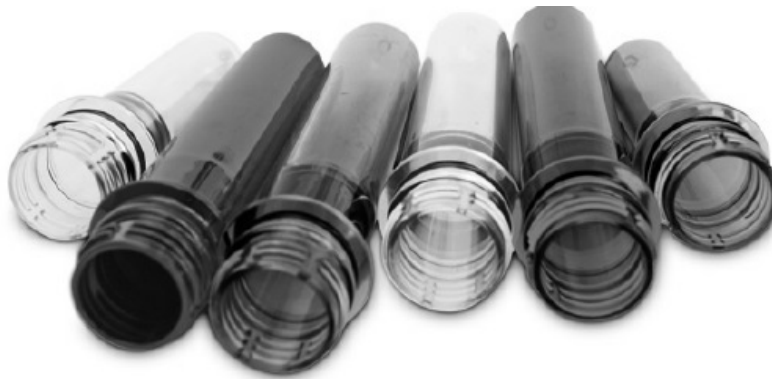
Polystyrene is a polymer of styrene. It is a hard, clean and highly flammable material with a relatively low melting point, used for protective packaging of cookware, disposable cutlery, lids, cups, plates, bottles and trays for food. [3]

#### **POLYAMIDE (NYLON)**

Polyamide is mainly used in the textile industry. Nylon offers good chemical resistance, strength and low gas permeability. [3]

#### **POLYESTER**

Polyethylene terephthalate (PET), polycarbonate (PC), polyethylene and oil (PEN) are polyesters. PET is the most common polyester for food packaging. PET has good resistance to gas and moisture, has good heat resistance, mineral oils, solvents and acids. PET is used for creating packages for many food products, beverages and mineral water. The main reasons to use PET packaging are its transparency like as glass, corresponding barrier for keeping the carbonation of drinks, light weight and resistance to breaking. Recycled PET bottles are used for insulation and nonfood packaging. [3]



**Figure 4. PET**

### **POLYCARBONATE (PC)**

PC is clean, heat resistant and durable. Polycarbonate is used as a substitute for glass in case of large water bottles for multiple use and small bottles that can be sterilized. [3]

### **POLYETHYLENE NAPHTHALATE (PEN)**

Polyethylene Naphthalate is a polyester with high heat transfer coefficient. PEN shows better results at high temperatures than PET, making it possible to have multiple hot filling, cleaning and use. PEN is 3 to 4 times more expensive than PET. It also provides protection against flavor and odor transfer. [3]

### **POLYVINYL CHLORIDE (PVC)**

Polyvinyl chloride is a tough, heavy, flexible and amorphous material. PVC is highly resistant to chemicals, fats and oil and has stable electrical properties. PVC packaging is used in medical and nutritional purposes. Its use in the food industry includes bottles and films for packaging. PVC is difficult to recycle and its burning is a major environmental problem due to the high chlorine content. [3]



**Figure 5. PVC**

### **CELLOPHANE**

Cellophane is obtained by chemical processing of cellulose but it has no fibrous structure like the paper. Cellophane is used for packaging consumer products. Unpainted cellophane is transparent like glass, with a smooth and shiny surface. It serves as an excellent barrier to air, odor and dust. It is used for packaging products that need to be protected from dust, packaging of food products, tobacco products and textiles.

High resistance to water and water vapor also makes it a very widely used packaging material, especially in packaging confectionery dried products containing fats and oil. [3]

## CONCLUSION

The new trend of developing plastic materials is in the production of biodegradable materials. Plastic packaging provides excellent protection for products and it is also cheap and durable. Production of packaging from renewable resources has a significant contribution in terms of lower energy consumption during production and disposal. Bioplastic products are characterized by biodegradability and functionality of products that will be much wider used in the future.

## REFERENCES

- [1] Desnica, E., Nikolić, M., Industrial Design, Technical Faculty "Mihajlo Pupin", Zrenjanin, 2012.
- [2] Stojadinović, S., Ljevar, A., Tasić, I., Knowledge of materials, Technical Faculty „Mihajlo Pupin“, Zrenjanin, 2007.
- [3] Cvetković, D., Marinković, D., The packaging design, Beograd, 2010.

## CITIZENS' AWARENESS ON GEOTHERMAL ENERGY IN THE TOWN OF ZRENJANIN

Mila Zakin, Ljiljana Radovanović

University of Novi Sad, Technical Faculty "Mihajlo Pupin", Zrenjanin, Serbia

E-mail: [milazakin@yahoo.com](mailto:milazakin@yahoo.com)

**Abstract:** This paper analyzes the importance of geothermal energy to the human community. There are analyzed the benefits that renewable energy contributes to various spheres of human life. This article aims to show that geothermal energy is present everywhere and that there are technological features that it very effectively used. The research was carried out by interviewing residents, whose purpose was to examine the awareness of the people in the town of Zrenjanin on the application of geothermal energy.

**Keywords:** geothermal energy, heat pumps, potential savings, Serbia.

### INTRODUCTION

Nowadays most people understanding energy is reflected only as a form of coal, oil and gas, and is produced by thermal power plants and hydro power plants. Given that in humans is not fully developed awareness of the different types of energy, geothermal energy, which is the most frequent and most accessible is hidden and not used. Under geothermal energy means energy that can be downloaded from water, soil and rock whose temperature exceeds 10 ° C. One of the most common ways to use this energy as heat pumps. Since January 2009. The use of heat pumps is definitely included into renewable energy sources [1]. A heat pump uses one of the basic laws of thermodynamics that energy can neither be created nor destroyed but only change its form and its place of existence, it transfers 80 % of the energy from the environment with 20 % of electricity. Climatic conditions in Serbia are ideal for the application of heat pumps, because of the winter working in the heating mode, a fly in the cooling mode. Heating with heat pumps is cheaper 9 to 16-fold compared with equivalent fossil fuel heating, wood or electricity in conventional boilers. [1] The use of geothermal energy for heating and cooling is a primary route in the world and the European Union. In Europe, they set very high goals regarding the use of renewable energy and reduced emissions. In early 2007a. The Council of Europe has announced its goal of achieving 20 % share of renewable energy in the structure of energy production 2020th year. Set high goals for the reduction of primary energy consumption by 20% by 2020th year while reducing carbon dioxide emissions by 20% led to the fact that renewable energy sources are considered as the backbone of savings [2]. In these savings application of heat pumps will take a significant share of 22%. Council of the European Union adopted a decision to the 2020th every year, a brand new residential or commercial building needs to be energy independent. Geothermal energy is the most appropriate for achieving those goals, and therefore the only one of all renewable energy in several European countries entered into a legal obligation to use to heat the new building. Given that potential of geothermal energy in the country in a large percentage is not used, it is necessary that its activities related to energy is channeled into the direction in which they are directed by the European Union and other developed countries.

### MATERIAL AND METHODS

For insight into the real state of Zrenjanin what people think of geothermal energy was carried out empirical research. The research methodology is based on the formulation of the survey on geothermal energy, which is shown in Table 1. Questions are normally designed to incorporate awareness of the respondents about the problem, respectively basic statements, information and opinions. Part of the survey are further sub-target students Technical Faculty "Mihajlo Pupin" in Zrenjanin, in order to comprehend the mind of young and educated people. The second part of the questionnaire were randomly distributed in order to look into the minds of people with different levels of educational attainment and of different ages. Information based on data from surveys are basically quantification

type, with elements of qualitative type in a few questions. Data were statistically analyzed after which the results are displayed on a graph for better visibility. The objectives of this study were:

1. Research of awareness on geothermal energy in the city of Zrenjanin.
2. Determining the opinion of the people that will apply in future geothermal energy.
3. Determining the attitude of the citizens of the benefits of using this energy.
4. Analysis of the awareness of the citizens in the operation of geothermal power through heat pumps.
5. Detection of bottlenecks and find solutions that would affect the use of geothermal energy in the city of Zrenjanin to a higher level.

**Table 1.** Survey "Geothermal Energy " [3]

GEOHERMAL ENERGY		
r.br.	Questions	Answers
1 th	Do you know what is geothermal energy?	1 2 3 4 5
2 th	Do you know what it can be used geothermal energy ?	1 2 3 4 5
3 th	Did you know that Serbia has a very good potential for geothermal energy?	1 2 3 4 5
4 th	Do you think that geothermal energy has a positive impact on the environment ?	1 2 3 4 5
5 th	Do you think that the use of geothermal energy provides financial savings for energy consumers ?	1 2 3 4 5
6 th	Do you think the country is sufficiently motivate their residents to use geothermal energy?	1 2 3 4 5
7 th	If the 6 question is given a negative answer , write your suggestions on how to increase the motivation of using geothermal energy	1 2 3 4 5
8 th	Are you informed about what is in the municipality of Zrenjanin done regarding the use of geothermal energy?	1 2 3 4 5
9 th	Were you instructed to geothermal energy for the benefit of people across the heat pump ?	1 2 3 4 5
10 th	Do you know what the heat pump ?	1 2 3 4 5
11 th	If you were able , would you decide to use geothermal energy for their own needs (heating domestic hot water , heating and cooling ) ?	1 2 3 4 5
12 th	If the 11th given the negative response , write why.	1 2 3 4 5
13 th	Have you heard that the geothermal energy as " clean energy "?	1 2 3 4 5
14 th	* If it is a 13 was answered positively , write why you think they call it .	1 2 3 4 5
15 th	Do you think that in the future, more use of geothermal energy ?	1 2 3 4 5

## RESULTS AND DISCUSSION

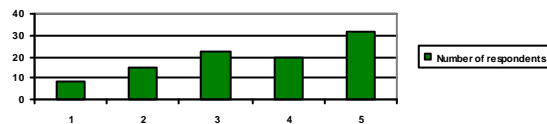
We will now graphically presents the research results, which are based on surveys of geothermal energy. The following Table 2 provides insight into the social characteristics respondents and respondents who underwent a survey of geothermal energy.

**Table 2.** Social characteristics of the respondents of the "Waste Management"

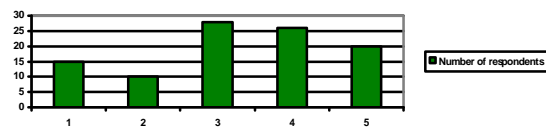
Social characteristics of respondents (rounded)					Total
What is your gender?	M	Ž			
	55	42			
How old are you?	15-30	30-45	>45		
	35	34	28		
The level of education?	OŠ	SSS	VŠ	VSS	
	22	33	17	25	97

Based on the perceived informing of citizens, depicted in Fig.1. It can be concluded that the majority of respondents referred to the term "geothermal energy". It should be noted that a significant proportion of respondents pleaded that is very indefinite that might be addressed, while a very small percentage of respondents pleaded not addressed. The positive side, respondents if not entirely, but what is referred to geothermal energy. It can take some time in which to apply this energy intensive, and that the knowledge of this term was higher. Media attention, a variety of education and the most important practices should be directed to familiarize people with the operation of this power.

When respondents perceived familiarity of what can be used geothermal energy is shown in Fig.2., It can be concluded that familiarity is lower than familiarity with the concept of energy as shown in the previous Fig. 1.

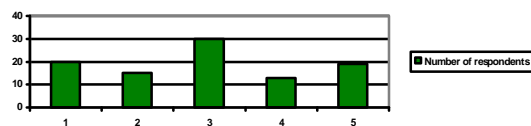


**Figure 1.** Knowledge of the term "Geothermal Energy"



**Figure 6.** Familiarity of citizens on the application of geothermal energy

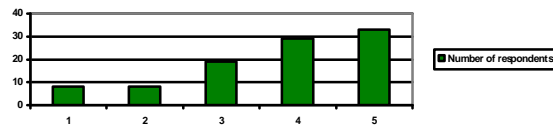
When we look at the knowledge of the respondents that Serbia has good potential for use of geothermal energy as shown in Fig 3, it can be seen that the lack of information increases relative to the familiarity of the concept and application of energy. Most of the respondents who are not familiar with and are not sure if they are well informed. People often think that their environment is not the most appropriate and do not have with good potential for a lot of things, and therefore need to emphasize more on the advantages and potential of our country.



**Figure 7.** Citizens are informed about the potential for the application of Serbia geothermal energy

Based on the results of the respondents are shown in Fig.4., It can be seen that in the majority agreed with the statement that geothermal energy has a positive impact on the environment. It is interesting that the respondents were in a much greater number declared that they were not sufficiently informed about the concept, implementation and geothermal energy's potential, and yet believe that it has a positive impact on the environment. From this we can see that even people not familiar with what

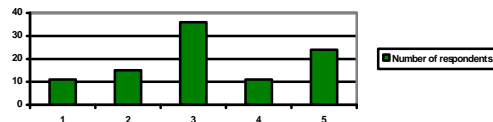
constitutes a term are considered to realization it can contribute to a better life in a city. People's willingness to accept that something important in their own settings to use and expand their understanding revolve around.



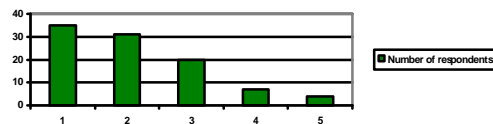
**Figure 8.** Awareness of the impact of geothermal energy on the environment

Based on information analyzed subjects depicted in Fig.5. it can be concluded that the highest percentage of respondents were not sure that the use of geothermal energy provides financial savings for consumers. To potential users opted to use the energy necessary to put emphasis on short-term repayment and financial savings to be realized. Citizens' opinions in a very high percentage that the state does not motivate people to use geothermal energy, as shown in Fig.6.

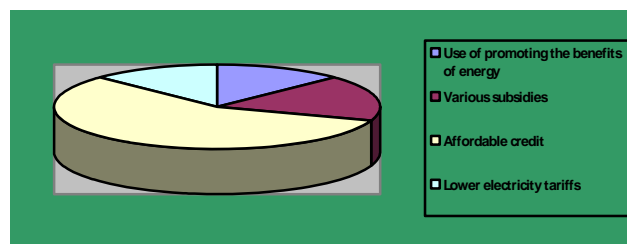
Through the efforts of the state to motivate citizens to a greater extent, would be drastically increased awareness and the awareness of the people, and the very use of this power, it is therefore necessary that the state take larger and educate residents about the benefits of this energy. Suggestions on how the state can motivate people to use geothermal energy are shown in Fig.7.



**Figure 9.** Informing citizens about the financial savings to the consumer when used geothermal energy



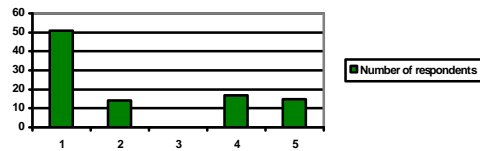
**Figure 10.** Citizen's opinion about the motivation of the state for the use of geothermal energy



**Figure 11.** Suggestions on how the state can motivate people to use geothermal energy

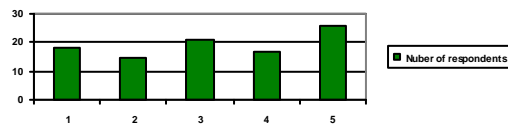
Based on the results of the survey are that the knowledge of the respondents about what is in the municipality of Zrenjanin done as far as geothermal energy is very low ( Figure 8). Respondents were most pleaded not informed until a few pleaded addressed . It is necessary to promote a much greater extent when the municipality apply this energy , would have created a positive attitude about it and the various biases and uncertainties could be eliminated, if the residents see how it goes in the middle of them . In the municipality of Zrenjanin is also the first school " Jovan Luci " it's installed geothermal heating , funds granted through the IPA CBC programs [4]. It was built and a residential building ( buildings ), which will provide users over heating heat pumps , with a lower price of heating with district heating . Such examples will be provided to Zrenjanin citizens clear picture of the application of geothermal energy, will raise awareness about the importance and benefits of this energy source , which will result in the use of geothermal energy on a large scale .



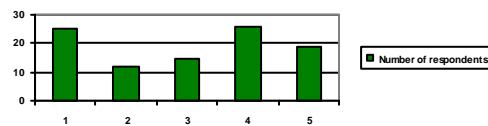


**Figure 12.** Awareness of what is in the municipality of Zrenjanin done in terms of geothermal energy

On the basis of familiarity of respondents to geothermal energy for the benefit of people across the heat pump, it can be concluded that familiarity partially broken, respondents have a slightly higher percentage of whom were sent as shown in Fig. 9. When informing the public about the benefits of energy necessary to put emphasis on how it can all be used and what are the devices that make up this energy usable for various purposes. Familiarity of the respondents what are the heat pump, is more strongly positive. The respondents have stated that if they are not fully addressed, at least partially addressed as shown in Fig. 10. In applying this energy on a large scale, will be expanded and insight into what people are heat pumps, how to use and what is the advantage of using them.

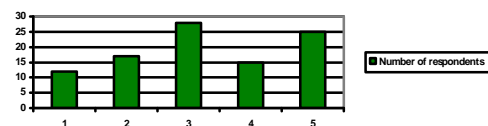


**Figure 13.** Familiarity citizens to use geothermal energy through heat pumps



**Figure 14.** Familiarity citizens what the heat pump

On the basis of results of determination for the use of geothermal energy , the highest percentage of respondents said they would perhaps decided , the rest in the highest percentage of respondents said that they would have opted for the use of geothermal energy as shown in Fig.11.



**Figure 15.** The commitment of the respondents for the use of geothermal energy

Respondents who had a question: "If you allow the possibility, would you use geothermal energy? " Pleading not choose to use this power, have expressed their reasons for which are shown in Fig. 12. The first reason is that a high percentage given is that it is considered that this form of energy does not function as a standard, it is necessary to show people how it works in the peaches and the best example of this practice is that it be implemented in their city . Another reason is that the respondents believe that technology in our country does not work good enough for you, you should not generalize The technology , manufacturers and importers is still a high quality and technologies and not quality. It should be noted that in our country there are systems that work flawlessly for over 30 years [5].

The third reason represents a lack of information, education of the population through school and out of school systems is very important to increase awareness.

Based on the perceived familiarity of respondents, that geothermal energy is called "clean energy", which is shown in Fig.13. It can be seen that the majority of respondents said that they might be addressed, not sure of the date the claim, while the remaining majority pleaded addressed. All types off the energy needed in a larger scale closer to the people, that is advantages of using this energy and point to practices in our country and other developed countries. Based on the questions on the awareness that geothermal energy is called " clean energy " as shown in Fig. 13, of those who were sent were required to explain the reasons for this energy is called pure. All respondents have stated that the reason for the naming of geothermal energy is clean energy because it does not pollute as shown in Fig. 14. It is very positive that the reason given is correct and that the proportion of respondents aware that the use of clean energies reduce pollution that are harmful to the environment. Addition, based on a forensic patients, the results are very positive , because the majority of respondents stated that they believe that geothermal energy is applied to a greater extent in the future Fig. 15. A significant number of respondents were not sure, which is quite expected because the lack of familiarity of respondents about the problem usually results in an undefined prediction. Very small sample of only 5 of them are declared negative, which is still positive as the number of respondents who declared himself negatively in relation to the declaration of the previous statements and opinion between decreased.

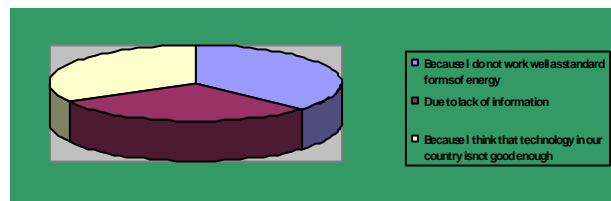


Figure 16. Reasons why you would not choose to use geothermal energy

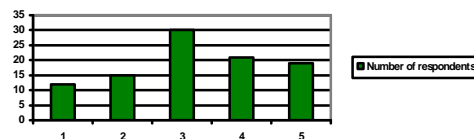


Figure 17. Familiarity that geothermal energy is called " clean energy "



Figure 18. The reasons why geothermal energy is called "clean energy"

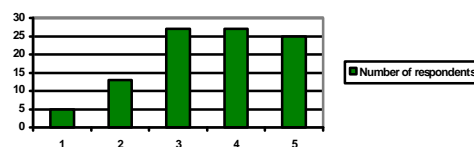


Figure 19. The application of geothermal energy on a larger scale in the future

## CONCLUSION

Based on the research it can be concluded that people's awareness of geothermal energy is not fully developed. It is necessary to approach to the citizens the significance of this energy and its use to facilitate their various subsidies, competitions and benefits. The use of this energy in the city of Zrenjanin and therefore in the Republic of Serbia would directly impact on the conservation of natural resources affecting the quality of life. Since the estimated quantity of geothermal energy that could be used much more than the overall quantity of energy sources based on oil, coal, natural gas and geothermal energy should certainly be given more importance. Especially if you take into consideration it is a cheap, renewable energy source that is also the environmentally friendly. The

increasing unpredictability of the price of energy generated from fossil fuels, environmental pollution, as well as compliance with the Legislation of the European Union calls on the urgency of establishing a coherent state policy in this field and the integration of measures to stimulate the use of geothermal energy.

#### REFERENCES

- [1] Jankovic, V., "How to use the hidden potential of Serbia" 2009, Belgrade
- [2] European Council (2007): European Council Act 7224/1/07, Rev. 1.
- [3] Zakin, M., „Sustainable development in the municipality of Zrenjanin, student paper, University of Novi Sad, Technical Faculty " Mihajlo Pupin " Zrenjanin, 2013.
- [4] <http://www.ilovezrenjanin.com>
- [5] <http://www.bes.rs>

## PRODUCTION OF A PIG IRON IN A BLAST FURNACE, STEEL IN THE CONVERTER AND THEIR FURTHER PROCESSING BASED ON THE Fe-Fe<sub>3</sub>C DIAGRAM

**Branka Simić, Slobodan Stojadinović**

University of Novi Sad, Technical Faculty "Mihajlo Pupin", Zrenjanin, Serbia

e-mail: [simicina@gmail.com](mailto:simicina@gmail.com)

**Abstract:** Basics of raw and gray iron production are presented, with a view to the blast furnace processes and the accompanying chemical reactions. Classification and manner of production of cast iron is given, emphasizing technological details related to gray iron casting. Production of steel in the converter is explained, following all interphases. All these processes are generally overviewed through the phases of Fe<sub>3</sub>C process.

**Key words:** pig iron, gray iron, steel, Fe<sub>3</sub>C diagram

### INTRODUCTION

The greatest application of all technical alloys are alloys of iron (Fe), which are classified as iron, steel and ferro-alloys. Widespread use of these alloys (90% of total world production of metallic materials), is based mainly on the following factors: iron ore is found in large quantities in the Earth's crust, iron alloy are produced in a relatively inexpensive procedures, good combination a of different properties is relatively easily achieved. The basic elements of all kinds of steel and iron as iron (main component) and carbon (alloying component).

Today, iron is generally obtained with oxide, and less carbonate ore: magnetite (Fe<sub>3</sub>O<sub>4</sub>), hematite (Fe<sub>2</sub>O<sub>3</sub>), limonite (2Fe<sub>2</sub>O<sub>3</sub>·3H<sub>2</sub>O) and siderite (FeCO<sub>3</sub>). Red iron ore contains mineral hematite. Other minerals include magnetite, which is black and magnetic. Iron is rarely found in elemental form (except from some volcanoes and meteorites). Oxide of iron ore is obtained by reduction of ore coke i.e. carbon monoxide in the furnace. The reduction can be done directly using the carbon from the used coke as a fuel, or indirectly by carbon monoxide resulting from burning of coke. Iron that is processes into steel and gray foundry iron usually is obtained in the furnace because the process in electro-reduction furnaces is more expensive. Iron cast straight from the oven is called pig iron. The main difference between the white pig iron (which is processed into steel) and gray (foundry) pig iron, both obtained in a molten state from a furnace, is in the chemical composition and the way of curing that takes different cooling rates. Gray iron is obtained by slow cooling, often in sand molds, which provides extrication of carbon in the form of graphite. Iron for processing into steel is obtained by rapid cooling, which is achieved by casting in metal molds, with the carbon extracted in the form of cementite.

### PRODUCTION OF RAW IRON IN BLAST FURNACE

Basic materials for the operation of blast furnace are iron ore, fuel and melting material. In nature there are oxide, sulphide and carbonaceous ore. The most commonly used are oxide ore and hematite (Fe<sub>2</sub>O<sub>3</sub>) and magnetite (Fe<sub>3</sub>O<sub>4</sub>). Before insertion into a furnace, sulphide and carbonaceous ore are translated into oxide via roasting. The iron content in the ore ranges from 23% to 70% and represents the basic measure of ore grading for the processing of metal (richer in minerals, the more suitable for processing). Iron ore includes other metal oxides: silicon dioxide (SiO<sub>2</sub>), alumina (Al<sub>2</sub>O<sub>3</sub>), lime (CaO), magnesium oxide (MgO)... They contain compounds of sulfur, phosphorus and arsenic, which are sometimes considered harmful impurities. Most of the ore is not suitable for direct processing, so it is necessary to prepare them, which mainly includes the removal of overburden, ore drying and grinding or consolidation (briquetting).

Melting materials are solid additions which, during melting process, transform hardly soluble ingredients of overburden into easily soluble ones. Melting materials may be alkali, usually limestone

(CaCO<sub>3</sub>) or acidic, such as SiO<sub>2</sub>, which is used in the form of quartz, gravel or sand. Limestone in a blast furnace breaks into lime (CaO) and carbon dioxide (CO<sub>2</sub>). Lime binds excess silica in calcium sulfide (CaS), which reduces the sulfur content of the iron, which, as a harmful impurity can be found in ore and coke. If mine overburden contains mainly silicon dioxide, ore has acidic character and if it contains mostly lime and magnesium oxide, then is alkali. Ores in which the content of silica, lime and magnesia is balanced are called self-melting ores, because no melting material adding is required.

Role of fuel is to provide the necessary amount of energy for operation of the blast furnace process and the necessary amount of carbon that allows the reduction of ore - deprivation of oxygen (de-oxidation):

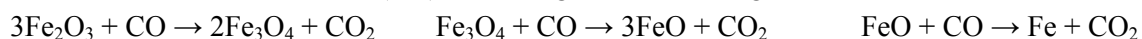
1. Combustion of fuel achieves temperature required for melting;
2. Incomplete combustion fuel provides carbon monoxide for indirect reduction of ores;
3. Part of its carbon is used for the direct reduction of ore;
4. Part of its carbon goes into pig iron.

First fuel for the blast furnace was charcoal, and now the most commonly used is furnace coke (stone coal containing at least 90% of carbon). Coke is more suitable because it has a high calorific value, appropriate hardness and, because of its porosity, burns completely.

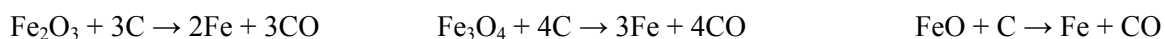
The blast furnace is constructed of fireclay in a steel sheath. Coke, ore and melting material (limestone) are put in furnace through the top opening (hatch) in certain quantities and in a specific order. Raw materials are brought by a special transport unit on the upper platform furnace and extradited to the charging station. Total furnace height ranges from 20 to more than 30 meters.

During operation furnace is being refilled so it works continuously. At the bottom of the furnace (oven) are open drain molten iron and slag (slag). Blowers are located at the bottom of the furnace, through which overheated air is blown (600-900°C), required for the combustion of coke. Excess gases generated in the process of obtaining iron leave the furnace through the top opening. In the temperature range of 250-480°C raw material is heated by the heat of excess emissions. At a temperature of about 480°C begins ore reduction, which ends in the middle of the oven. At temperatures of 1150- 1250°C begins formation of the first drops of liquid iron which are flowing to the bottom of the oven. At 1650°C melting of oxides within overburden is over, which, with the ash and melting material form a liquid slag. Slag floats on the surface of liquid iron and protects it from oxidation. Liquid pig iron is released from the lowest part of the furnace every few hours into the prepared pans, which drains iron into steel mill for further processing. Liquid slag is also being released and transported to the slag granulation plant or for other processing.

Since at the higher temperatures the affinity of carbon and oxygen is greater than between iron and oxygen, chemical processes in the blast furnace include indirect and direct reduction of ores, as well as carburizing liquid iron. Indirect reduction is gradually taking place in the temperature range 480-1200°C with carbon monoxide (CO), according to the following reactions:



Direct reduction is carried out in the temperature range of 1000-1200°C, according to the following reactions:



Carburizing is done using carbon in the high temperature region, where the affinity of iron to carbon is high enough, according to the following reactions:

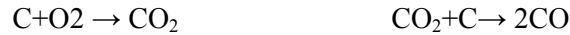


Fuel in the blast furnace does not burn completely and furnace gases contain enough carbon monoxide and hydrogen, so it can be used for heating of air heater and boilers. So they're caught in the maw of the blast furnace under the battery charger and drain through pipes for further exploit. Gas furnace is treated before usage to remove fine dust which can clog combustion chamber and thus disrupt the blast furnace.

Products of blast furnace are melted iron, liquid slag and blast furnace gas. They are not final products, but are used as raw material for further processing. Molten iron, depending on the chemical composition and solidification rate is used as a raw material for processing into steel or cast iron. Chemical composition of iron for the processing of steel is 2.5- 4% C, 0.9- 1.4% Si, 0.5- 1.5% Mn, up to 0.25% P and up to 0.12% S. Chemical composition of the cast iron is 3.6-3.8% C, 1.25- 3.75% Si,

0.7- 1.1% Mn, 0.3-0.7% P and 0.04 to 0.06% S. After solidification, slag can be processed and used in construction. Blast furnace gas at the exit of the furnace has temperature of 250- 400°C and it can be used for heating of small furnaces in foundries. products of blast furnaces are also ferro- alloys such as ferrosilicon and ferromanganese.

Carbon monoxide is produced in reaction of oxygen from the air and carbon from the coke in two phases:



Iron produced in the blast furnace is very rigid due to the high content of carbon, phosphorus and sulfur. Only very small quantity of it is cast into molds that are not subjected to large mechanical strain, e.g. stovetops. Most of the pig iron is melted in electric ovens: addition of melting materials increases level of purity while suitable batch keeps the composition in certain boundaries. This is a secondary cast iron or cast iron.

Cast irons are alloys of iron with more than 2.0% carbon. Cast irons have a low plasticity and relatively low resistance to impact. They are used because of the good properties of casting, broad range of strength and hardness, good machinability by cutting (in most cases), and low cost. If improvement of some properties is required, e.g. resistance to wear and corrosion, cast iron is additionally alloyed. Advantages of cast iron compared to steels have better casting properties, lower melting temperature (up to 300- 400°C) and lower price. The structure of cast iron depends primarily on the chemical composition and cooling rate of cast. In practice, cast iron contains 2.0-4.0% C, 1-3% Si, Mn, P and S. The content of Si is very important for the properties of these alloys, and is therefore often classified as triple alloy Fe-C-Si. Cast iron is obtained by melting gray cast iron (with the addition of scrap metal) in cupola furnaces, smelting and electric furnaces. According to the composition and structure, cast iron can be:

1. Gray cast iron (cast iron) - carbon in the form of lamellar graphite.
2. White cast iron (white - hard cast) - carbon bound in the form of cementite.
3. Nodular cast iron (ductile iron) - the carbon in the form of spherical graphite (nodules).
4. Tempered iron (malleable cast iron) - in the form of temper carbon-graphite.
5. Vermicular cast iron, where graphite is separated in vermicular (worm) form.
6. Alloy cast iron (iron alloy).

**Table 2.** Chemical composition of gray, nodular and tempered iron

	C	Si	Mn	S	P
Gray cast iron	2,5-4,0	1,0-3,0	0,25-1,1	0,025-0,25	0,05-1
Tempered iron	2,0-2,6	1,1-1,6	0,20-1,0	0,04-0,10	0,18 max
Nodular cast iron	3,0-4,0	1,8-2,8	0,10-1,0	0,03 max	0,18 max

In the above casting, influence of the chemical composition can be traced to the influence on the process of carbon sequestration. The elements are divided into those that help extract carbon (C, Si, Ni, Cu, Al), and those that help extract the cementite (Mn, S, Cr and W). The increased content of C and Si, as the most influential elements, acts the same as the increase in castings cross-section to obtain the same microstructure. Castings with large cross- sections cool more slowly, which helps extract graphite. Sulfur is considered harmful because it reduces the fluidity of iron and promotes the creation of pores. At a higher sulfur content, sulphide eutectic at metal grain boundaries is created, which adversely affects the mechanical properties. If there is a manganese, MnS inclusions are created that are less harmful. Phosphorus increases casting possibilities, so it is especially important for the production of thin-walled castings. However, at higher phosphorus content, phosphide eutectic at the metal grain boundaries is formed, which adversely affects the properties of iron. If phosphorus occurs in the form of Fe<sub>3</sub>P and if its properly distributed in the metal matrix, it increases the resistance to wear. Structure basis of cast iron depends on the cooling rate, and can be: perlite cementite (hard cast) - high speed cooling, perlite graphite (pearlitic gray cast iron) - average cooling rate, and ferrite graphite (gray cast iron ferrite) - low speed cooling.

Gray cast iron is produced from gray iron by slow cooling that allows abstraction of carbon during solidification in the form of graphite lamellae. Quality and mechanical properties of gray cast iron depend on the structure of basis, quantity, size and distribution of graphite lamellae. Gray cast iron

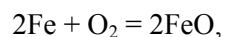
metal base can be ferrite, pearlite or mixed-ferrite - pearlite. The more pearlite in cast, greater the tensile strength and hardness. Lamella graphite adversely affects the properties of gray cast iron, reducing the resistance to impact load. Therefore, the carbon content is limited to 4%. Gray cast iron is resistant to wear and corrosion, good cutting processes, conducts heat well and dampens vibration. Gray iron castings are cheaper than other castings. By adding 0.3-0.8% of ferrosilicon in molten iron just before pouring, we get a modified cast iron, in which lamella graphite are reduced and transformed into more favorable form. This modified cast iron has many advantages such as increased tensile strength, hardness and toughness.

## BASICS OF STEEL PRODUCTION

Steels are alloys of iron with carbon and other elements. Steels are the most used group of mechanical materials. Couple of thousands of different kinds of steel are known and they are used in almost all areas of mechanical engineering. Steel is produced from white pig iron by oxidation of excess impurities: C, Si, Mn, P, S, which are extracted in the form of slag and gases.

Production of steel in the converter is a main stage in the production of liquid steel and consists of several stages: batching steel pieces into converter, infusion of iron, adding of non-metallic additives, oxygen processing- blowing, steel- casting, deoxidation and alloying. Production of steel is basically refinement of iron from blast furnace and addition of ferro- materials. Iron for steel-processing contains up to 4 % C , 1.4% Si, 1.5% Mn , 0.25 % P and 0.12 % S. Therefore, in the production of steel, contents of these elements are reduced to the required value. Molten iron is processed into steel in the Siemens- Martens furnace (flame process), in the electric furnace (melting) and in Bessemer or a Thomas converter. The main difference between the Siemens - Martens process and the electric furnace melting (conversion process) is reflected in the way of getting the heat required for the production of steel. While in the first case, an external heat source (combustion of gas in the Siemens - Martens process or electric arc as the most common variant of the electric furnace) is needed, in conversion process required amount of heat is provided through chemical reactions used for purification of steel, primarily oxidation with pressured oxygen.

Selection of processes for the production of steel depends on several factors, the most important are the quality and price of the obtained steel and chemical composition of iron, i.e. its purity. Iron with a higher content of silica is used in the converter processes (Bessemer procedure), or with a higher content of phosphorus (Thomas procedure), which in the purification process of iron gives an extra amount of heat. Pure oxygen reacts with iron:

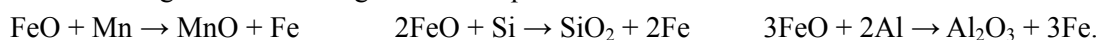


FeO oxide reacts with carbon and impurities:



This reaction is followed by release of heat, which is sufficient for steel to remain in a liquid state, and oxidation products (CO, SiO<sub>2</sub>, MnO, P<sub>2</sub>O<sub>5</sub>). In this way, the content of C, Si, Mn and P is brought to a necessary level, while for the reduction of sulfur content calcium from melting materials is used. That way a chemical compound CaS is built, which also goes into the slag.

Before casting, manganese, silicon and aluminum are added to steel as deoxidizers. Deoxidation is carried out according to the following chemical equations:



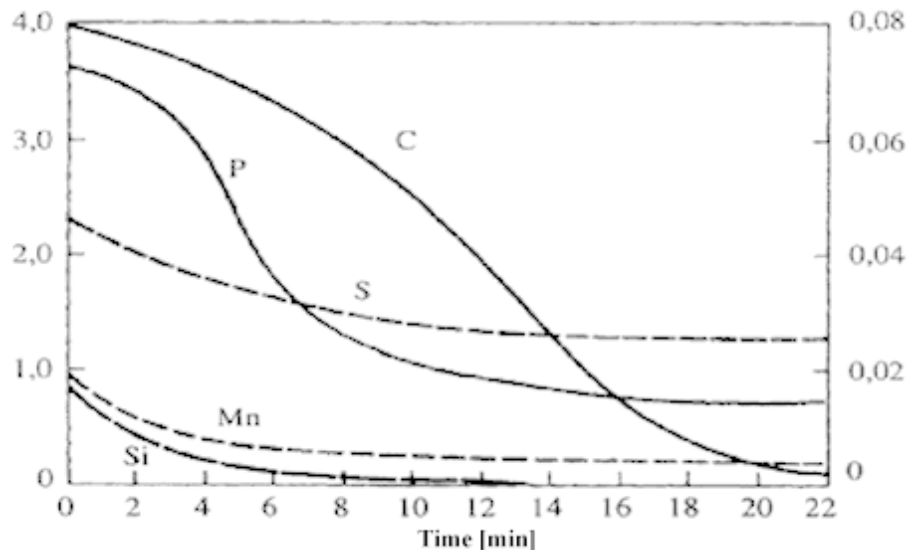


Figure 20. Reduction of chemical elements during the oxidation process [4]

The resulting chemical compounds are removed in the form of slag. The next stage in the production of steel is molding during of the transition from liquid to solid state. Liquid steel is cast in metal molds, where solidifies into so-called ingots. They are then heated to about 1200°C and wallow into blooms, billets and slabs. Subsequent cold or hot rolling produces thicker or thinner plates and wires. Traditional way of casting ingots is increasingly being replaced by continuous casting. The molten steel is poured into the auxiliary vessel, where the dirt is removed from the surface. After that steel passes through a copper crystallizer in which solidification begins and, in the end, through the cooling chamber, where the solidification ends. Drip molding is extracted, bend and straightened so it will enter cutting machine with the speed equal to the speed of discharge into the auxiliary container. The procedure has a number of advantages over ingot casting, because you get a more homogenous and small- grained steel structure due to higher cooling rates. On the other hand, the process is more economical. In the process of production and casting, steel easily dissolved gases (O<sub>2</sub>, N<sub>2</sub>, H<sub>2</sub>, CO<sub>2</sub> and CO) that cause porosity and inhomogeneity of the structure, which primarily reflects badly on the mechanical properties. Considering the amount of residual gases during solidification, steels are divided into un-calmed, semi-calmed and calmed. Un-calmed steels contain up to 0.3% C and about 0.02% Si, and they are incompletely deoxidized with Mn and Al (deoxidizers). They are characterized by the presence of gas pores along the outside of the ingot, which provides a softer surface layer, and thus easier cold deformation processing. They are used for making plates and rods. The pores present in un-calmed steels impact the reduction of toughness, fatigue strength and the ability to weld. Calmed steels contain more than 0.3% C and from 0.15 to 0.6% Si. They have homogeneous and void-free structure and are suitable for use at low temperatures. Semi- calmed steels contain 0,3-0,9% of C and about 0.15% Si. In addition to Mn and Al, Si is also used as deoxidizer. They are used for economical production of profiles and thick plates.

### Fe-Fe<sub>3</sub>C DIAGRAM

Following phases exist on Fe-Fe<sub>3</sub>C diagram: liquid solution of iron and carbon, ferrite ( $\alpha$ )- an interstitial solid solution of carbon in Fe <sub>$\alpha$</sub> -body centered, austenite - an interstitial solid solution of carbon in Fe <sub>$\gamma$</sub> -face centered and cementite (Fe<sub>3</sub>C)



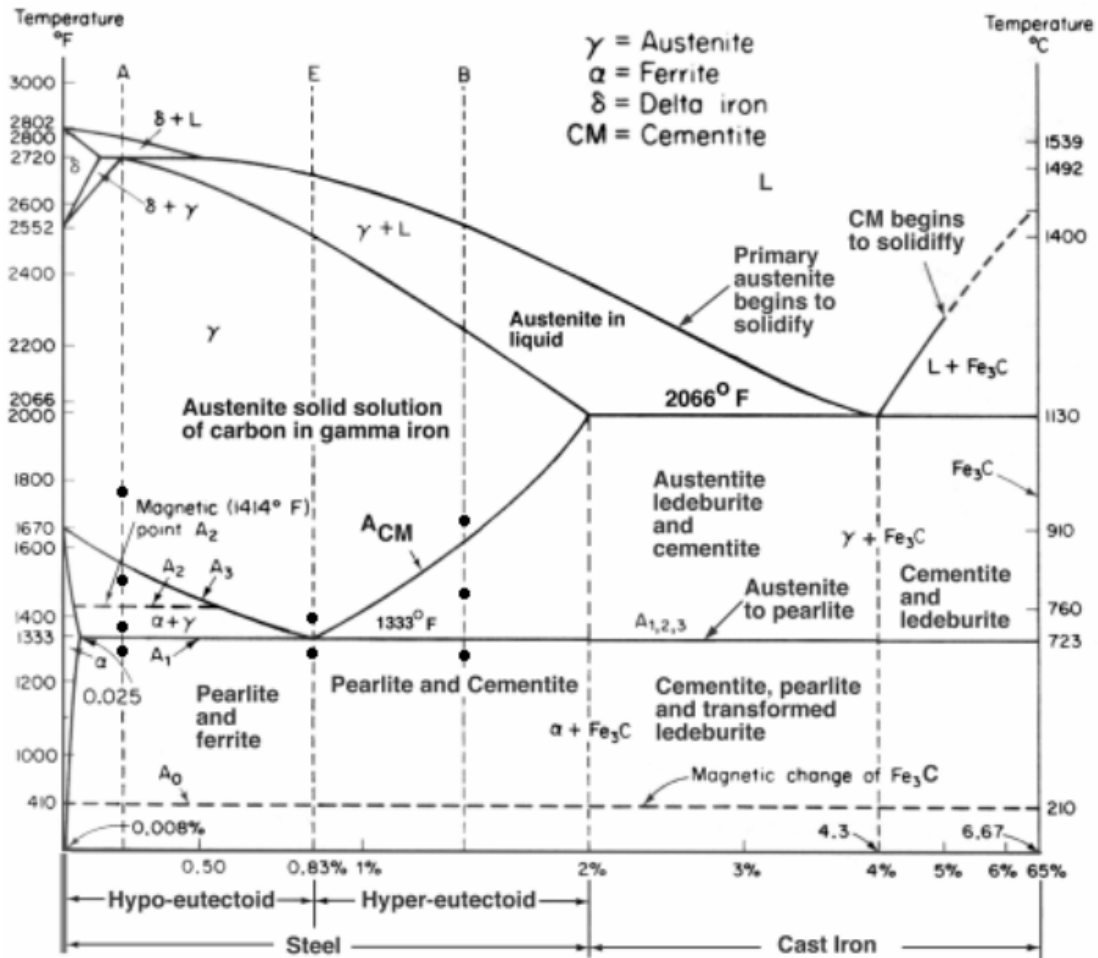


Figure 21. Phase diagram Fe-Fe<sub>3</sub>C [4]

Figure 2 shows the equilibrium diagram for combinations of carbon in a solid solution of iron. The diagram shows iron and carbons combined to form Fe-Fe<sub>3</sub>C at the 6.67% C end of the diagram. The left side of the diagram is pure iron combined with carbon, resulting in steel alloys. Three significant regions can be made relative to the steel portion of the diagram. They are the eutectoid, the hypoeutectoid, and the hypereutectoid. The right side of the pure iron line is carbon in combination with various forms of iron called alpha iron (ferrite), gamma iron (austenite), and delta iron. Allotropic changes take place when there is a change in crystal lattice structure. From 2802°F-2552°F (1529°C-1392°C) the delta iron has a body-centered cubic lattice structure. At 2552°F (1392°C), the lattice changes from a body-centered cubic to a face-centered cubic lattice type. At 1400°F (760°C), the curve shows a plateau but this does not signify an allotropic change. It is called the Curie temperature, where the metal changes its magnetic properties. Two very important phase changes take place at 0.83% C and at 4.3% C. At 0.83% C, the transformation is eutectoid, called pearlite, while at 4.3% C and 2066°F (1130°C), the transformation is eutectic, called ledeburite.

Microstructure depends on composition (carbon content) and heat treatment. When alloy of eutectoid composition is cooled slowly it forms pearlite, a lamellar or layered structure of two phases: α-ferrite and cementite (Fe<sub>3</sub>C). The layers of alternating phases in pearlite are formed for the same reason as layered structure of eutectic structures: redistribution C atoms between ferrite and cementite (6.7 wt%) by atomic diffusion. Mechanically, pearlite has properties intermediate to soft, ductile ferrite and hard, brittle cementite. Hypoeutectoid alloys contain proeutectoid ferrite (formed above the eutectoid temperature) plus the eutectoid pearlite that contain eutectoid ferrite and cementite, while hypereutectoid alloys contain proeutectoid cementite (formed also above the eutectoid temperature) plus pearlite that contain eutectoid ferrite and cementite.

## CONCLUSION

The greatest application of all technical alloys are alloys of iron, which are classified as iron, steel and ferro-alloys. Iron is extracted from its ores: magnetite, hematite, limonite and siderite. Pig iron is usually obtained in crude furnaces, due to lower prices of the process. It is, because of the higher content of impurities and carbon, very fragile and unsuitable for processing or use. It can be used only for the casting of roughest massive objects that are not mechanically or thermally loaded. To obtain higher quality iron or steel, pig iron is processed, which includes the reduction of all the ingredients and adjustment of the desired carbon content, which essentially determines the quality of the steel. The main difference between the white and gray pig iron, which are produced in the same way in a furnace, is the chemical composition and method of curing that takes different cooling rates. Steels are the most used group of mechanical materials. Production of steel is basically process of refining iron obtained from the blast furnace and adding alloys. Molten iron is processed into steel in the Siemens- Martens furnace, the electric furnace or Bessemer or a Thomas converter. Advanced stage in the production of steel is casting during transition from liquid to solid state. Liquid steel is cast in metal molds where it solidifies into ingots, which are then heated to approximately 1200°C and wallow into semi- products.

For studying of steel and cast iron two diagrams of state are used: metastable (Fe-Fe<sub>3</sub>C) and stable (Fe-Cgr), because the carbon in iron ore can be in bound form (cementite Fe<sub>3</sub>C) or free, such as graphite. The diagrams describe processes and the changes that are taking place at different temperatures of melting or cooling.

## REFERENCES

- [1] Stojadinović S., Ljevar A., Tasić I. Poznavanje materijala, III prošireno izdanje TF „Mihajlo Pupin“, Zrenjanin, 2007.
- [2] Stojadinović S., Bešić C., Desnica E. Osnovi proizvodnih tehnologija, II prošireno izdanje TF „Mihajlo Pupin“, Zrenjanin, 2008.
- [3] Tehnička enciklopedija, glavni urednik Hrvoje Požar, Grafički zavod Hrvatske, 1987.
- [4] H. Pollack, Materials Science and Metallurgy, 4th ed, Prentice-Hall, 1988.

## PNEUMATICS PRODUCTION AND RECYCLING

Dušan Kojčić, Eleonora Desnica

University of Novi Sad, Technical Faculty "Mihajlo Pupin", Zrenjanin, Serbia

e-mail: [dusan.kojcic90@gmail.com](mailto:dusan.kojcic90@gmail.com)

**Abstract:** The world without pneumatics would be something that cannot be imagined nowadays, which is why it's important to know how they are created and recycled when their deadline date has come. And like in any other industry people do their best to minimize their energy (money) loss and in doing so elevate the industry in a variety of ways for the better.

**Key words:** pneumatics, crushing, processing, production, pyrolysis, granulate, carbon, nitrogen, oxygen, feature.

### INTRODUCTION - RUBBER HERITAGE

The ancient heritage of the rubber-giving plant (*Hevea brasiliensis*) comes from Brasil, and today this plant is bred plantationally in almost all areas of the warm belt. The milky juice, that leaks out of the cut tree of hevea is called latex. By coagulation of this milky juice caoutchous is made, this word incites from the aborigin word "Cahuchu", which means the tree that cries.

Caoutchous (natural rubber, Indian rubber) is an elastomer (elastic carbonhydroxide polymer) which is originally derived out of latex, the milky coloid which is created by some plants. The tree crust is cut and then the sticky milk-a-like latex is harvested and refined into rubber. The refined form of caoutchous is polyzopren, which can be made synthetically. Natural rubber is extensively used in many products. It is naturally very tensile, flexible and highly waterproof. (fig. 1, fig. 2)



Figure 1. Hevea tree



Figure 2. Pneumatics

### PRODUCTION - RUBBER MANUFACTURING

- Mixing blends
- Calandering
- Tyre rate
- Inserts
- Tread layer
- Vulcanization
- Control

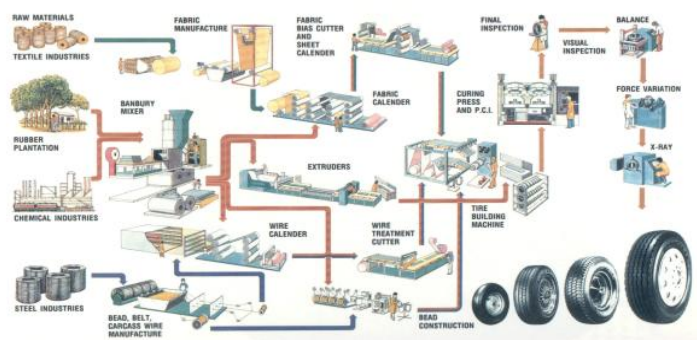


Figure 3. Stages of pneumatic production

**Blending a mixture:**

Raw materials that include pigments, chemicals and up to 30 different forms of caoutchous, on a extremely high temperature and under very high pressure are mixed in giant mixer called Banbury. All components are blent into a black, sticky mixture which needs crushing afterwards.

**Calandering:**

The cooled rubber is then flattened into plates that are transported to the next machine. Mixture is prepared there, which is then cut open the corresponding bands such as the hips, tread and other rubber parts. Other types of rubber grommets are designed for fabrics that are used for the production of construction tires. Fabrics can be very different: polyester, nylon or rayon.

**Tyre rate:**

The following is part of a ring and is called the rate. The rate should lie flat against the car wheel rim.

**Insert:**

Followed by two layers of fabric, so called. textile cord. A pair of protective strips are added, that prevent the rate of damage during mounting tires on rim.

**Tread layer:**

The garment now adds steel strips that prevent drilling and keeps tread firmly on the road. Tread is an integral part which is added at the end. Automatic rollers then firmly squeeze all the parts and the tire is ready for vulcanization and control.

**Vulcanization:**

During vulcanization of rubber gets its final shape and tread or tread pattern. Tire shaping and vulcanizing in hot molds. The mold has tread marks on the side of that specified by the manufacturer and that are required by law. Tires are 12-25 minutes vulcanized at temperatures higher than 300 degrees, depending on size.

**Control:**

If the tire has any deficiency, or if you just suspect that you might have a deficiency, the tire is discarded, even if the lack is unimportant. Some defects will be determined by the experienced eye controller, and the other will be revealed on special machines. Control, however, does not end at the surface. Some tires are taken out of production lines and sent to X-ray examination, where any hidden defects or errors in the interior are shown. In addition to this quality maintenance engineers regularly arbitrarily select a certain number of tires and then study every detail of construction that affects the durability, driving characteristics and safety.

**PNEUMATIC RECYCLING**

Pneumatic recycling methods are used in a large number of countries. It is estimated that country members of the EU produce approximately 250.000.000 wasted pneumatics, and in eastern Europe, North America, South America, Asia and the Middle east pneumatic waste is approximately 1.000.000.000. Over the years new amounts of wasted pneumatics are added to the bilions of already stored ones, or buried in depots, along with the uncharted millions found in illegal places, warehouses and fields all over the world. Wasted pneumatics are a specific type of garbage created by all vehicles. Lapsed pneumatics are usually stored on big piles in the physical and social environment. The environment is disposed to a long-term effect on it's look and potential risk of uncontrolled fire. Wasted pneumatics can be easily picked up, processed, and recycled. Pneumatics can be an important alternative material in certain rubber products, aswell as in creating energy. The material recieved by recycling pneumatics is regularly used as a valuable resource and it's use contributes to sustainable development.

## METHODS OF RECYCLING AND PROCESSING PNEUMATICS

The most used methods of pneumatic processing are: crushing and pyrolysis. The first step in recycling pneumatics is crushing, after which comes separating materials by type (rubber, steel and textile). According to the used technology and temperature of the crushing process, we differentiate two basic methods of crushing:

- Cryogenic crushing
- Mechanical crushing

### PNEUMATIC RECYCLING BY CRYOGENIC CRUSHING

In the cryogenic process of crushing, a pneumatic is initially frozen with liquid nitrogen to a temperature of  $-80^{\circ}\text{C}$  to  $-100^{\circ}\text{C}$ . On this temperature rubber loses its elasticity and can with relative ease be cut. Steel and textile parts are divided even easier. The downfalls of this process are high energy demands, problems in manipulation and usually high cost. The rubber grain produced by cryogenic crushing is bigger in comparison to the grain produced by classic crushing. The final product - granulate - has a high price, and on top of everything, the basic features of rubber change. For 1 kg of pneumatics, 0.6 kg of liquid nitrogen is spent. (fig. 4)



**Figure 4.** Use of nitrogen in cryogenic crushing of pneumatics

### PNEUMATIC RECYCLING BY MECHANICAL CRUSHING

In the process of mechanical crushing on normal temperatures, pneumatics are crushed in the facility entrance so that the homogeneity of the ingress resource and quality of production are secured. There is a difference between granulate made of pneumatics from cars and those of trucks. It is important to extract old pneumatics, because after ten years they partially lose their features and granulate exploiting is impossible. Since bigger pneumatics (tractors and field vehicles) have steel threads of up to 8 mm, and considering the deadline date of knives and the whole crushing line, these threads are removed. Steel threads are removed by cutting pneumatics to length. When free of steel threads they are thrown into the crusher with toothed rollers on the axels which are spinning in the opposite directions, where they are crushed into pieces to dimensions of 4x5cm. For more effective production, this proces is repeated two to three times. (fig. 5)



**Figure 5.** Mechanical crushing of pneumatics

### **PNEUMATIC PROCESSING BY PYROLYSIS**

Pyrolysis is based on heated separation of macromolecules with the preservation of bonds between carbon and hydrogen. These processes are possible on high temperatures in a reactor without the presence of oxygen. Certain ingredients are separated by condensation and other physical-chemical processes. The quality and amount of certain products is based on the technology used and the conditions of pyrolysis. In some cases blends of pneumatics and plastic dump are processed pyrolytically.

Pyrolytic gas which is created in so doing is used as a source of heat, and in the case of a co-generating unit, as a source of electrical energy. The facility becomes independent of electrical energy and can be built, so to speak, on an arbitrary place. Other products are also valuable resources such as: ashe, pyrolysis oil, heavy oils, oils with alkan content, benzene, toluene, metal and steel shavings. Rubber dump presents a resource with high carbon content. During pyrolysis, under the influence of heat, rubber dissolves to lower hydrocarbons with simpler bonds and non-organic materials. Carbon gas leaves the reactor and excess is left without carbon content. By cooling the created gas condenses into liquid, called "bio oil", which has the following features:

- light oil which can be used as distillate oil or diesel fuel,
- medium oil with features suitable for production of lubricants, and
- heavy oil suitable for production of carbon threads (carbon laminate)

Bio oil does not contain sulphur or any other noxious compounds. It's apt for diesel engine drive or for burning in petroleum burners of all kinds. It's also a suitable resource for production of plastics, lubricants and carbon composites. Uncondensed gas is usually spent in its own technology. The carbonised excess after the metal separation is so to speak porous carbon, which almost has the same features as active coal. It's used for filling filters for water and gas, or for further processing in the chemical industry.

Size degraded pneumatics in circular rotational ovens are transferred into a gas state under the influence of high temperature with no oxygen. Gas produced in this manner is transferred into the next section of the system, where solid matter is extracted. Gas gradually cooles, pressure changes and it transfers into a liquid state, so that in the end we get the following products:

- gas,
- oil,
- carbon powder

During the drive of the facility there is practically no waste left, only excess of steel shavings from pneumatics and ashe from impurity. Other losses are only in heat. All aforesaid products are sold easily, usually as cheap fuel or fuel for agricultural and construction plants. Created gas is used for oven heating and burning in co-generating units which produce electrical energy for driving the processing plant. From an energy point of view, the processing line is enough to sustain itself as long as it has a constant inlet of dump material. The effectiveness of a classic pyrolysis plant is 9500 tons of plastic and pneumatics a year, that's 92%. While loading 90% plastic and 10% pneumatics, we get 50% distillate oil, 37% gas and 5% carbon. Losses are 2-3% ashe and 5-6% heat. This usage of

dumped pneumatics are interesting not only from an economic, but also from an ecologic aspect, because the whole technologic process is a closed cycle and is created without any possibility of harmful emission into the atmosphere and without water and earth contamination. (fig. 6)



**Figure 6.** Pyrolysis oven

### **CONCLUSION - APPLICATION OF RECYCLED PNEUMATICS**

Physical characteristics of pneumatics, such as nontoxicity, biodegradability, shape, mass and elasticity, make them candidates for a wide range of applications in all shapes - whole, cut, in granulate form or in dust form. During the last ten years, material diversity created from dump pneumatics has increased. Construction engineers use higher amounts of material of bigger dimensions, for example whole pneumatics, shreds and pieces for use on sound ramps, isolation, light fillings, bridge pillars, among everything else they've encouraged development of new ways of use in designing depots and ecologic rehabilitation. Industrial producers use materials of smaller dimensions, made by new technologies, and blends of material for products such as car parts, sealing compounds, protective layer, pigments, also different materials for new road surfaces. By processing dump pneumatics we get crushed rubber or shred, granulate, which can have a size from 0.5 up to 10mm, and dust. Granulate has the widest application, then shred and the use of is slowly rising.

### **REFERENCES:**

- [1] Desnica, E., Nikolic, M., Industrijski dizajn, Tehnicki fakultet "Mihajlo Pupin", Zrenjanin, 2012.
- [2] [http://www.goodyear.eu/si\\_hr/tire-advice/tire-information/](http://www.goodyear.eu/si_hr/tire-advice/tire-information/)
- [3] <http://sr.wikipedia.org/wiki/Kau%C4%8Duk>
- [4] <http://www.cqm.rs/2008/pdf/3/02.pdf>

## RESEARCH SATIFICATION POPULATION SUSTAINABLE CITIES ZRENJANIN

**Ivana Petkanić, Ljiljana Litričin, Mila Zakin, Živoslav Adamović**  
University of Novi Sad, Technical Faculty “Mihajlo Pupin”, Zrenjanin, Serbia

**Abstract:** Due to the many negative anthropogenic impacts, the planet Earth has reached a very high level of vulnerability. Polluted is air, water, land, and all that will be left behind the present generation to future generations. Sustainable development is a harmonious balance between the environment and the economy, to the natural resources of our planet and preserve for future generations. Sustainable development is development that meets the needs of the present so as not to jeopardize the ability of future generations to meet their own needs. The main environmental problems in the municipality of Zrenjanin the disposal of solid waste, drinking water quality, contamination of natural surface water, excessive noise and air pollution. As the main problem is the low level of awareness of the population on environmental protection and sustainable development in genera

**Key words:** sustainable development, environmental protection, Zrenjanin municipality, population

### INTRODUCTION

City of Zrenjanin is the Central City of Central Banat District, which includes five municipalities: Zrenjanin, Žitište, Nova Crnja Novi Bečej and Sečanj. End of 2007, the new territorial division of the country level and the adoption of related laws, then Zrenjanin municipality receives administrative and territorial status of the city. According to the census of the 2011th In the municipality of Zrenjanin live 122 714 inhabitants, of which 75 743 people live in the town of Zrenjanin. The population structure is mixed, in terms of ethnicity, level of education, professional qualifications, etc.

The notion of sustainable development leads most often in connection with environmental protection, social development planning, environmental, economic and political issues. The concept of sustainable development is a new paradigm, a new strategy and philosophy of social development. In line with this, sustainable development is closely linked to the environment, to conserve natural resources for future generations.

One of the big problems today is environmental pollution. Pollution are harmful changes to physical, chemical and biological properties of the environment (air, water and land), which may adversely affect the living organisms or impair their ecosystems. The environment is a complex physical, chemical and biological conditions specific to a particular organism in a given place at a given time. The environment is an ecosphere that is composed of the biosphere, the world of nature and natural resources and technosphere, the world of human invention and created material values. The environment includes natural and man-made values and the total area in which one lives and where settlements are located, goods in general use, industrial and other facilities.

---

<sup>1</sup>Internet literature, <http://www.zrenjanin.rs/>, downloaded from the website of 21.05.2013.

<sup>2</sup>Internet literature, <http://sr.wikipedia.org/>, accessed on 15.01.2013.

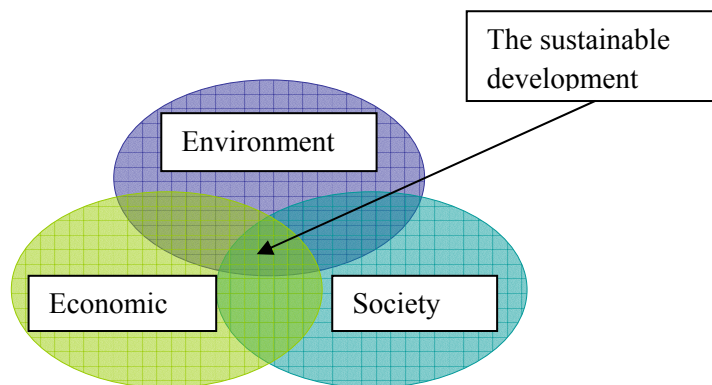
<sup>3</sup>Prof. Miroslav Lambic, Prof. Živorad Milosevic, Professor. View other Kopanja Lidija Milosevic, "Environment and Energy", Association for Energy Efficiency of Bosnia and Herzegovina, Banja Luka, 2009, p.

<sup>4</sup>Mr. Dragoljub Todić, Dr. Vukasović View, "International organizations and international cooperation in the field of environmental protection", Novi Sad, pp. 15



## THE CONCEPT OF SUSTAINABLE DEVELOPMENT

The concept of sustainable development is defined as an integrated economic, technological, social and cultural development, in line with the needs of protection and improvement of the environment that allows the present and future generations to meet their needs and improve the quality of life<sup>6</sup>. The notion of sustainability is not new. Its roots can be found in the works of classical economics in the early attempts to answer the question what is the perspective of human development<sup>7</sup>. *Figure 1* provides an overview of sustainable development.<sup>8</sup>



**Figure 1:** The sustainable development

Sustainable development should be counterbalance the destructive and disruptive effects of human activity on the planet and that the main goal is survival. This idea will enter into all human activities and lifestyles<sup>9</sup>. The concept of sustainable development is focused on the conservation of natural ecosystems and the rational use of natural resources and land associated with it to improve the quality of environment and quality of life. The concept of sustainable development foregrounds the quality of the environment, with the aim of continuous improvement of environmental quality shall apply appropriate procedures

- Consideration and evaluation of the potential adverse effects of development activities in economic and social life in the environment;
- Prediction of risk that the processes of environmental threats ( of dangerous, toxic and other substances );
- The elimination of the causes of environmental threats; Code of man's relation to the environment, which includes a healthy environment for all generations;
- Active protection of the environment through reasonable human behavior;
- The new consumer style, which takes into account the quality of the product in consumption (eco-label);
- A balanced demographic growth that is consistent with the capacity of the environment.

<sup>5</sup>The Law on Environmental Protection of the Republic of Serbia, article 13

<sup>6</sup>Sustainable Development (2008). *Excerpt from a lecture by Prof. Dr. Milan Pavlovic, Zrenjanin.*

<sup>7</sup>Kula, E. (1998) *History of Environmental Economic Thought*. London and New York: Routledge.

<sup>8</sup>Internet literature, <http://www.odrzivezajednice.org/>, accessed on 15.01.2013.

<sup>9</sup>Prof. Milan Pavlovic, *Sustainable Development*, excerpt from a lecture, Zrenjanin, 2008<sup>th</sup>

## SUSTAINABLE DEVELOPMENT AND ENVIRONMENTAL COMMUNITY ZRENJANIN

In the municipality of Zrenjanin created the strategy of sustainable development, however, is one of the major problems in the implementation of this strategy is actually very low awareness of people's lack of information on sustainable development. For the strategy of sustainable development has space for successful implementation, it is essential that people understand sustainable development and to direct their behavior accordingly. In the municipality of Zrenjanin a local environmental action plan, however, the population of the municipality Zrejanin NGOs have a very low environmental awareness. Environmental awareness can be seen as an environmental problem, because he is one of the factors of environmental pollution.

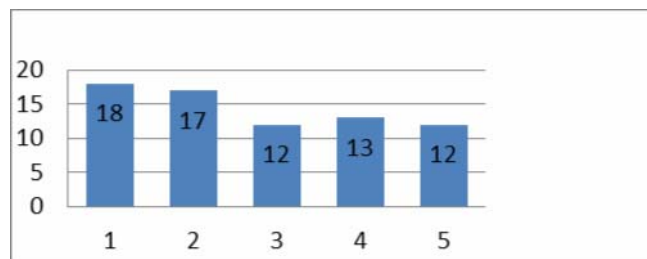
The main environmental problems of Zrenjanin are

- Disposal of solid waste- building the city dump barely meets the minimum requirements that must be met in order to enable the disposal of solid waste .
- The quality of drinking water - Drinking water quality is inadequate , because the 100 % testing of drinking water samples were chemically incorrectly , and 50 % were bacterially contaminated.
- Pollution of surface natural water - surface water analyzes show that the concentration of pollutants exceeds the maximum , even for a few dozen times. The most endangered river Bega , then Tisa and lakes in the city center . The main cause of this is the discharge of industrial waste water into a river or lake , without any pre-treatment , and sewage spills
- Air pollution - the problem is that it greatly disturbing , however , the growing stock of Zrenjanin is significantly reduced , and the area is classified in the lowest level of forestation in Europe. Also , the occurrence of odor is the result of the city's mills and rendering plants , and synthetic rubber factory in Elemir , which is the only of its kind in Serbia.
- Excessive noise - loud noise source in Zrenjanin are industrial facilities , transportation and utility noise of different origin

## INVESTIGATION OF CONSCIOUSNESS PEOPLE ON SUSTAINABLE DEVELOPMENT AND ENVIRONMENTAL PROTECTION IN THE AREA ZRENJANINA

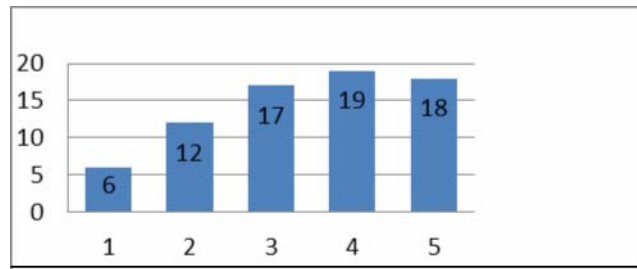
The following diagram presents the results of studies conducted over 72 randomly selected subjects. Offered to answer are regulated by the numbering so that the rounded number 1 give complete denial of the question, and by rounding the number up to 5 confirm the question. For example: 1 - no, 2 - so, 3 - maybe 4 - very, 5 - yes (descriptions of numbers are adjustable according to the set question)

### Sustainable development

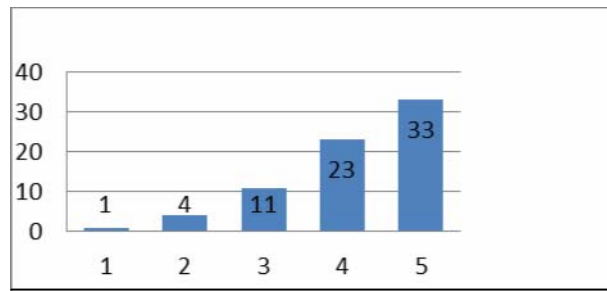


**Figure 2:** Informing people about the concept of sustainable development

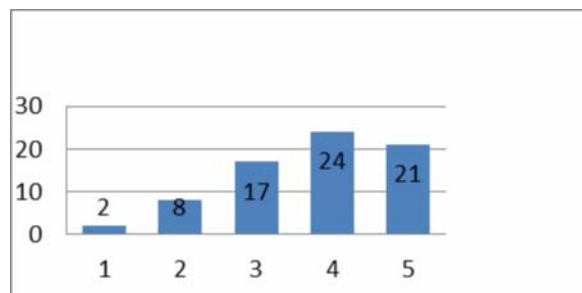
<sup>10</sup>Dejan Jovanov, Vladimir Šiper, Mirjana Dželetovic, Aleksandra Vasilić, Radislav Žeravica, Local Environmental Action Plan of Zrenjanin, p. 15th



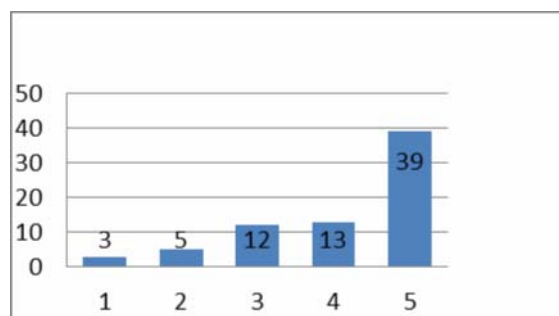
**Figure 3:** Opinion of the populations on the importance of sustainable development in the municipality of *Zrenjanin*



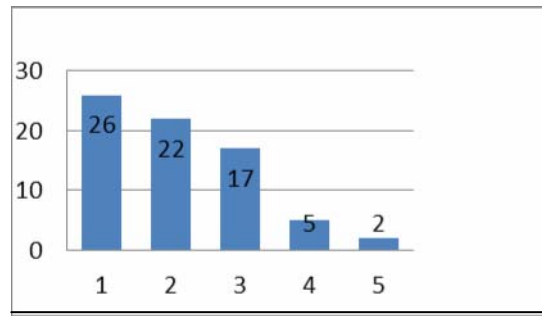
**Figure 4:** Opinion of the population of the contribution of sustainable development to improve the lives of people



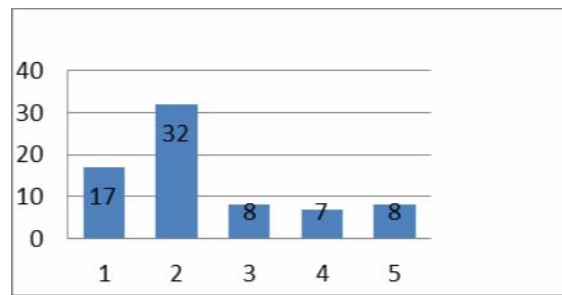
**Figure 5:** Opinion of the population of the contribution of sustainable development of economic factors in Zrenjanin



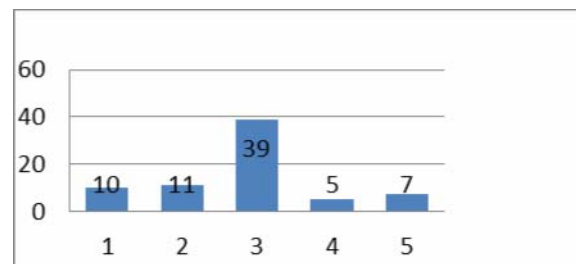
**Figure 6:** Opinion of the population of the contribution of sustainable development for the environment in the municipality of Zrenjanin



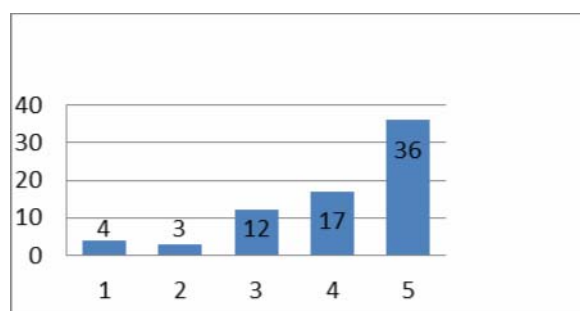
**Figure 7:** Opinion of the population on the level of awareness of people about sustainable development



**Figure 8:** Opinion of the population of the contribution of human factors to sustainable



**Figure 9:** Opinion on population changes of human consciousness on sustainable development



**Figure 10:** Opinion of the population on the need to motivate individuals by the state for a better understanding of sustainable development

Protecting the environment

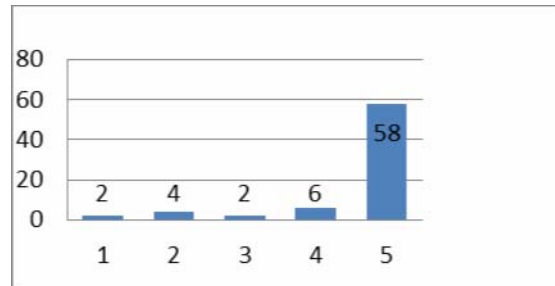


Figure 11: Informing people about the term "Protecting the environment"

Respondents who gave a positive answer to the previous question gave the following answers to the question "What is for you the concept of environmental protection?"



Figure 12: Defining the concept of environmental protection by the respondents

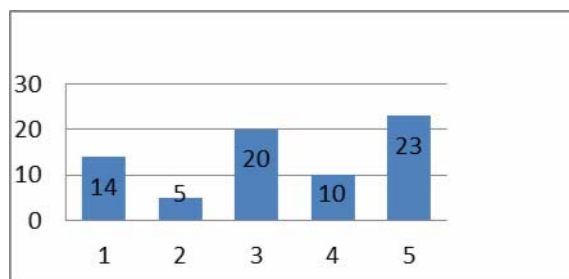
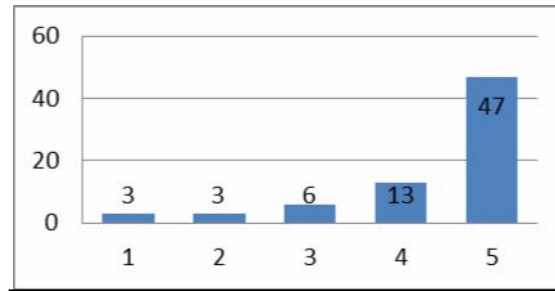
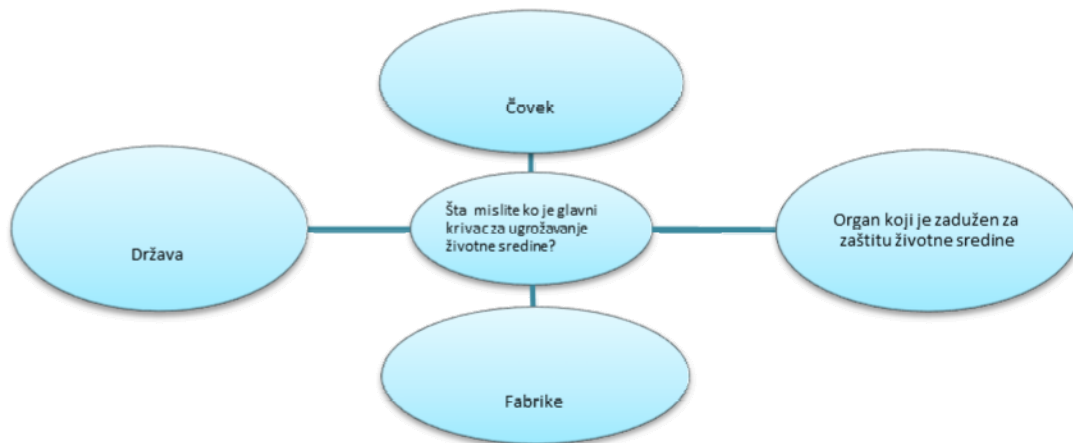


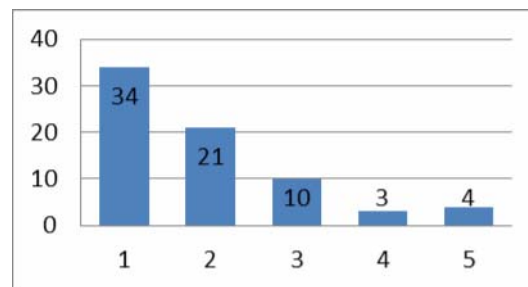
Figure 13: Informing people about the existence of the competent authority for environmental protection in the municipality of Zrenjanin



**Figure 14:** Opinion of the population on the need for greater emphasis on environmental protection in the municipality of Zrenjanin



**Figure 15:** Opinion of people about who is to blame for endangering the environment



**Figure 16:** Opinion of people about whether the awareness of the environment is sufficiently developed among citizens

## CONCLUSIONS

How we succeed to secure a healthier future for generations, it is essential that the entire global community of people connected, "action the rescue of the Earth." In order to achieve something like this, it is necessary to raise awareness of sustainable development at a much higher level than he is now. More specifically, the present time is very low awareness of the sustainable development, which has the effect pollution daily living environment.

In the near future in it is necessary to the municipality of Zrenjanin put increasing emphasis on sustainable development through environmental protection, to future generations, ensure better living conditions.

## REFERENCES

- [1] Internet literature , <http://www.zrenjanin.rs/> , downloaded from the website of 21.05.2013
- [2] Internet literature , <http://sr.wikipedia.org/> , accessed on 15.01.2013 .
- [3] Prof.dr . Miroslav Lambic , Prof. dr. Živorad Milosevic , Prof.dr. Vid Kopanja Mr.Lidija Milosevic , "Ecology and energy, " An energy efficiency of Bosnia and Herzegovina Banja Luka, 2009 , page. 3
- [4] Mr. Dragoljub Todić , Dr. Vukasović Vid , " International organizations and international cooperation in the field of environment ' , Novi Sad , page. 15
- [5] The Law on Environmental Protection of the Republic of Serbia , Article 13
- [6] Sustainable Development ( 2008) . Excerpt from a lecture by Prof. . Dr. Milan Pavlovic , Zrenjanin
- [7] Kula , E. (1998 ) History of Environmental Economic Thought . London and New York : Routledge .
- [8] Internet literature , <http://www.odrzivezajednice.org/> , accessed on 15.01.2013 .
- [9] Prof. . Milan Pavlovic, Sustainable Development, excerpt from a lecture , Zrenjanin , 2008<sup>th</sup>
- [10] Mr. Dejan Jovanov , Vladimir Šiper , Dr. Mirjana Dzeletovic , Aleksandra Vasilić, Radislav Žeravica , Local Environmental Action Plan of Zrenjanin , page . 15<sup>th</sup>

## PROBABILITY OF OCCURRENCE OF MALFUNCTION

Ivan Palinkaš, Danijela Vojnović, Biljana Goševski

University of Novi Sad, Technical Faculty „Mihajlo Pupin“, Zrenjanin, Serbia

e-mail: ivanpalinkas@gmail.com

**Abstract:** In this work we represent mathematical model and fault tree analysis to determine probability of occurrence of malfunction on some technical system. The nature of system is irrelevant. Models can be applied on any process. Work show importance of determine specific malfunctions, that can lead to system malfunction, and importance of calculating probability of occurrence of malfunction in order to improve maintenance to provide better functionality of technical system.

**Key words:** malfunction, mathematical probability, fault tree analysis

### INTRODUCTION

The aim of maintenance is to provide functionality of technical systems. We should try to keep the systems and their functionality, and not only operational aspect used by operators. Redundancy improves functional reliability but also increases the costs of life cycle in the sense of preparations and keeping the level of work of technical systems.

Types of malfunctions are specific malfunctions of equipment which result in functional malfunction of a system and/or a subsystem. Dominant types of system malfunction are those which are responsible for importance of proportion of all malfunctions within them. Not all the types or causes of malfunctions justify preventive maintenance or maintenance according to the condition due to low probability rate in their appearance and their inconsistent effect. For addressing technical content, analysts and planners have to establish if the existing maintenance activities cover all identified potential types of malfunctions and result in desired/expected levels of reliability. Type of malfunction must be envisaged or the existing maintenance activities will not be effective in identifying type of malfunction. Later, it can result in incorrect identification in distribution of fundamental probability in malfunction of function. A lot of information can be proved or upgraded through reliability checks.

### MATERIAL AND METHODS

Reliability can be presented as probability of a unit to function successfully in a defined operational period under specific operational conditions, without malfunctions, which is usually expressed as a life cycle, period until malfunction, or period between two malfunctions. Conditional probability in appearance of malfunction measures probability of a unit with defined operational period of work without occurrence of “state of malfunction” which will eventually lead to malfunction within the interval. If the conditional probability of occurrence of malfunction increases with time elapsed, technical system will show characteristics of wearing out. Level or frequency of malfunction is relatively insignificant for maintenance program, being too simple to be measured. Frequency of malfunctions is useful for the process of decision making regarding expenses, as well as for establishing maintenance intervals, but gives us no information on what maintenance activities are suitable or which, on the other hand, will be a consequence, i.e. result of malfunction. Solutions regarding malfunctions should be estimated within sphere of safety and economic consequences which we want to prevent. Maintenance activities must be applicable, with the aim of their efficiency.

In Table 1. a possible method of quantifying probability of malfunction is presented. In case historical data is available, “powerful“ tool for establishing rank can be provided. In case historical data is not available, ranking can be estimated based on experience with similar systems within a company.

Contemporary maintenance methods are focused on a whole technical system. They are meant more for maintenance of functionality of whole system than functionality of its components. Reliability is the base for making decision. Characteristics of malfunction of technical systems must be understood in order to establish efficiency of preventive maintenance. For successful realization it is necessary to



constantly search for knowledge of conditional probability in occurrence of malfunction in specific time period (possibility that malfunction will occur in every supposed operational period). We should always consider safety first, and then economic reasons. Safety must always be preserved. When safety is out of question, preventive maintenance must be based on economic reasons.

**Table 1.** Categories of probability in occurrence of malfunction

<b>Rank</b>	<b>Effect</b>	<b>Description</b>
1.	1/10000	Small probability of occurrence of malfunction, i.e. it would be unreasonable to expect it
2.	1/5000	Low probability of occurrence of malfunction, similar to previous plans in the past which had low level of occurrence of malfunction for given volume / load
3.	1/2000	Low probability of occurrence of malfunction, similar to previous plans in the past which had low level of occurrence of malfunction for given volume / load
4.	1/1000	Accidental occurrence of malfunction, similar to previous plans in the past which had low level of occurrence of malfunction for given volume / load
5.	1/500	Medium probability of occurrence of malfunction, similar to previous plans in the past which had low level of occurrence of malfunction for given volume / load
6.	1/200	Medium – high probability of occurrence of malfunction, similar to previous plans in the past which had low level of occurrence of malfunction for given volume / load
7.	1/100	High probability of occurrence of malfunction, similar to previous plans in the past which had high level of occurrence of problems
8.	1/50	High probability of occurrence of malfunction, similar to previous plans in the past which had high level of occurrence of problems
9.	1/20	Very high probability of occurrence of malfunction, almost certain to cause a problem
10.	1/10	Very high probability of occurrence of malfunction, almost certain to cause a problem

### **Reliability theory – mathematical model**

Reliability theory is a part of applied mathematics that explores the methods of calculation of system reliability, methods of evaluating the reliability of finished products, and optimization and increase the efficiency of complex technical systems and their components in the process of exploitation (including storage and transport).

The basic concept of reliability theory is failure – gradual or immediate loss of functional ability of the device. At any point in time technical system is in a particular state  $x(t)$ . The set of all possible states of the system is the phase space  $X$ . State of the system can be described with a single, finite or infinite numerical parameters. Over time the system state  $x(t)$  changes (evolution of the system state) depending on the operating conditions – thermal and mechanical stress, aggressive environment,... During this time associated point of the phase space is describing a trajectory. A device that does not work also loses the properties, it ages under influence of moisture, dust, bacteria, etc.. The set  $X$  is allocated a subset of  $A$  such that if the system comes in one of the states of  $A$ , it is considered that the system failed. Experience shows that the function  $x(t)$  can be regarded as a random process.

Reliability is a property of the system to constantly keep working ability. It can be expressed quantitatively: Reliability  $R(t)$  is the probability that for time  $t$  the process does not reach the set  $A$

$$R(t) = P(s > t), R(t) = (N - n) / N$$

where is  $s$  time until first failure;  $N$  is number of elements in moment  $t$ ,  $n$  is number of failed elements in some experiment. The unreliability is the probability of failure

$$F(t) = P(s < t) = n / N, F(t) + R(t) = 1$$

Swedish scientist Weibull, with extensive studying of behavior of nodes has obtain an approximate distribution of their unreliability

$$F(t) = 1 - e^{-ct^a}, t \geq 0, c > 0, a > 0$$

A special case of his distribution is exponential distribution

$$F(t) = 1 - e^{-ct}$$

that, under specific conditions, well describe longevity of technical systems.

Another feature of the reliability is ability of technical system to work in a long period of time with fulfilled conditions of proper technical maintenance, including current and capital repairs, and the cost-effectiveness of further use. Most of the products longevity is a necessary condition for their industrial production.

Function for intensity of failure is

$$L(t) = F'(t) / R(t)$$

and can be interpreted as density of failure distribution. With accuracy up to infinitely small of higher order, the product  $L(t)h$  is equal to the probability that a system or product, failed in the time interval from  $t$  to  $t + h$ , provided that it has worked time  $t$ .

Function failure intensity of the product by rule has the form as shown in Figure 1.



Figure 1. Function of intensity of failure [2]

For Weibull distribution is

$$L(t) = cat^{a-1}$$

With increasing complexity of the system, the greater is the need to develop better mathematical models.

### Fault Tree Analysis and Event Tree Analysis

A fault tree analysis (FTA) is a deductive, top down method of analysing system design and performance and is sometimes used in QRA. It involves specifying a top event to analyse, such as a fire, followed by identifying all of the associated elements in the system that could cause that top event to occur.

Fault trees provide a convenient symbolic representation of the combination of events resulting in the occurrence of the top event. Events and gates in fault tree analysis are represented by symbols.

FTAs are generally performed graphically using a logical structure of AND and OR gates. Sometimes certain elements or basic events may need to occur together in order for the top event to occur. In this case these events would be arranged under an AND gate, meaning that all of the basic events would need to occur to trigger the top event. If the basic events alone would trigger the top event then they would be grouped under an OR gate. The entire system as well as human interactions would be analysed when performing a fault tree analysis. The primary events of a high-order tree may be the top events of lower order trees.

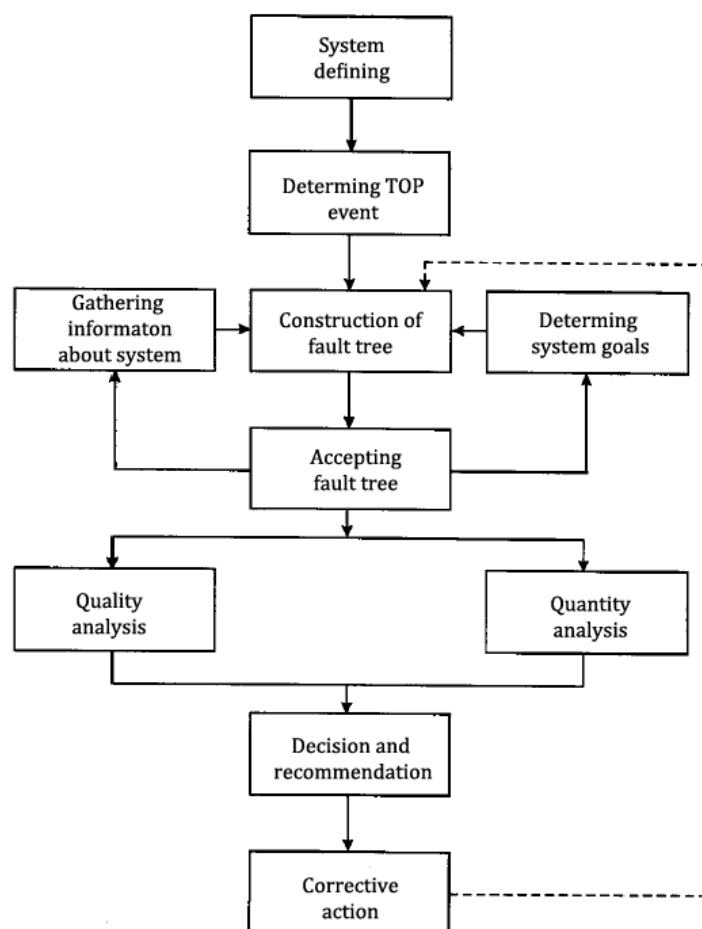
Besides fault trees, event trees can be used in QRA. An event tree is a simple model that shows an "initiating event" for a potential accident, i.e. it shows how an accident scenario might start, for instance, with a pipe break. Safeguards that are designed to prevent or mitigate the accident are also shown (for example a relief valve or backup cooling system). Again, event trees would require to be developed with extra cost. [1]

### Fault tree analysis methodology

The methodology includes failure analysis [4] determination of adverse event, introduction of the system to be analyzed, the fault tree construction scheme, the acceptance of fault tree analysis,

structural evaluation scheme; providing recommendations and alternatives for decision making. Schematic representation of the methodology of failure analysis system is shown in Figure 2.

Adverse event is one that aims to prevent, and that is of primary importance, and that is the unintended result. Logical and complete analysis can be performed only by a complete knowledge system, its composition and data elements and their relationships. All information should be obtained and evaluated. Such documents include schematic drawings, technical scheme of the procedure, diagrams, manuals for operation and maintenance, and so on. First, it exposes how the system under consideration is to operate as normally. On the basis of this review can be enumerated the ways in which elements of the system may fail which leads to adverse events. Keeping records of incidents that led to the poor performance of manufacturing or unexpected downtime can be useful. This is usually reflected in the report on the production and maintenance, and in the technical reports. From these reports we can provide insight about the cause of poor functioning and production losses. According to these documents it can be determined the probability of input events that will allow you to calculate the probability of adverse events. One should be careful in determining the probability that the event was failed by the human factor.



**Figure 2.** Failure analysis methodology [4]

After the specified adverse event, compiles the analytical scheme using logic circuits and standardized symbols of the event. One must go to the appropriate logic to ensure that all events meet the necessary and sufficient criteria. Every event is important for logic Scheme (required), and no other information is required (enough) to get the above output. All other events are excluded as irrelevant or add a primary or lower right. This procedure leads to the development of the scheme clients with Boole logical drive that connect events that could give the above output. The resulting scheme clients should satisfy the purposes intended. Operation of the system should be fully described clearly, and events at the entrance of logic circuits need to be necessary and sufficient.

After the approval of the scheme of fault tree, its study can be both qualitatively and quantitatively. Qualitative assessments related to roads linking the adverse event. If necessary, propose changes to the system. In this, install the appropriate risks and the application of the most effective controls to prevent adverse events. Quantitative estimates are made using appropriate statistical techniques to determine the likelihood of adverse events with these possible paths. From the results, one can propose various recommendations and alternative solutions corrective changes, decisions on control procedures, modification, repair and risk-taking, and so on.

After defining adverse events in the next lower order schemes included are those events that are necessary for the removal of unwanted events. Then, after the order of each of these events separated into constituent parts in order to detect those events that contribute to adverse events.

## RESULTS AND DISCUSSION

On this basis it can be concluded that with FTA we can determine parts of the technical system where we can reduce probability of occurrence of malfunction. The methodology of FTA presented in the paper, can be applied in many areas of technology. There are numerous examples in practice where it has been shown that it can be effectively applied.

For the application of this methodology, it's required to have a complete knowledge of the analyzed system and its component elements, their technological connections, as well as related information.

## CONCLUSION

Probability of occurrence of malfunction represent important topic in system analysis. It has impact on improving and cost-reduction maintenance. Fault tree represents one of the tools for determining and reducing occurrence of malfunction.

Fault tree is constructed in the form of logical progression, based on knowledge of the system components and inductive reasoning.

Compared to other models of the theory and practice applied to reduce probability of occurrence of malfunction, there is an obvious advantage of the application of Boole algebra and its laws, which describe the connection and possible events or logical relationship of logical AND and OR by car or by standardized symbols, and end of logical relations. Hence, it must understand the logical structure of the observed structure of the system.

In the design of technological systems and processes is necessary to take into account the required reliability as one of the important data, given that today the design from the standpoint of reliability is under-represented in practice by designers.

## REFERENCE

- [1] The International Marine Contractors Association, Guidance on Failure Modes & Effects Analyses (FMEAs), IMCA M 166, April 2002.
- [2] Bjelica M., Pouzdanost sistema
- [3] Ramović R., Pouzdanost sistema elektronskih, telekomunikacionih i informacionih, Katedra za Mikroelektroniku i tehničku fiziku, Beograd, 2005.
- [4] Pejović B., Tadić G., Jotanović M., Tomić M., Mičić V., Jedan model za analizu i proračun pouzdanosti primenjen na primeru iz hemijske industrije – stručni rad, Univerzitet u Istočnom Sarajevu, Tehnološki fakultet, Zvornik, Bosna i Hercegovina, 2010., pp. 139-148

## AUTOMATIC DIAGNOSTIC CONTROL OF THE CONDITION OF THE SYSTEM

Ivan Palinkaš, Vojin Kerleta

University of Novi Sad, Technical Faculty „Mihajlo Pupin“, Zrenjanin, Serbia

e-mail: ivanpalinkas@gmail.com

**Abstract:** This work represents the possibility of automatic diagnostic control of system condition. In present, mobile communications and the internet have become an integral part in human life. Using these technologies, we can implement a system that will monitor and inform us about the state of the system considered, wherever we are. This allows us, in case of failure or irregularity in system operation to quickly react and to eliminate defects and faults of the monitored system. Also, the data allow us to provide easier maintenance of the system, and thus reduce the cost of maintaining and monitoring the system.

**Key words:** automatic diagnostic control, remote monitoring, remote access

### INTRODUCTION

Intensive development of IT technologies has enabled a qualitatively new approach to the problem of automatic control of a technological process, and likewise the path of automatic diagnostic control of the condition of the system. The generation of process computers has been developed with considerable advantages in relation to the commercially developed computers. Main pattern of a process computer system for controlling the condition of the system is shown in Figure 1.

In this way the following can be monitored: bearing temperature, bearing vibrations, temperature and pressure of lubricating oil, rotor vibrations (specific), axial displacement of the rotor, relative rotor elongation, bearing housing dilatation, level in the oil tank, iron and copper temperature of the generator stator, temperature of the cooling water, drop in the pressure at the pump suction line, cooling water flow, etc.

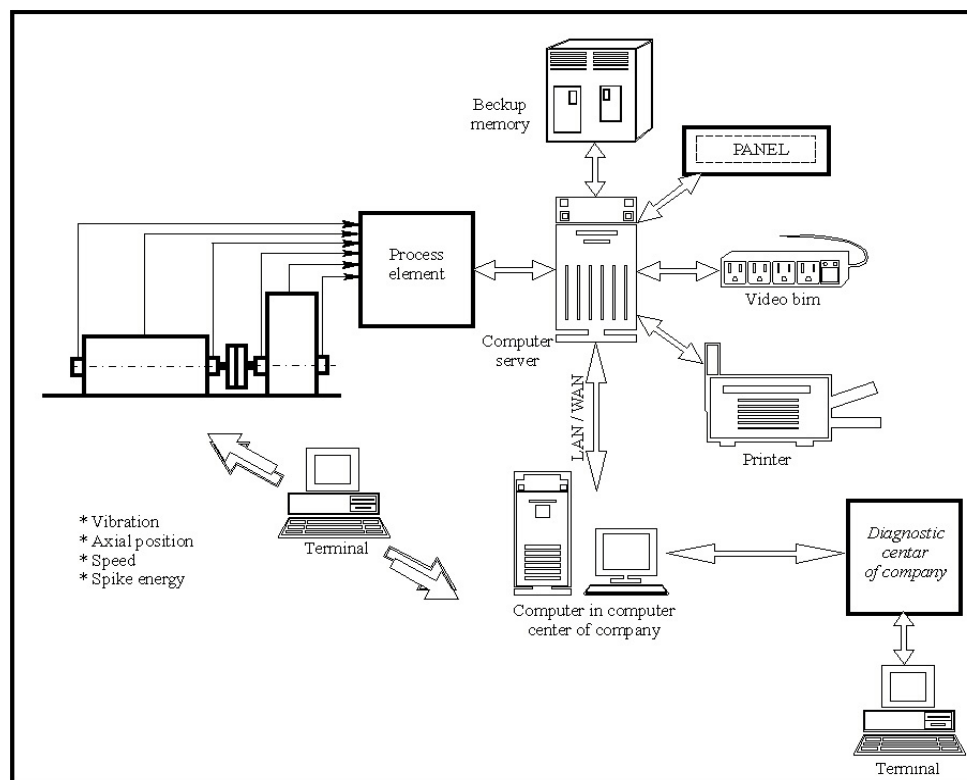


Figure 1. Main pattern of the computer system fir the control of the condition of the system

Thus, the majority the methods of diagnostics of the condition can be reduced to the systematic application of monitoring the following: vibrations, thermal state, lubricant control, corrosion, etc., which cover a wide area of application, while some methods correlate with special types of technical systems. Today, in steel industry worldwide, in 80% of the cases for the analysis of the condition of the system is used the method of vibrations and it is used for the control of the condition of: all power transmission, hoisting devices and cranes, rotary presses, conveyors, piston engines, systems for continuous steel casting, agglomeration systems, systems for oxygen production, etc.

## **MATERIAL AND METHODS**

### **Application of remote monitoring of diagnostic parameters in practice**

Remote monitoring has found its first application in electricity transmission and distribution network, which is by nature spatially chopped up system. Information on the state of the technical system is still mostly still in practice today loading up on the spot.

For many systems there is a possibility of remote monitoring of system parameters, which in the past was specific and dependent on the manufacturer and therefore their data collection and processing have caused additional costs. Faster access to or reading data using routines Oscillography current and voltage or device information such as contact time or internal pressure switch was in the past, although in principle feasible, was the exception though sometimes this information may contribute to the localization of errors or even its elimination.

### **Models of remote access technical systems**

Most of the current automation system is easy to configure and offers a wealth of data on the status of which can be controlled. However, most of this information is only available locally, which makes the integration of such systems into centralized control and management information systems. To overcome this problem it is necessary to allow for remote access control system. System for remote monitoring must meet the following criteria:

- transparency (to provide the image of the complete processes and delivers timely information on the current process)
- openness (ability to integrate into systems, ie. ability to exchange information with systems operating in other protocols)
- stability (upgrade option at minimal cost, and to thereby maintain the functionality of the system)

The goal of every remote control that is remotely controllable parameters. Supervision should enable maintenance personnel to detect problems in time and organize their removal. The main goal is to make preventive interventions prevent interruptions in the unit to be monitored.

Mobile communications and the Internet have become an integral part of everyday life. Also products that surround us use these technologies and offer features such as remote add new content and remote diagnostics using this interface from any location in the world. All of these additional features are possible solutions for remote access and potentially improving the automation of digital systems because they allow simple interface to system management information and reduce the need for human presence at the site. Seen from the hardware point of view, two simple solutions for remote access modems and Ethernet cards; software from the point of view that the TCP / IP, SMS or solutions based on own developed protocols.

### **Application of remote access in process automation**

Remote monitoring is a system where a person (the user), which supervises and monitors the process that are not directly connected, but are used to interconnect communication system. The role of the communication system is a fast, trustworthy transmission of information between two or more points. Remote monitoring does not apply to wireless data. Remote unit of technological processes simply

networking in public or private wired or wireless network. A common case is that the location that should be supervised there made wireline infrastructure. In this case, we rely on a wireless network. Easy to implement local area networks, but with them you can reach longer distances. Another possibility is the use of public mobile networks (Telecom, Telenor, VIP in Serbia).

The power plant near Belgrade, all substations are connected to a central monitoring and control system (SCADA Wonderware in Touch). Supervision and management of heat substations from the web browser, as well as the SCADA system (Figure 2., And Figure 3.). Substations are the nodal points in the mains. They are equipped with components such as circuit breakers, grounding, transformers, and other measuring equipment. A favorable option is to use these systems remotely diagnose and monitor using Internet technologies. Information on switches, transformers are continuously monitored, either directly or via fieldbus and stored in the database. From this database data is then made available to the user via a web browser via intra, extra and the Internet. Remote monitoring of parameters is found wide application in elektodistribuciji to personal maintenance and service users have the information about the quality of supply. Typical events that accompany the large phase deviation, transit surges, power outages, voltage exceeding the limit and so on.

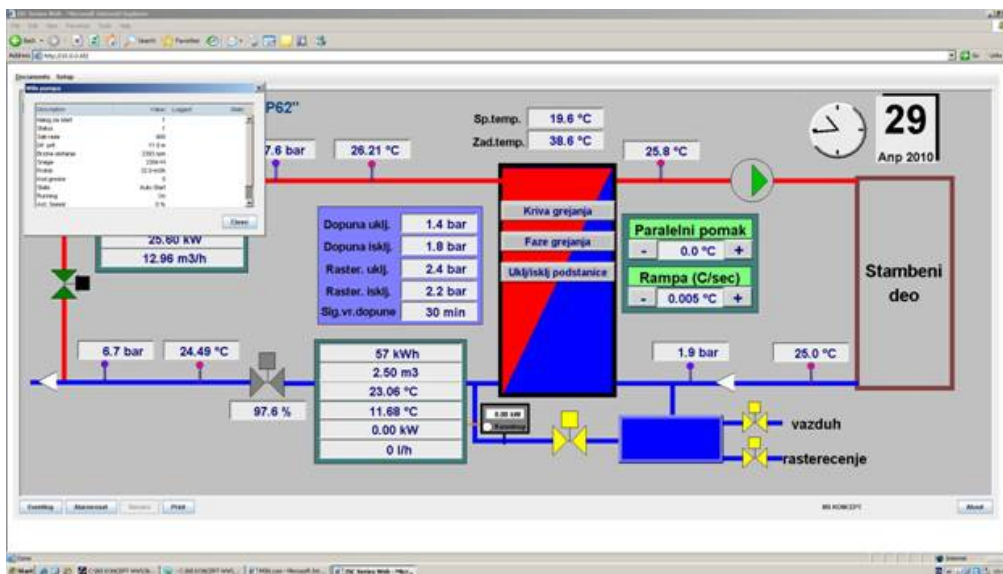


Figure 2. Remote monitoring and control of heat substation in Obrenovac via Web browser [2]

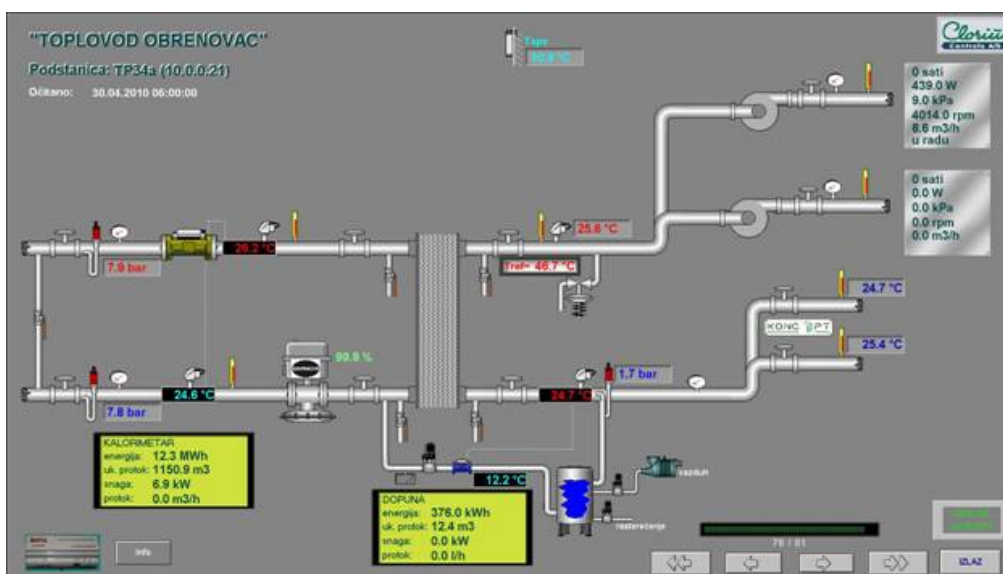


Figure 3. Remote monitoring and control of heat substation in Obrenovac via SCADA

Telediagnostic center may be intended for early warning in the event of abnormal operating conditions of machines and equipment in the plant and thus contribute to the availability and reliability of the entire plant. Siemens offers both. Power Diagnostics Services as telediagnostic center for steam turbogenerator. Telediagnostic process steam turbo generator starts collecting data which are of interest for diagnosis. Telediagnostic center uses tools to simultaneously collect and obtain operational data. Figure 4 shows the flow of data from the remote systems to the remote telediagnostic center. This configuration is designed to meet the needs of data security. Data prior to entry into the remote diagnostic center passing through the area checking data, and the database is protected by a firewall.

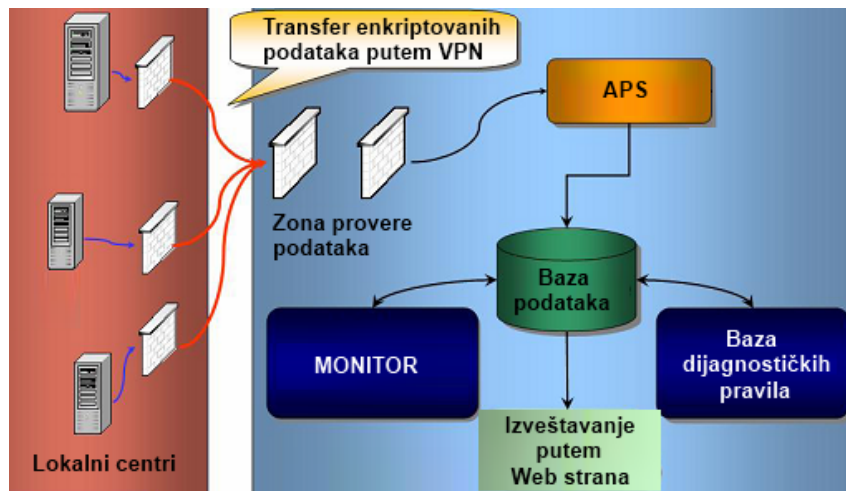


Figure 4. Data flow from remote turbo generators to telediagnostic center [1]

## RESULTS AND DISCUSSION

### The structure of the system for remote monitoring

The structure of the system in an industrial setting usually consists of a central control center and several remote units, which operate independently, but are linked into a whole. Type of applied technology of remote monitoring based on need, purpose, available equipment, the required compatibility, distance, you can set the communication system...

Remote units are equipped with PLC, input – output modules and an appropriate communication interface. Control unit is a communication center, where you can monitor events from all remote units or only GSM terminal, using it to track important events.

Digitally driven processes are already more than 20 years implemented for the collection and processing of diagnostic data, management, control and monitoring, and data that have a protective purpose. Remote access to this data eg. Evaluation of setting regulatory circuits or failure analysis time, it was in the past, can be realized only with specific hardware and software manufacturers. This conditionality is true only when it is in this particular case in a remote village and mounted through a modem over a telephone line connected to the technical system.

Next difficulties in many existing systems that process conditions such as. temperature and pressure, the processing system may be required, but fully informed information eg. associated with the calibration, maintenance history and maintenance needs, but is available in the technical system and often only on specific devices for programming.

To avoid problems with quality in optimization and flow control are often closed control circuits, which assumes availability over time regulation size or appropriate good indexes. While this information from the site is already available, require complex manufacturing processes, eg. in the chemical industry or specific knowledge of experts, who can no longer be at a local manufacturing plant.



## CONCLUSION

Remote monitoring enables access eg. group of experts in a decentralized business enterprise, mobile maintenance personnel on the road between the parts of systems or monitoring systems after the change process from the user. Internet technologies allow therefore in addition to access to information, as well as new forms of maintenance and work organization.

The next big advantage of web application technology : without any cost information can be integrated from multiple sources in a common form. This allows you to show the measured process variables together with the processing scheme of the technical system. In general, the use of remote access technical systems have the following advantages: quick support in case of delays at remote locations, efficient use of resources, reduce costs and minimize system downtimes.

## REFERENCES

- [1] Radovanović Lj., Maintenance methodologies and their application in industry, doctoral thesis, Technical faculty "Mihajlo Pupin", Zrenjanin, 2012.
- [2] <http://www.nskoncept.rs>

# IN COOPERATION WITH PARTNERS:

UNIVERSITY OF AGRICULTURE, FACULTY OF AGRICULTURAL ENGINEERING , KRAKOW, POLAND



UNIwersytet Rolniczy  
im. Hugona Kolltaja w Krakowie

TECHNICAL UNIVERSITY-SOFIA, PLOVDIV BRANCH, THE FACULTY OF MECHANICAL ENGINEERING,  
PLOVDIV, BULGARIA



„AUREL VLAICU” UNIVERSITY OF ARAD, FACULTY OF ENGINEERING, ARAD, ROMANIA



UNIVERSITY OF NIŠ, FACULTY OF MECHANICAL ENGINEERING, NIŠ, SERBIA



UNIVERSITY OF EAST SARAJEVO, FACULTY OF MECHANICAL ENGINEERING EAST SARAJEVO,  
B&H, REPUBLIC OF SRPSKA



UNIVERSITY «St. KLIMENT OHRIDSKI«, TECHNICAL FACULTY, BITOLA, MACEDONIA

